

Assembly Instructions

KETTLER

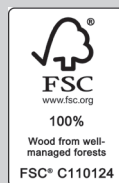

elba Dining Table 220x100cm

0393103-0100/0200



IMPORTANT

PLEASE KEEP THIS BOOKLET FOR FUTURE REFERENCE.
THIS IS IMPORTANT INFORMATION REGARDING THE USE AND
CARE OF YOUR GARDEN FURNITURE.









ASSEMBLY
TIME

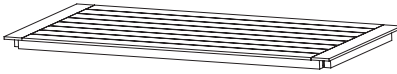

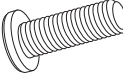
PERSONS
REQUIRED

Parts List

<p>(A) Table Top</p>  <p>x1</p>	<p>(B) Legs</p>  <p>x4</p>	<p>(C) Washer</p>  <p>x8</p>	
<p>(D) Bolt M8 x 45 (mm)</p>  <p>x8</p>	<p>(E) Bolt Cover</p>  <p>x8</p>	<p>(F) Allen Key</p>  <p>x1</p>	<p>(G) Spring Washer</p>  <p>x8</p>



Do not discard any of the packaging until you have checked that you have all the parts and the pack of fixings.

Helpful advice before you begin:

1. We suggest you spend a short time reading through this leaflet and then follow the simple step by step instructions.
2. Do not discard any of the packaging until you have checked that you have all the parts and the pack of fittings.
3. Assemble this product on a soft surface.
4. To ensure an easier assembly, we strongly advise that all fittings are only finger tightened during initial assembly. Only upon completion of the assembly should all fixing points be fully tightened.
5. Keep fittings out of children's reach.
6. Do not use any other tools other than those recommended to build this product.
7. Please do not use substitute parts. Use only additional or replacement parts supplied by Kettler.
8. In the unlikely event that this product has missing or damaged parts, please visit our website www.kettler.co.uk

Assembly

1

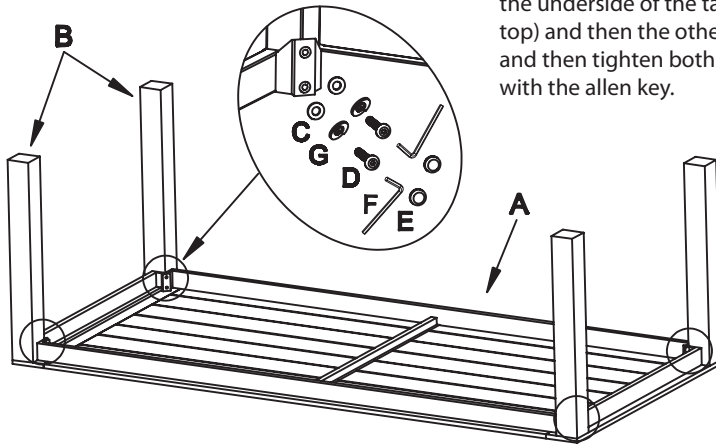

First hand tighten the bottom screw (nearest to the underside of the table top) and then the other and then tighten both with the allen key.

2

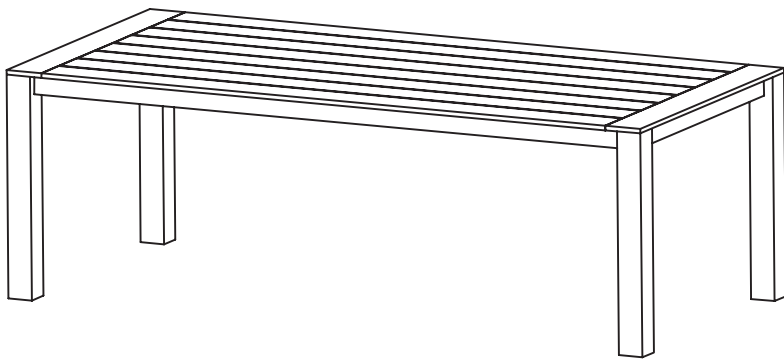

Finished

Maintenance and Care Instructions

- This product may only be used for its intended purpose for residential premises. Any other uses may affect the warranty.
- We recommend that you follow these simple tips and instructions to ensure it retains its good looks. Remove food and drink residue, tree sap and bird droppings as soon as possible to avoid staining. Marks should be removed using neat mild detergent with a soft cloth and washed off with water. Do not leave hot items directly on the table. Coasters will protect your table from heat and water rings. Do not drop anything sharp or heavy onto the table. Take care when placing items onto the table to avoid scratches.

We recommend to maintain and lengthen the life of this product you follow the below regime:

On wood areas:

1. Ensure the product is clean. If the product is clean you can go straight to stage 2. Cleaner is only required if it hasn't been treated for 6-12 months.

Use our Hardwood cleaner: First moisten the wood with water. Apply the HARDWOOD CLEANER with a soft cloth or sponge. Allow to soak for 3 minutes. Brush the furniture clean with a scrubbing pad in the direction of the grain. Rinse furniture well with water.

We recommended that you treat your teak furniture with Hardwood cleaner when required.

***** Grey frame with grey teak, go to **step 2**, white frame with natural teak go straight to **step 3**.***

2. Use Instant Grey Protector for elba: Apply a thin layer of Instant Grey Protector with a soft cloth. Allow to dry for 1 hour and then the wood has turned driftwood-grey. (If you wish to have a more intense grey colour, apply a second thin layer).

We recommended that you treat your teak furniture with Instant Grey Protector twice a year April & October.

3. Hardwood Shield on teak: Apply carefully by dabbing (rubbing damages the grey patina). Make sure the Hardwood is 100% dry and free of dust. Apply a thin layer of HARDWOOD SHIELD with a soft cloth. Allow to dry for one hour and then apply a second thin coat of HARDWOOD SHIELD. Let the wood dry for 48 hours before exposure to moisture and rain.

We recommended that you treat your teak furniture with HARDWOOD SHIELD twice a year April & October.

On aluminium parts:

We recommend the Kettler Multi-surface cleaner when necessary.

The Kettler after-care range available is available to purchase from the Kettler website.

Maintenance and Care Instructions

- Moving parts such as locking mechanisms, catches and joints need to be lubricated where necessary.
- Kettler furniture can be covered – we recommend that you use Kettler tailored covers (where available) or universal breathable covers.
- This product is 100% recyclable. At the end of the products life, please dispose of responsibly.
- Colours may vary slightly



Attention

Please be aware that painted/varnished surfaces can be damaged by sunscreens and oil based products. If the surface of your Kettler leisure furniture comes into contact with sunscreens, the surface is to be cleaned without delay as described above.

Only in this way can lasting discolouration of the surface by the ingredients of the sunscreen be prevented.

For Your Safety

- This product may only be used for its intended purpose as furniture for residential properties.
- Check all components regularly for correct function, damage and loose connections especially at the start of the season and at 1-2 month intervals dependent on use.
- Damaged components may endanger your safety or shorten the life of the product. Replace all damaged parts immediately. Use only spare parts manufactured by Kettler. Should you wish to purchase spare parts, they can be ordered directly from: www.kettler.co.uk/shop
- Kettler will not be responsible for damaged caused by improper use.



Attention

- Whilst assembling this product keep out of the reach of children. (Choking hazard – contains small parts)
- Ensure that your working area is free of possible sources of danger, for example don't leave any tools lying around.
- Always dispose of packaging material in such a way that it may not cause any danger. There is always a risk of suffocation if children play with plastic bags!
- We reserve the right to make changes for technical reasons.

KETTLER



www.kettler.co.uk



Warranty For Home Use

This product is covered by a 3 year warranty against manufacturing faults. This warranty applies to domestic use only. It does not cover commercial use, mis-use or accidental damage.

To validate your warranty, register at www.kettler.co.uk and quote the product code from the front of this booklet.