

## Product information

- Indoor use only
- Dimmable - when used with dimmable bulbs
- Replacement bulbs should be the same type and rating, available from John Lewis Partners or other established brands
- Clean the fitting with a soft dry cloth. Do not use abrasive chemical cleaners as this will damage the finish

## Aftercare and Troubleshooting

### You've switched on the light, but it's not working:

1. Check your power supply is switched on
2. Turn off the light and check that the bulb is inserted correctly
3. Check the bulb is still in working order

If there are technical issues with this product that you can't solve, please contact your nearest John Lewis & Partners shop or call Technical Support on 03301 230106.

## Specification

Max power: 1 x 7W  
Recommended bulb:  
7W LED E27 GLS bulb for maximum brightness.  
Lower wattages are also suitable.  
Rated input: 220 –240V, 50Hz  
Bulbs not included  
IP rating: 20  
Weight: 1.84kg

## 5-year guarantee

At John Lewis & Partners we test every light to high quality standards. That means we can offer you a 5-year guarantee.

## Recycling

This symbol  indicates that this product should not be treated as normal household waste and it should be recycled. John Lewis & Partners do not operate instore take back, but as members of the Distributor Take Back scheme have funded the development and upgrade of recycling facilities across the UK. Please take it to your nearest collection facility or for further details contact your local council or visit [www.recycle-more.co.uk](http://www.recycle-more.co.uk).

John Lewis plc  
SW1V 2QQ  
[johnlewis.com](http://johnlewis.com)

Made in China



24/07/2024

Please retain these instructions for future reference.



# FACETED METAL 1 LIGHT PENDANT USER GUIDE



Product Code:  
70142507



## Getting started

Thank you for purchasing this John Lewis & Partners product. For your safety, and to make sure everything is working properly, please read the instructions carefully before use.

## Warnings

This is a Class 1 product and must be earthed. It is recommended that this fitting is installed by a qualified electrician. Install in accordance with the IEE Wiring regulations and the Building Regulations. To prevent electrocution switch off at mains supply before installing or maintaining this fitting. Ensure other persons cannot restore the electrical supply without your knowledge. If you are in any doubt, please consult a qualified electrician. This light fitting should be connected to a 5 amp fused circuit. If replacing an existing fitting, make a note of the connections. Always use the correct type and wattage bulb. Never exceed the wattage stated. When changing a bulb always switch off at the mains and allow to cool down. Dispose of used bulbs carefully. This product is suitable for indoor use only. This product is suitable for installation on surfaces with normal flammability e.g. wood, plasterboard, masonry. It is not suitable for use on highly flammable surfaces (e.g. polystyrene, textiles). For your safety, always switch off the supply before changing lightbulbs, cleaning or removing shades. This product is heavy. Therefore take extreme care when installing and cleaning this product, or changing the bulb, to avoid damage or injury.

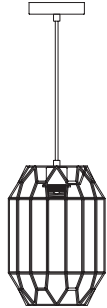
## Parts list

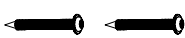
Description	Image	Quantity
Light fitting		x 1
Wall plugs		x 2
Screws		x 2

## Product assembly

### Step 1

Carefully unpack the carton, making sure all the parts are present before assembly. Before removing the existing fitting, carefully note the position of each set of wires.

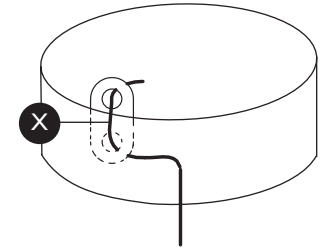

### Step 2

The drop of this product can be reduced and will be easier to complete before attaching the product to the ceiling. Pull the cable through the cord grip (X) until the desired height is achieved.

**Please note:** Do not loosen the screw clamp inside the ceiling cup as this is securing the cable into the terminal block.

### Step 3

Remove the fixing bracket (A) from the ceiling cover by removing the side screws (B) and attach to the ceiling using the screws (C) provided. Ensure there is a joist at the point of fixing to support the weight of the product. Take care to avoid damaging any concealed wiring and pipes.

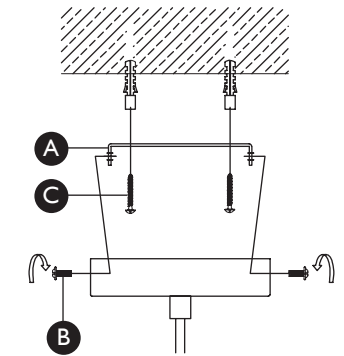

### Step 4

Connect the product to the household wiring. Check that: You have correctly identified the house wires. The connections are tight. No loose strands have been left out of the connection block. When completed, ensure that there are no bare or loose strands of wire exposed.

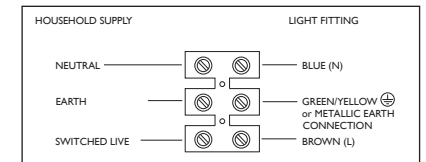

### Step 5

Re-attach the product to the fixing bracket and tighten the side screws. Take care not to trap any wiring. Fit the recommended bulb (D) into the product. Replace fuse or circuit breaker and switch on. Your light is now ready for use.

