

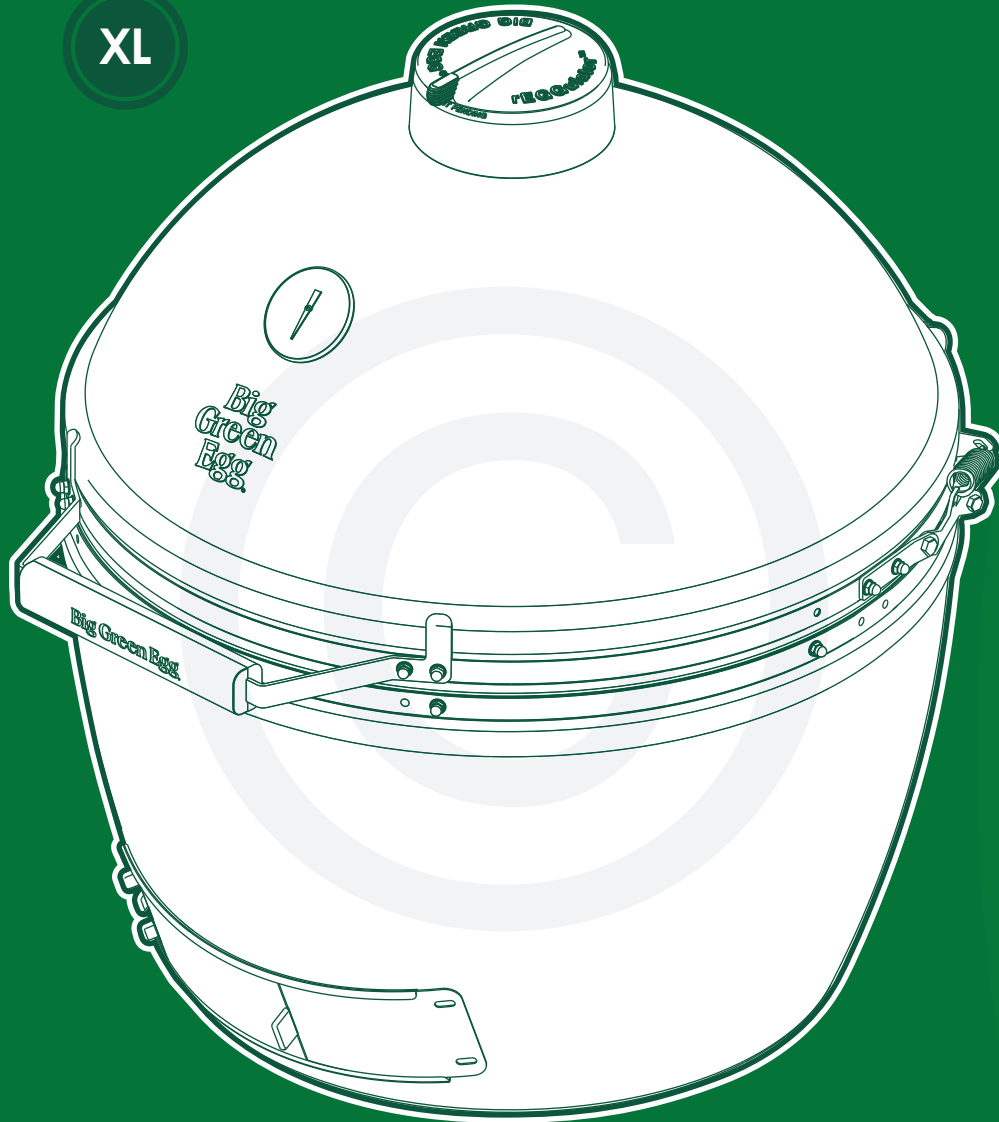

# EGG® & Band

XL

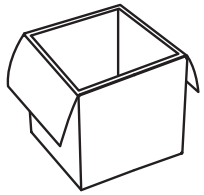



7/16" + 1/2"  
(11mm + 13mm)



[www.biggreenegg.com/assembly-videos](http://www.biggreenegg.com/assembly-videos)

 [www.biggreenegg.com](http://www.biggreenegg.com)

 [www.biggreenegg.ca](http://www.biggreenegg.ca)

 [www.biggreenegg.eu](http://www.biggreenegg.eu)

 [www.biggreenegg.co.uk](http://www.biggreenegg.co.uk)

 [www.biggreenegg.com.au](http://www.biggreenegg.com.au)

 [www.biggreenegg.co.nz](http://www.biggreenegg.co.nz)

 [www.biggreeneggisrael.com](http://www.biggreeneggisrael.com)

 [www.biggreenegg.com.mx](http://www.biggreenegg.com.mx)

 [www.biggreenegg.co.za](http://www.biggreenegg.co.za)



**CAUTION: SEE SAFETY NOTICE**  
[www.biggreenegg.com/safetytips](http://www.biggreenegg.com/safetytips)



Intertek

Conforms to:  
UL Std 2182 &  
NSF/ANSI 4

Certified to:  
ULC ORD Std C2162



Intertek

5008505

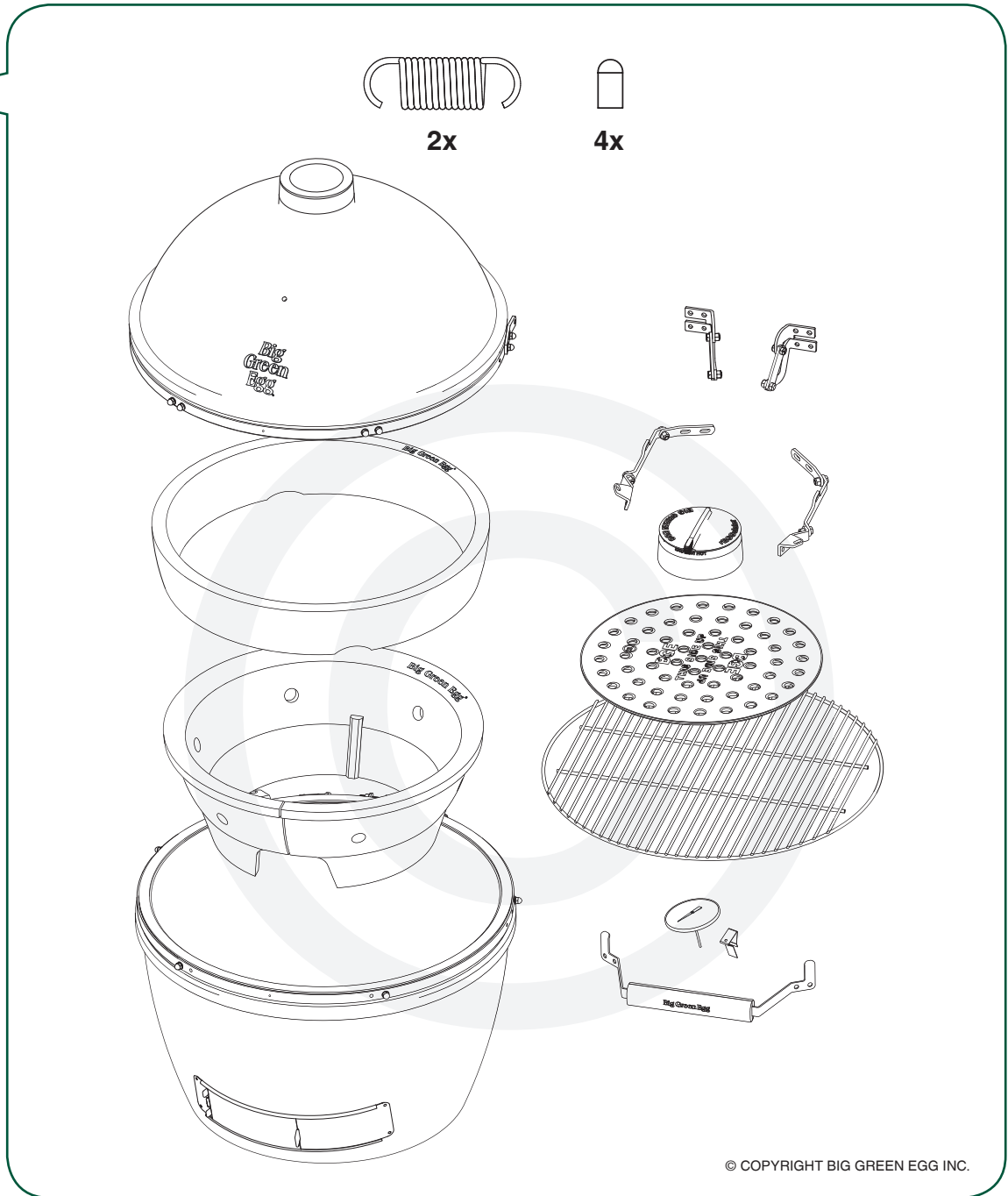

© COPYRIGHT BIG GREEN EGG INC.

## COMMERCIAL USE REQUIREMENTS AND WARNINGS

**MANUFACTURER:** THE BIG GREEN EGG, INC. | ATLANTA, GEORGIA  
**CLEARANCES FROM COMBUSTIBLES:** 14" sides and back | 36" front

**MODEL:** Big Green Egg  
**NON-COMBUSTIBLE FLOOR PROTECTION DIMENSIONS:** 30"x36"

**VENTILATION:** This cooking equipment is to be provided with an exhaust hood tested for compliance with the Standard for Ventilation Control and Fire Protection of Commercial Cooking Operations, NFPA 96, with the requirements in the Standard for Exhaust Hoods for Commercial Cooking Equipment, UL 710. **Canadian Requirement:** The Big Green Egg is to be provided with an exhaust hood tested for compliance with the National Building Code of Canada and the National Fire Code of Canada, or the requirements of CAN/ULC-S646 / Cet appareil de cuisson doit être pourvu d'une hotte d'aspiration qui a été soumise à l'essai aux fins de conformité avec le Code national du bâtiment du Canada et le Code national de prévention des incendies du Canada, ou avec les exigences de la norme CAN/ULC-S646. **Australia Requirement:** See Guidance Note by the Croydon Council for Class A2/A4/A5, the Australia EPA and Department for Administration and Information Services known as EPA 122/11.

**INSTALLATION AND OPERATION:** Please refer to Manufacturer's installation and operation instructions for precautions, clearances, and to ventilation supplier's minimum required air flows required for installation of the exhaust hood, and references to building codes for details. **CAUTION:** Do not over fire – When flame spills out of the EGG, you are over-firing. **Canada:** Ne pas surchauffer – lorsque des flammes jaillissent à l'extérieur du four, c'est qu'il y a surchauffe. To reduce the risk of creosote fire: Inspect EGG twice monthly and clean when necessary. **Canada:** Pour réduire le risque d'incendie causé par l'accumulation de créosote – inspecter le four deux fois par mois et le nettoyer au besoin. Install and use only in accordance with manufacturer's installation and operating instructions. **Canada:** Installer et utiliser seulement conformément aux directives d'installation et de fonctionnement de nom du fabricant. Contact local building officials or fire officials about restrictions and installation inspection in your area. **Canada:** Communiquer avec les agents du bâtiment ou les agents de service d'incendie au sujet des restrictions et de l'inspection de l'installation dans la région. For use with natural lump charcoal fuel only. **Canada:** Pour utilisation avec du bois de (lump charcoal). Do not fill required air space with insulation or other materials. **Canada:** Ne pas remplir le vide d'air d'isolant ou d'autres matériaux.

**FABRICANTE:** The Big Green Egg, Inc. | Atlanta, Georgia  
**DISTANCIA A MATERIALES COMBUSTIBLES:** 14" a los lados y la parte trasera | 36" al frente

**MODELO:** Big Green Egg  
**DIMENSIONES SOBRE PISO NO COMBUSTIBLE:** 30" x 36"

**VENTILACIÓN:** Este equipo de cocina se proveerá con una chimenea de salida probada para el cumplimiento de las normas de ventilación y protección contra incendio de equipo comerciales de cocina, normas NFPA 96 o según los requisitos de las normas de salida de gases para equipos comerciales de cocina de las normas UL 710. **Requisitos de Canadá:** The Big Green Egg se proveerá con una chimenea de salida de gases que cumpla con las normas nacionales del código de construcción de Canadá y las normas nacionales contra incendio de Canadá o los requisitos de las normas CAN/ULC-S646. **Requisitos de Australia:** Véase la Nota de orientación del Consejo Croydon para Clase A2/A4/A5, la EPA de Australia y el Departamento de Servicios de Administración e Información conocido como EPA 122/11. **INSTALACIÓN Y USO:** Consultar las instrucciones de instalación y uso del fabricante para ver los detalles sobre precauciones, distancias de seguridad y circulación mínima de aire exigidas para la instalación de la chimenea de salida y las referencias a códigos de edificación. **PRECAUCIÓN:** No intensificar el fuego: Si las llamas salen del EGG significa que el fuego es demasiado intenso. Para reducir el riesgo de incendio de creosota: Inspeccionar el EGG dos veces por mes y limpiarlo cuando sea necesario. Instalar y usar la unidad según las instrucciones pertinentes del fabricante. Consulte con las autoridades competentes en su zona sobre las restricciones de uso y la inspección de la instalación. Para uso exclusivamente con carbón. No rellenar los espacios con materiales aislantes ni de otro tipo.

1

1a

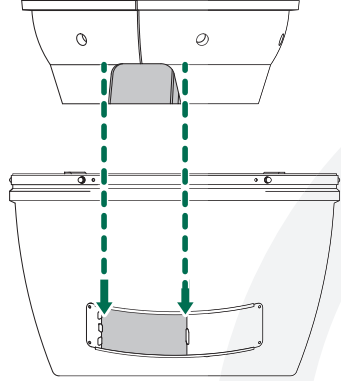

1e

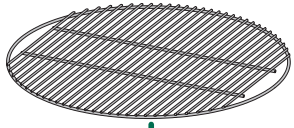

1d

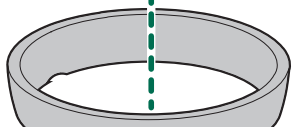

1c

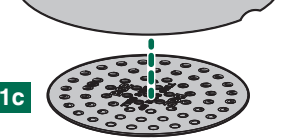

1b

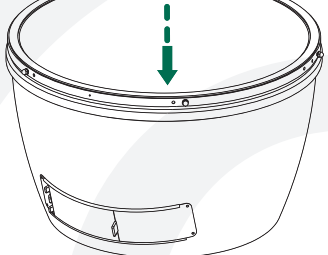
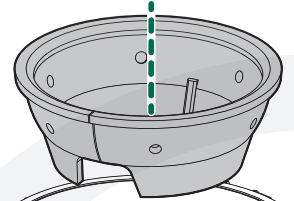

2

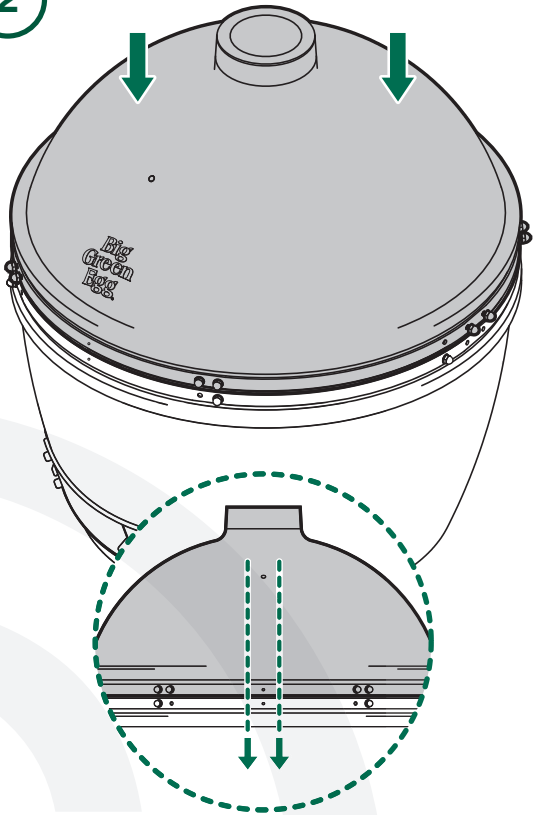

3

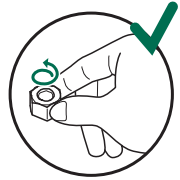

20x

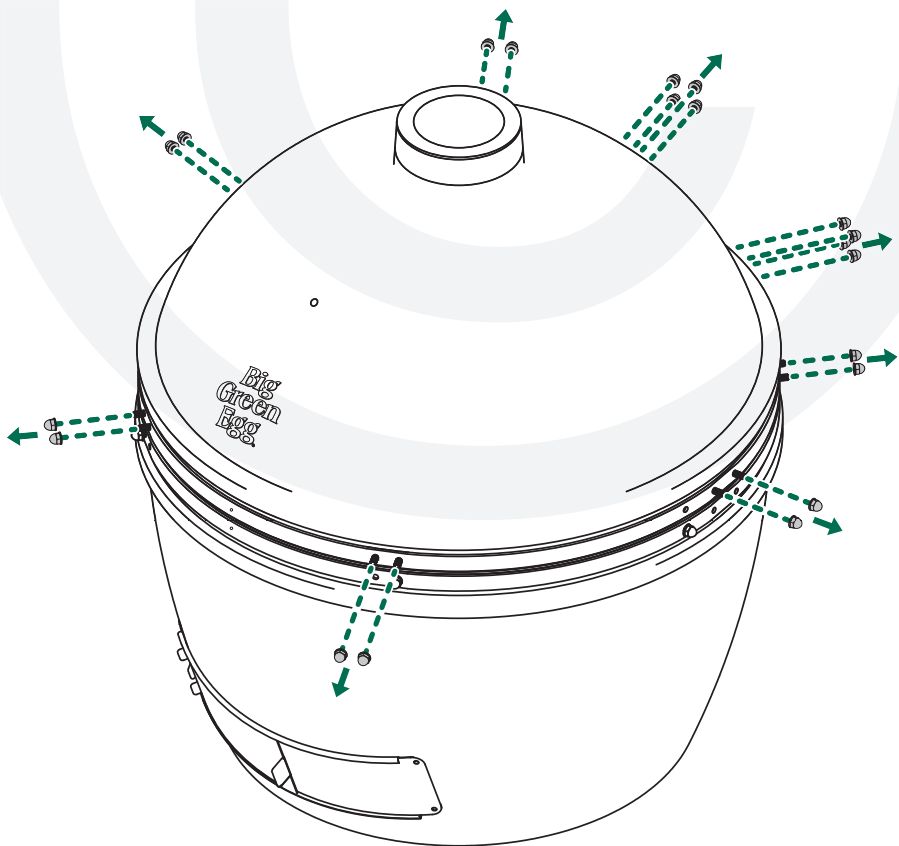

4



16x

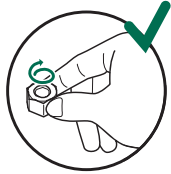

16x

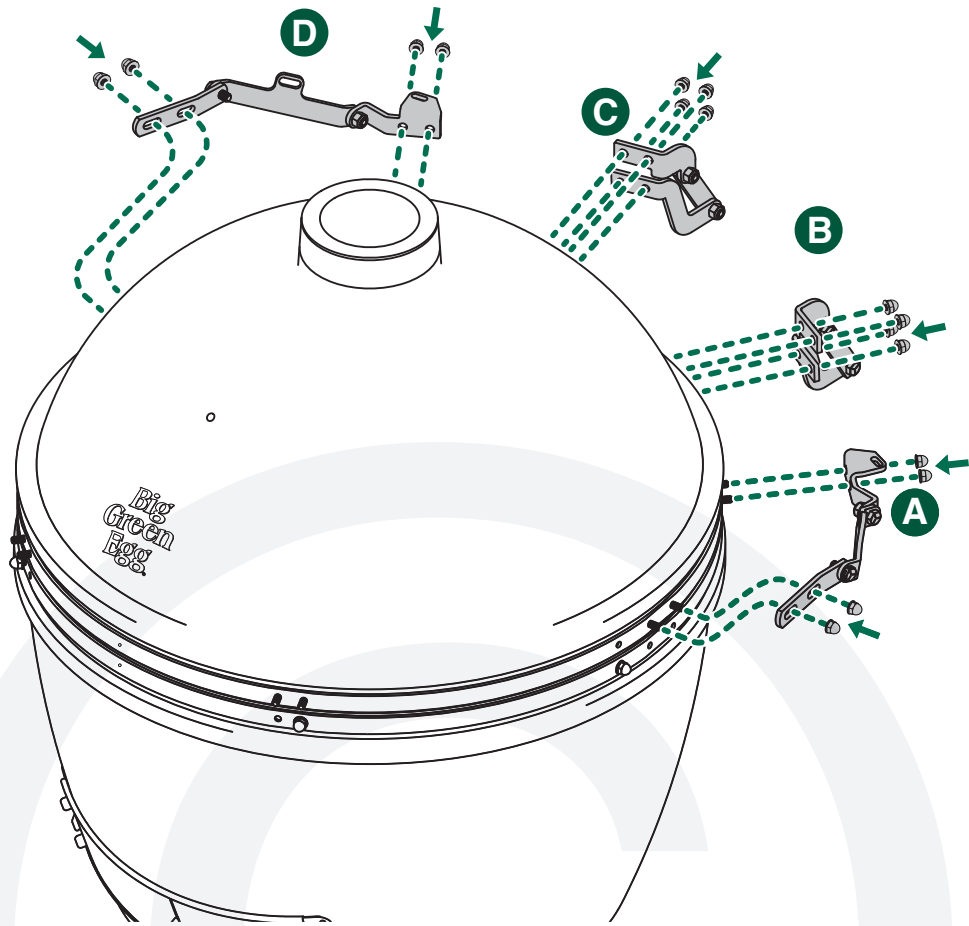

5



4x



4x

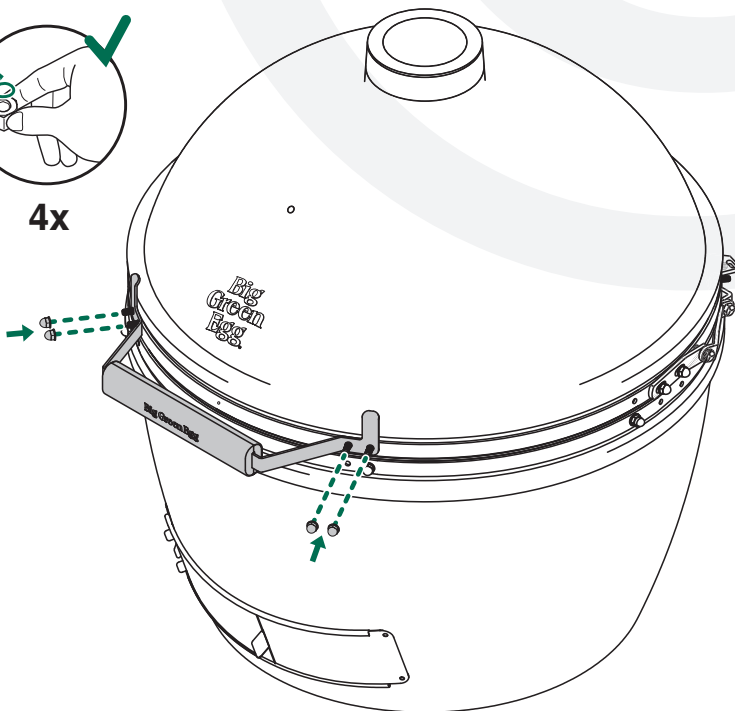

6



7/16" (11mm)

