



Caring for your product	We recommend cleaning with a soft dry cloth. Do not use abrasive materials as these will damage the finish. Indoors use only.
Aftercare and Troubleshooting	<p>Why is the light not working when switched on?</p> <p>Check your power supply is switched on Turn off light and check that the bulb is inserted correctly Check the bulb is still in working order.</p> <p>Replace bulbs from John Lewis or established brand of the same type and compatibility</p> <p>If you experience any unresolvable technical issues with the product, contact your nearest John Lewis & Partners shop or John Lewis & Partner Technical Support on 03301 230106.</p>
Specification	<p>Recommended bulb: SES energy efficient LED candle bulb or SES eco halogen candle bulb Max. power: 3x40W Bulb not included Voltage: 220 –240V, 50Hz IP rating: 20 Weight: 1.85kg</p> <p>CE</p>
5 year guarantee	At John Lewis & Partners we test every light to high quality standards so we are able to offer you a 5 year guarantee.
Recycling	<p>This symbol  indicates that this product should not be treated as normal household waste and it should be recycled. John Lewis & Partners do not operate instore take back, but as members of the Distributor Take Back scheme have funded the development and upgrade of recycling facilities across the UK. Please take it to your nearest collection facility or for further details contact your local council or visit www.recycle-more.co.uk.</p> <p></p>
John Lewis Partnership 171 Victoria Street London SW1E 5NN johnlewis.com Made in China	Please retain these instructions for future reference.



EMPIRE CRYSTAL PENDANT USER GUIDE

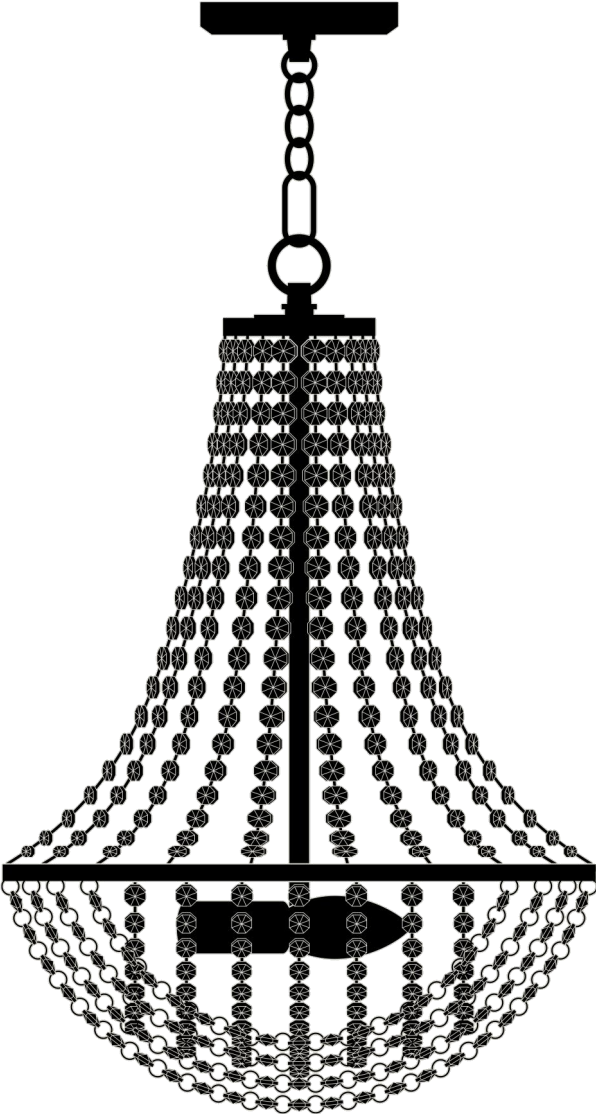

Introduction

Thank you for purchasing this Empire Crystal Pendant.
Please read the instructions carefully before use to ensure safe and satisfactory operation of this product.

Warnings



This product is Class I and must be earthed.

This fitting should be fitted in accordance with IEE Regulations and the Building Regulations. If in any doubt, or where required by law, consult a competent person who is registered with an electrical self-certification scheme. Further information is available online or from your Local Authority. To prevent electric shock, switch off at the mains supply before installing or maintaining this fitting. Ensure other persons cannot restore the electricity supply without your knowledge. If you are in any doubt, please consult a qualified electrician.

It is the installer's responsibility to ensure that the fixings and plugs used are suitable for the surface you are fixing your product on.

If replacing an existing fitting, make a note of the connections. Always use the correct type and power bulb. Never exceed the power stated. When changing a bulb, always switch off at the mains and allow the old bulb to cool down before handling. Dispose of used bulbs carefully.

The flexible cable on this luminaire, if damaged, shall only be replaced by the manufacturer or his service agent or a similar qualified person.

Caution! The bulb and surrounding parts can become hot during

Parts list

Description	Image	Quantity
A Raw plug		2
B Fixing screw		2
C Fixing bracket		1
D Connector block		1
E Grub screw		2
F Ø 330 Lamp body		1
G Allen key		1

Product assembly

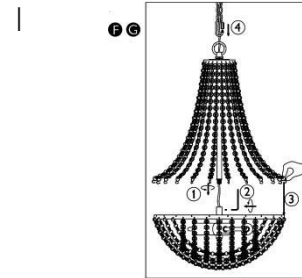

Ensure the mains electricity supply switched off at the fuse board.

Step 1

If removing an existing fitting, note down all wiring connections.

Put the centre rod into the top of the lampholder base, and then secure with grub screw using Allen key (provided)

Hang the crystal chains to the metal frame one by one.

2

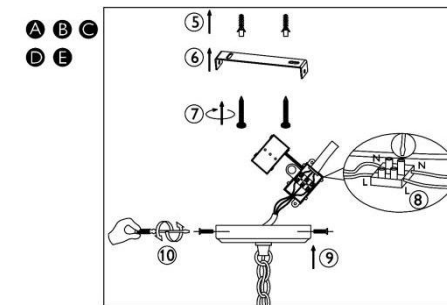

Step 2

Ensure that the bracket (supplied) is fixed to a wooden joist in the ceiling using screws (supplied) or use a suitable fixing to the ceiling which will support the weight of the fitting.

The weight of the fitting must be supported by the suspension bracket and not the flexible cable.

Adjust the chain to the required length, ensure the cable is longer than the chain, feed the flexible cable through the chain links and into the ceiling cup. Ensure that no strain is placed on the cable.

Connect cables to terminals as shown below.

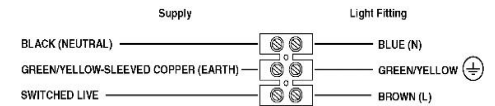

Check all wires are tight in the terminal block and no loose strands are left out.

Cover with insulating tape (not included).

Step 3

Push up ceiling cup and secure with grub screws provided

3

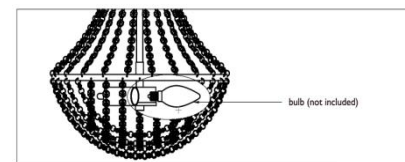

Step 4

Attach the correct type and wattage bulb to the lamp holder (bulb not included).

The maximum power indicated must not be exceeded.

Switch on the electricity supply at the fuse board.