



KETTLER

Cora 150 cm Round Dining Table

HUC28207



IMPORTANT

PLEASE KEEP THIS BOOKLET FOR FUTURE REFERENCE.
THIS IS IMPORTANT INFORMATION REGARDING THE
USE AND CARE OF YOUR GARDEN FURNITURE.









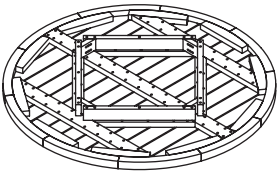
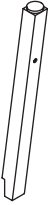
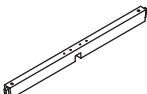

ASSEMBLY
TIME

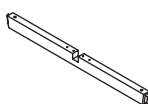

PERSONS
REQUIRED

Parts List

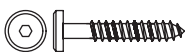
<p>(A) Table Top</p>  <p>x1</p>	<p>(B) Legs</p>  <p>x4</p>	<p>(C) Brace Rail 1</p>  <p>x1</p>	<p>(E) Bracket</p>  <p>x1</p>
		<p>(D) Brace Rail 2</p>  <p>x1</p>	
<p>(1) Bolt M6x100 (mm) with Nuts</p>  <p>x4</p>	<p>(2) Bolt M8x70 (mm)</p>  <p>x8</p>	<p>(6) Allen Key</p>  <p>x2</p>	
<p>(3) Washers</p>  <p>x8</p>	<p>(4) Plastic Caps</p>  <p>x4</p>	<p>(5) Screw M6x30 (mm)</p>  <p>x8</p>	



Do not discard any of the packaging until you have checked that you have all the parts and the pack of fixings.

Helpful advice before you begin:

1. We suggest you spend a short time reading through this leaflet and then follow the simple step by step instructions.
2. Do not discard any of the packaging until you have checked that you have all the parts and the pack of fittings.
3. Assemble this product on a soft surface.
4. To ensure an easier assembly, we strongly advise that all fittings are only finger tightened during initial assembly. Only upon completion of the assembly should all fixing points be fully tightened.
5. Keep fittings out of children's reach.
6. Do not use any other tools other than those recommended to build this product.
7. Please do not use substitute parts. Use only additional or replacement parts supplied by Kettler.
8. In the unlikely event that this product has missing or damaged parts, please visit our website www.kettler.co.uk

Assembly

1

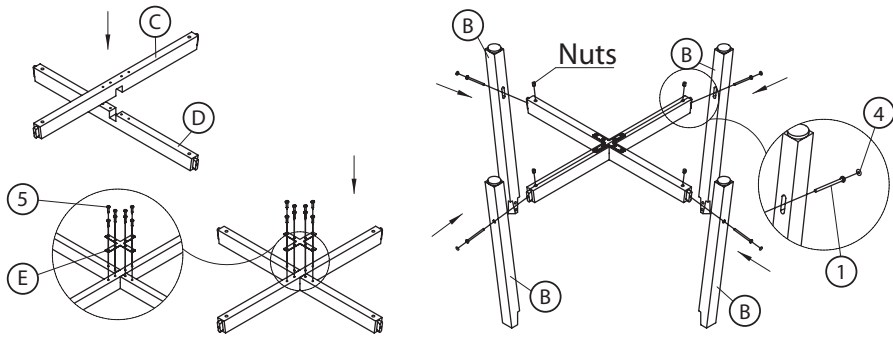

2

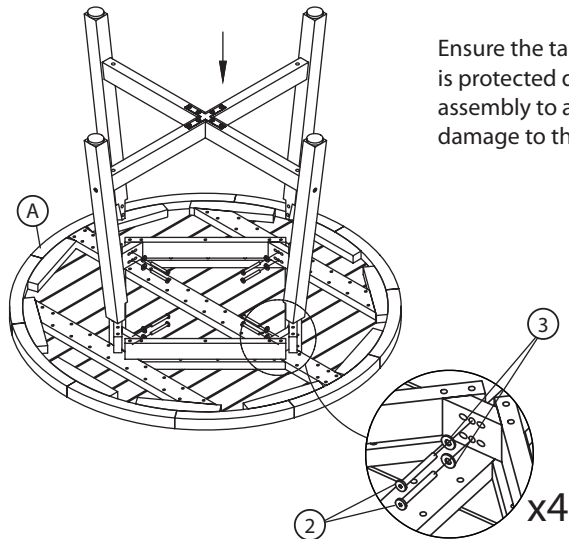

Ensure the table top is protected during assembly to avoid damage to the surface

Assembly

3

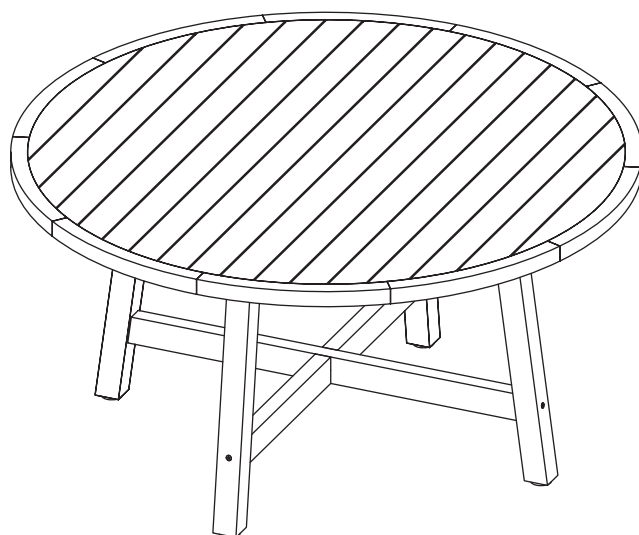

Finished



Attention

Please be aware that painted/varnished surfaces can be damaged by sunscreens. If the surface of your Kettler leisure furniture comes into contact with sunscreens, the surface is to be cleaned without delay as described above. Only in this way can lasting discolouration of the surface by the ingredients of the sunscreen be prevented.

Maintenance and Care Instructions

This product may only be used for its intended purpose for residential premises. Any other uses may affect the warranty.

To maintain and lengthen the life of this product, we recommend the following regime:

- Kettler furniture is designed to be left outdoors all year round (excluding cushions). Cushions should be stored in a dry ambient temperature when not in use.
- Remove dust regularly with a clean soft brush and wipe down with a clean damp cloth.
- For tables - Use pads, mats and coasters under plates, glasses cups etc to protect them from scratches, spills, stains and heat damage. Wipe spills immediately to prevent staining.
- Tree sap and bird droppings should be cleaned off immediately with warm soapy water.

Wood Treatment:

1. Ensure the product is clean. If the product is clean, you can go straight to stage 2. Cleaner is only required if it hasn't been treated for 6-12 months.

Use Hardwood cleaner: First moisten the wood with water. Apply the HARDWOOD CLEANER with a soft cloth or sponge. Allow to soak for 3 minutes. Brush the furniture clean with a scrubbing pad in the direction of the grain. Rinse furniture well with water.

We recommended that you treat your wooden furniture with Hardwood cleaner when required.

2. Use Instant Smoke White Protector for Cora: Apply a thin layer of Instant Smoke White Protector with a soft cloth.

Allow to dry for 1 hour and then the wood has turned smoke white. (If you wish to have a more intense colour, apply a second thin layer).

We recommended that you treat your furniture with Instant Smoke White Protector twice a year (April & October).

3. Hardwood Shield: Apply carefully by dabbing. Make sure the hardwood is 100% dry and free of dust. Apply a thin layer of HARDWOOD SHIELD with a soft cloth. Allow to dry for one hour and then apply a second thin coat of HARDWOOD SHIELD. Let the wood dry for 48 hours before exposure to moisture and rain.

We recommended that you treat your furniture with HARDWOOD SHIELD twice a year (April & October).

The Kettler after-care range available is available to purchase from the Kettler website: www.kettler.co.uk

Failure to comply with the outlined care instructions will result in the warranty being invalidated.

- Moving parts such as locking mechanisms, catches and joints need to be lubricated (where necessary).
- Storage: During Winter/wetter months store in a cool, dry and well ventilated location to prevent excessive shrinkage or expansion of the wood. Alternatively cover the furniture with a Kettler tailored cover (where available) or use a universal breathable cover.
- This product is 100% recyclable. At the end of the products life, please dispose of responsibly.
- Colours may vary slightly



For more information view our 'How-To' and maintenance videos: kettler.co.uk/how-to-guides

For Your Safety

- Check all components regularly for correct function, damage and loose connections especially at the start of the season and at 1-2 month intervals dependent on use.
- Damaged components may endanger your safety or shorten the life of the product. Replace all damaged parts immediately. Use only spare parts manufactured by Kettler. Should you wish to purchase spare parts, they can be ordered directly from: www.kettler.co.uk/shop
- Kettler will not be responsible for damaged caused by improper use.



Attention

- Whilst assembling this product keep out of the reach of children. (Choking hazard – contains small parts)
- Ensure that your working area is free of possible sources of danger, for example don't leave any tools lying around.
- Always dispose of packaging material in such a way that it may not cause any danger. There is always a risk of suffocation if children play with plastic bags!
- We reserve the right to make changes for technical reasons.

KETTLER

www.kettler.co.uk



PlanetMark



Warranty For Home Use

This product is covered by a 3 year warranty against manufacturing faults. This warranty applies to domestic use only. It does not cover commercial use, mis-use or accidental damage.

To validate your warranty, register at www.kettler.co.uk and quote the product code from the front of this booklet.