

Recommended bulb

5 x 3-6 Watt E27 energy efficient LED

or

5 x 28 Watt E27 eco halogen capsule

Bulb not included

Specification

Max power: 40W

Voltage: 220~240V, 50/60Hz

IP20

Weight 0.9Kg



Please retain these instructions for future reference.

This symbol  indicates that this product should not be treated as normal household waste and it should be recycled. John Lewis does not operate in store take back, but as members of the Distributer Take Back scheme have funded the development and upgrade of recycling facilities across the UK. Please take it to your nearest collection facility or for further details contact your local council or visit www.recycle-more.co.uk.

Trouble shooting:

Why is the light not working when switched on?

Check your power supply is switched on

Turn off light and check that the bulb is inserted correctly

Check the bulb is still in working order.

John Lewis partnership

171 Victoria Street

London SW1E 5NN

Johnlewis.com

Made in China

Issue 1 09/19

John Lewis

User manual HOUSE 5LT SEMI FLUSH

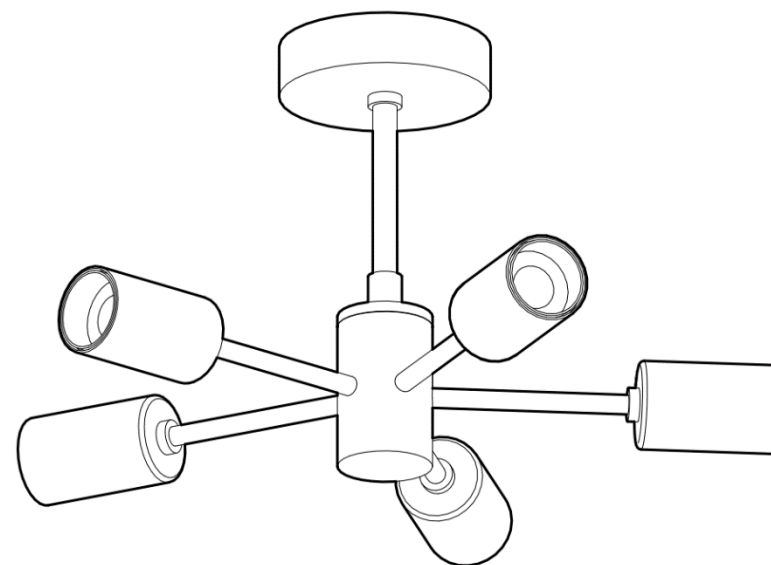

Thank you for purchasing this House semi flush ceiling light. Please read the instructions carefully before use to ensure safe and satisfactory operations of this product. Please keep this instruction for future reference.





Warnings!

For your safety, this product must be installed in accordance with local Building Regulations.
 If in any doubt, or where required by the law, consult a competent person who is registered with an electrical self-certification scheme. Further information is available online or phone your Local Authority.
 To prevent electric shock, switch off the mains supply before installing or maintaining this product. Ensure other persons cannot restore the electricity supply without your knowledge.
 Always use the correct bulb type with the correct wattage as indicated in the specification table. This product is Class II =  and should be fitted to a lighting Supply protected by a 5 amp fuse or equivalent circuit breaker.
 When changing the bulb, always switch off at the mains and allow the old bulb to cool down before handling. Dispose of used bulbs carefully.
Caution! The bulb and surrounding parts can become hot during use.
 For indoor use only.

Care instructions

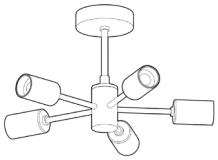
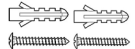
We recommend cleaning with a soft dry cloth. Do not use abrasive materials as these will damage the finish.
 Replace bulb from John Lewis or established brand of the same type and compatibility.

Parts list

| Part List | Qty | Part List | Qty | Part List | Qty |
|--|-----|---|-----|---|-----|
|  | 1 |  | 2 |  | 1 |
| | |  | 2 |  | 1 |

Assembly

Never install your appliance on a wet, freshly painted or plastered surface. Ensure the house electricity supply is switched off at the fuse box. If removing an existing fitting, note down all wiring connections. Check the fixings will not touch any existing wiring before drilling and attaching the light to the ceiling.
 Ensure you thread the ceiling wires through the black insulating tube fixed to the appliance.

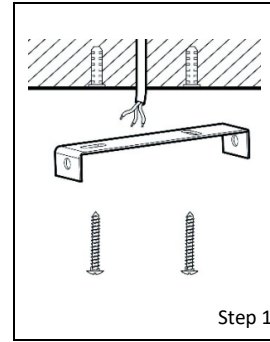

Step 1

Remove mounting bracket from fitting by removing the retaining screws and any washers, retain for later. Using the mounting bracket as a template, mark and then drill the fixing holes in the ceiling (ensure the screws are firmly fixed into a solid or other suitable mounting and not just the plasterboard.) Take care not to damage wiring. Attach mounting bracket to the mounting surface using suitable fixings. Do not attach fitting to mounting bracket at this stage. Make sure no wires are trapped in the process.

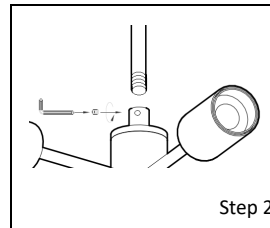

Step 2

Attach the main stem of the fitting into the central hub section by rotation into place. Once the stem has been fully tightened, lock the stem in place by tightening the small hex screw located on the receiving collar using the hex key provided.

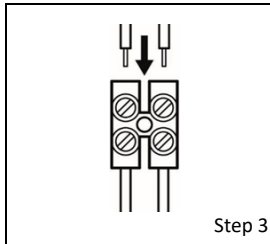

Step 3

Ensuring that the power has been isolated, connect the electrical supply wires to the connector blocks corresponding terminals. Make the electrical connection as follows:

- Connect the supply live (normally brown or red) to fitting live (marked "L") on the terminal block housing.
- Connect the supply neutral (normally blue or black) to fitting neutral (marked "N") on the terminal block housing.

NO EARTH must be connected to any part of this fitting. **Please note** that residential wiring can vary, if you are unsure about the correct polarity please consult a qualified electrician. Ensure electrical connections are tight and no loose strands of wire protrude from the terminal block then close connector block cover by snapping back together.

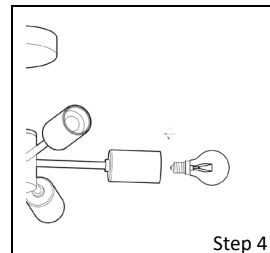

Step 4

Excess cable must be carefully located inside the ceiling cup or within the ceiling cavity itself. Carefully offer fitting over mounting bracket then secure in place with the screws and any washers removed earlier.
Fit the bulb: type and wattage as indicated on the fitting. **The wattage indicated must not be exceeded.**
 Once installation is complete, the house electricity may be restored at the fuse box.