



Built-in oven

[en] INSTRUCTION MANUAL

B57VS24.0B



Table of contents

| | | | |
|---|-----------|--|-----------|
|  Intended use | 4 |  Childproof lock | 21 |
| | | Automatic childproof lock | 21 |
| | | One-time childproof lock | 22 |
|  Important safety information | 5 |  Basic settings | 22 |
| General information | 5 | Changing MyProfile | 22 |
| Steam | 6 | List of basic settings | 22 |
| Cleaning function | 6 | Setting favourites | 23 |
|  Causes of damage | 7 |  Baking and roasting assistant | 23 |
| General information | 7 | Information on the settings | 23 |
| Steam | 7 | Selecting and setting food | 23 |
|  Environmental protection | 8 |  Programmes | 24 |
| Saving energy | 8 | Information about the programmes | 24 |
| Environmentally-friendly disposal | 8 | Selecting and setting the programme | 25 |
|  Getting to know your appliance | 9 |  Sabbath mode | 25 |
| Control panel | 9 | Starting Sabbath mode | 25 |
| Controls | 9 | Cancelling Sabbath mode | 25 |
| Main menu | 10 |  Cleaning agent | 26 |
| Menu for the types of heating | 10 | Suitable cleaning agents | 26 |
| Cooking compartment functions | 11 | Keeping the appliance clean | 27 |
| Water tank | 11 |  Cleaning function | 27 |
|  Accessories | 12 | Self-cleaning | 27 |
| Accessories included | 12 | EasyClean | 28 |
| Inserting accessories | 12 | Descaling | 29 |
| Combining accessories | 13 |  Rails | 30 |
| Optional accessories | 13 | Changing the shelf position for the telescopic rail | 30 |
|  Before using for the first time | 14 | Detaching and refitting the rails | 30 |
| Before using for the first time | 14 |  Appliance door | 31 |
| Initial use | 14 | Removing and fitting the appliance door | 31 |
| Cleaning the cooking compartment | 15 | Removing and installing the door panels | 32 |
| Cleaning the accessories | 15 |  Trouble shooting | 34 |
|  Operating the appliance | 15 | Fault table | 34 |
| Switching the appliance on and off | 15 | Maximum operating time exceeded | 35 |
| Setting and starting the appliance operation | 15 | Cooking compartment bulbs | 35 |
| Changing or cancelling the appliance operation | 16 |  Customer service | 36 |
| Heating up the appliance quickly | 16 | E number and FD number | 36 |
|  Steam | 17 | | |
| Noise | 17 | | |
| VarioSteam – Steam-assisted cooking | 17 | | |
| Dough proving setting | 18 | | |
| Reheating | 18 | | |
| Filling the water tank | 18 | | |
| After every steam operation | 19 | | |
|  Time-setting options | 20 | | |
| Showing and hiding the time-setting options | 20 | | |
| Setting the timer | 20 | | |
| Setting the cooking time | 21 | | |
| Start delay – "Ready at" | 21 | | |
| Checking, changing or deleting settings | 21 | | |

| | | |
|--|--|-----------|
|  | Tested for you in our cooking studio | 36 |
| | Silicone moulds | 36 |
| | Baking | 36 |
| | Roasting and braising | 40 |
| | Grilling | 43 |
| | Convenience products | 46 |
| | Yogurt | 48 |
| | Save energy with Eco heating types | 48 |
| | Acrylamide in foodstuffs | 49 |
| | Slow cook | 49 |
| | Drying | 51 |
| | Preserving | 51 |
| | Allowing the dough to prove at dough proving setting | 52 |
| | Defrosting | 53 |
| | Reheating | 54 |
| | Keeping warm | 54 |
| | Test dishes | 55 |

Additional information on products, accessories, replacement parts and services can be found at **www.neff-international.com** and in the online shop **www.neff-eshop.com**

Intended use

Read these instructions carefully. Only then will you be able to operate your appliance safely and correctly. Retain the instruction manual and installation instructions for future use or for subsequent owners.

This appliance is only intended to be fully fitted in a kitchen. Observe the special installation instructions.

Check the appliance for damage after unpacking it. Do not connect the appliance if it has been damaged in transport.

Only a licensed professional may connect appliances without plugs. Damage caused by incorrect connection is not covered under warranty.

This appliance is intended for domestic use only. The appliance must only be used for the preparation of food and drink. The appliance must be supervised during operation. Only use this appliance indoors.

This appliance is intended for use up to a maximum height of 2000 metres above sea level.

This appliance may be used by children over the age of 8 years old and by persons with reduced physical, sensory or mental capabilities or by persons with a lack of experience or knowledge if they are supervised or are instructed by a person responsible for their safety how to use the appliance safely and have understood the associated hazards.

Children must not play with, on, or around the appliance. Children must not clean the appliance or carry out general maintenance unless they are at least 8 years old and are being supervised.

Keep children below the age of 8 years old at a safe distance from the appliance and power cable.

Always slide accessories into the cooking compartment the right way round.

→ "Accessories" on page 12

Important safety information

General information

Warning – Risk of fire!

- Combustible items stored in the cooking compartment may catch fire. Never store combustible items in the cooking compartment. Never open the appliance door if there is smoke inside. Switch off the appliance and unplug it from the mains or switch off the circuit breaker in the fuse box.
- A draught is created when the appliance door is opened. Greaseproof paper may come into contact with the heating element and catch fire. Do not place greaseproof paper loosely over accessories during preheating. Always weight down the greaseproof paper with a dish or a baking tin. Only cover the surface required with greaseproof paper. Greaseproof paper must not protrude over the accessories.

Warning – Risk of burns!

- The appliance becomes very hot. Never touch the interior surfaces of the cooking compartment or the heating elements. Always allow the appliance to cool down. Keep children at a safe distance.
- Accessories and ovenware become very hot. Always use oven gloves to remove accessories or ovenware from the cooking compartment.
- Alcoholic vapours may catch fire in the hot cooking compartment. Never prepare food containing large quantities of drinks with a high alcohol content. Only use small quantities of drinks with a high alcohol content. Open the appliance door with care.

Warning – Risk of scalding!

- The accessible parts become hot during operation. Never touch the hot parts. Keep children at a safe distance.
- When you open the appliance door, hot steam can escape. Steam may not be visible, depending on its temperature. When opening, do not stand too close to the appliance. Open the appliance door carefully. Keep children away.
- Water in a hot cooking compartment may create hot steam. Never pour water into the hot cooking compartment.

Warning – Risk of injury!

- Scratched glass in the appliance door may develop into a crack. Do not use a glass scraper, sharp or abrasive cleaning aids or detergents.
- The hinges on the appliance door move when opening and closing the door, and you may be trapped. Keep your hands away from the hinges.

Warning – Risk of electric shock!

- Incorrect repairs are dangerous. Repairs may only be carried out and damaged power cables replaced by one of our trained after-sales technicians. If the appliance is defective, unplug the appliance from the mains or switch off the circuit breaker in the fuse box. Contact the after-sales service.
- The cable insulation on electrical appliances may melt when touching hot parts of the appliance. Never bring electrical appliance cables into contact with hot parts of the appliance.
- Do not use any high-pressure cleaners or steam cleaners, which can result in an electric shock.
- A defective appliance may cause electric shock. Never switch on a defective appliance. Unplug the appliance from the mains or switch off the circuit breaker in the fuse box. Contact the after-sales service.

Warning – Hazard due to magnetism!

Permanent magnets are used in the control panel or in the control elements. They may affect electronic implants, e.g. heart pacemakers or insulin pumps. Wearers of electronic implants must stay at least 10 cm away from the control panel.

Steam

Warning – Risk of scalding!

- The water in the water tank may become very hot if you continue to operate the appliance. Empty the water tank after every operation with steam.
- Hot steam is generated in the cooking compartment. Do not reach into the cooking compartment during any operation with steam.
- Hot liquid may spill over the sides of the accessory when it is removed from the cooking compartment. Remove hot accessories with care and always wear oven gloves.

Warning – Risk of injury and risk of fire!

Flammable liquids can catch fire in the cooking compartment when it is hot (explosion). Do not fill the water tank with any flammable fluids (e.g. alcoholic drinks). Only fill the water tank with water or with the descaling solution that is recommended by us.

Cleaning function

Warning – Risk of fire!

- Loose food residues, grease and meat juices may catch fire during the cleaning function. Before starting the cleaning function, remove coarse dirt from the cooking compartment and from the accessories.
- The appliance will become very hot on the outside during the cleaning function. Never hang combustible objects, e.g. tea towels, on the door handle. Do not place anything against the front of the appliance. Keep children away from the appliance.

Warning – Risk of serious damage to health!

The appliance will become very hot during the cleaning function. The non-stick coating on baking trays and tins is destroyed and noxious gases are released. Never clean non-stick baking trays and baking tins using the cleaning function. Only clean enamelled accessories using the cleaning function.

Warning – Risk of burns!

- The cooking compartment becomes extremely hot during the cleaning function. Never open the appliance door or move the locking latch by hand. Allow the appliance to cool down. Keep children away from the appliance.
-  The appliance will become very hot on the outside during the cleaning function. Never touch the appliance door. Allow the appliance to cool down. Keep children away from the appliance.

Causes of damage

General information

Caution!

- Accessories, foil, greaseproof paper or ovenware on the cooking compartment floor: do not place accessories on the cooking compartment floor. Do not cover the cooking compartment floor with any sort of foil or greaseproof paper. Do not place ovenware on the cooking compartment floor if a temperature of over 50 °C has been set. This will cause heat to accumulate. The baking and roasting times will no longer be correct and the enamel will be damaged.
- Aluminium foil: Aluminium foil in the cooking compartment must not come into contact with the door glass. This could cause permanent discolouration of the door glass.
- Water in a hot cooking compartment: do not pour water into the cooking compartment when it is hot. This will cause steam. The temperature change can cause damage to the enamel.
- Moisture in the cooking compartment: Over an extended period of time, moisture in the cooking compartment may lead to corrosion. Allow the cooking compartment to dry after use. Do not keep moist food in the closed cooking compartment for extended periods of time. Do not store food in the cooking compartment.
- Cooling with the appliance door open: Following operation at high temperatures, only allow the cooking compartment to cool down with the door closed. Do not trap anything in the appliance door. Even if the door is only left open a crack, the front of nearby furniture may become damaged over time. Only leave the cooking compartment to dry with the door open if a lot of moisture was produced whilst the oven was operating.
- Fruit juice: when baking particularly juicy fruit pies, do not pack the baking tray too generously. Fruit juice dripping from the baking tray leaves stains that cannot be removed. If possible, use the deeper universal pan.
- Extremely dirty seal: If the seal is very dirty, the appliance door will no longer close properly during operation. The fronts of adjacent units could be damaged. Always keep the seal clean.
- Appliance door as a seat, shelf or worktop: Do not sit on the appliance door, or place or hang anything on it. Do not place any cookware or accessories on the appliance door.
- Inserting accessories: depending on the appliance model, accessories can scratch the door panel when closing the appliance door. Always insert the accessories into the cooking compartment as far as they will go.
- Carrying the appliance: do not carry or hold the appliance by the door handle. The door handle cannot support the weight of the appliance and could break.

Steam

Caution!

- Baking tins: Ovenware must be heat and steam resistant. Silicone baking tins are not suitable for combined operation with steam.
- Ovenware with areas of rust: Do not use any ovenware which displays areas of rust. Even the smallest spots of rust can lead to corrosion in the cooking compartment.
- Dripping liquids: When steaming with a perforated cooking container, always insert the baking tray, the universal pan or the solid cooking container underneath. Dripping liquid is caught.
- Hot water in the water tank: Hot water can damage the pump. Only fill the water tank with cold water.
- Enamel damage: Do not start any operations when there is water on the cooking compartment floor. Before operation, wipe away the water from the cooking compartment floor.
- Descaling solution: Do not allow descaling solution to come into contact with the control panel or other sensitive surfaces. These will damage the surfaces. If this does happen, remove the descaling solution immediately with water.
- Cleaning the water tank: Do not clean the water tank in the dishwasher. Otherwise, the water tank will be damaged. Clean the water tank with a soft cloth and standard washing-up liquid.

Environmental protection

Your new appliance is particularly energy-efficient. Here you can find tips on how to save even more energy when using the appliance, and how to dispose of your appliance properly.

Saving energy

- Only preheat the appliance if this is specified in the recipe or in the tables in the operating instructions.
- Use dark, black lacquered or enamelled baking tins. They absorb heat particularly well.
- Open the appliance door as infrequently as possible during operation.
- It is best to bake several cakes one after the other. The cooking compartment is still warm. This reduces the baking time for the second cake. You can place two cake tins next to each other in the cooking compartment.
- For longer cooking times, you can switch the appliance off 10 minutes before the end of the cooking time and use the residual heat to finish cooking.

Environmentally-friendly disposal

Dispose of packaging in an environmentally-friendly manner.



This appliance is labelled in accordance with European Directive 2012/19/EU concerning used electrical and electronic appliances (waste electrical and electronic equipment - WEEE). The guideline determines the framework for the return and recycling of used appliances as applicable throughout the EU.

Getting to know your appliance

In this chapter, we will explain the displays and controls. You will also find out about the various functions of your appliance.

Note: Depending on the appliance model, individual details and colours may differ.

Control panel

In the control panel, set the appliance's different functions. The current settings are shown on the display.

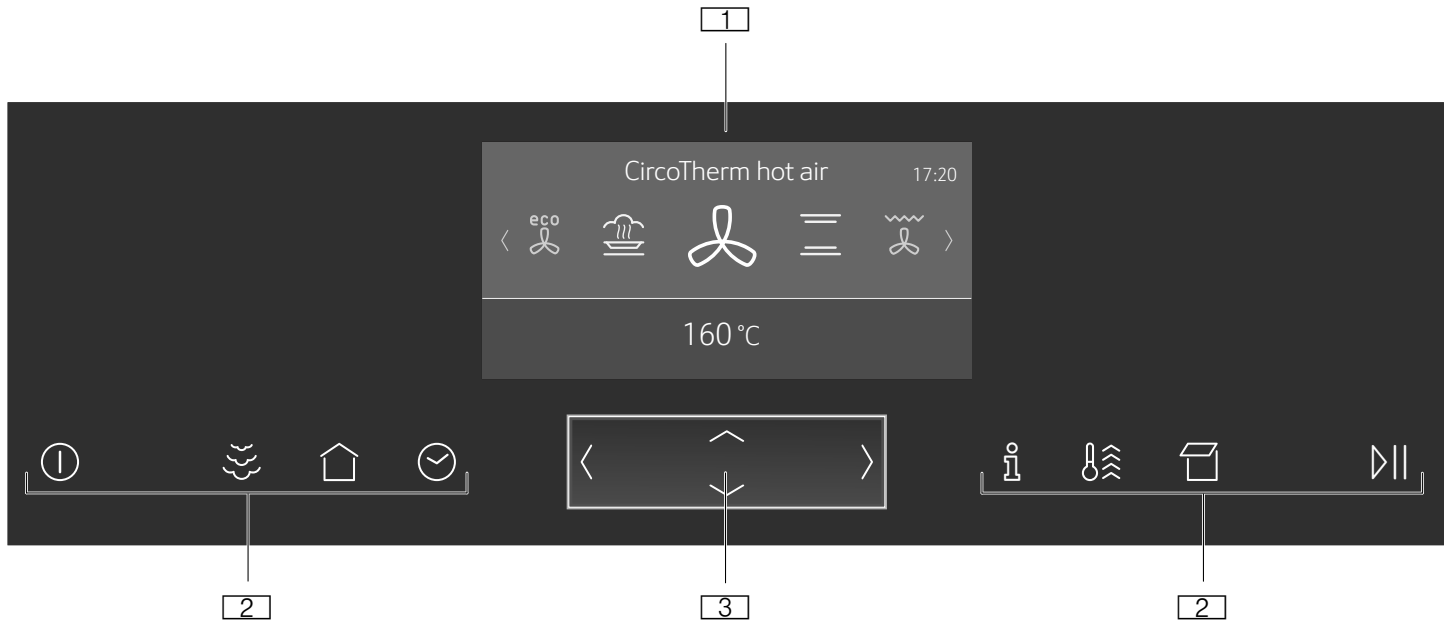





- 1** Display
- 2** Touch buttons
- 3** ShiftControl control





Controls

Use the controls to set your appliance simply and directly.

Touch buttons

There are sensors under the touch buttons. Touch on the corresponding touch button to select a function.

| Touch button | Use |
|--|--|
|  on/off | Switching the appliance on or off → "Switching the appliance on and off" on page 15 |
|  Steam-assisted cooking | Switching on steam-assisted cooking → "VarioSteam - Steam-assisted cooking" on page 17 |
|  Main menu | Selecting operating modes and settings → "Setting and starting the appliance operation" on page 15 |
|  Time-setting options | Setting the timer, cooking time, or "Ready at" start delay → "Time-setting options" on page 20 |
| Childproof lock | Activating or deactivating the childproof lock → "Childproof lock" on page 21 |

| | |
|---|--|
|  Information | Displaying further information Displaying the current temperature → "Setting and starting the appliance operation" on page 15 |
|  Rapid heating | Activating or deactivating rapid heating → "Heating up the appliance quickly" on page 16 Activating or deactivating Power-Boost → "Heating up the appliance quickly" on page 16 |
|  Open cover | Filling or emptying the water tank → "Filling the water tank" on page 18 |
|  Start/Stop | Starting or stopping the operation → "Setting and starting the appliance operation" on page 15 |

ShiftControl control



Use the ShiftControl control element to navigate through the lines on the display and select the settings. Settings that you can change are displayed more brightly.







| Button | Use |
|--------|--|
| < | Left Navigates to the left on the display |
| > | Right Navigates to the right on the display |
| ^ | Up Navigates upwards on the display |
| v | Down Navigates downwards on the display |

Note: You can also scroll through the settings values quickly by pressing and holding a button. As soon as you release the button, you stop scrolling through the values quickly.

Main menu

Touch the  touch button to access the main menu.





| Menu | Use |
|--|--|
|  | Types of heating Selecting the required type of heating and temperature for your dish → "Switching the appliance on and off" on page 15 |
|  | Baking and roasting assistant Recommended settings for baking and roasting → "Baking and roasting assistant" on page 23 |

| | |
|---|---|
|  | Steam programmes Preparing dishes with steam → "Programmes" on page 24 |
|  | MyProfile Individually adjusting the appliance settings → "Basic settings" on page 22 |
|  | Descale |
|  | Drying Drying the cooking compartment after a steam operation → "Operating the appliance" on page 15 |
|  | EasyClean Cleaning light soiling from the cooking compartment → "Cleaning function" on page 27 |
|  | Pyrolytic self-cleaning Clean the cooking compartment. → "Cleaning function" on page 27 |

Menu for the types of heating

Your appliance has different types of heating. After switching on the appliance, you are taken directly to the menu for the types of heating.

| Type of heating | Temperature | Use |
|---|--------------|--|
|  CircoTherm hot air * | 40 - 200 °C | For baking and cooking on one or more levels. The fan distributes the heat from the ring heating element in the back panel evenly around the cooking compartment. |
|  Top/bottom heating * | 50 - 275 °C | For traditional baking and roasting on one level. Especially suitable for cakes with moist toppings. Heat is emitted evenly from the top and bottom. |
|  Circo-roasting * | 50 - 250 °C | For roasting poultry, whole fish and larger pieces of meat. The grill element and the fan switch on and off alternately. The fan circulates the hot air around the food. |
|  Pizza setting | 50 - 275 °C | For preparing pizza and dishes which require a lot of heat from underneath. The bottom heating element and the ring heating element in the back panel heat up. |
|  Bread-baking * | 180 - 240 °C | For baking bread, bread rolls and baked items that require high temperatures. |
|  Grill, large area | 50 - 290 °C | For grilling flat items, such as steaks or sausages, for making toast, and for au gratin dishes. The whole area below the grill element becomes hot. |
|  Grill, small area | 50 - 290 °C | For grilling small amounts of steaks or sausages, for making toast, and for au gratin dishes. The centre area under the grill heating element becomes hot. |
|  Bottom heating | 50 - 250 °C | For cooking in a bain marie and for the final baking stage. The heat is emitted from below. |
|  Slow cooking | 70 - 120 °C | For gentle and slow cooking of seared, tender pieces of meat in ovenware without a lid. The heat is emitted evenly from the top and bottom at low temperatures. |
|  Dough proving ** | 2 levels | For leaving yeast dough and sourdough to prove and for culturing yogurt. Dough will prove more quickly than at room temperature. The surface of the dough does not dry out. |
|  * Defrost setting | 30 - 60 °C | For gently defrosting frozen food. |

| | | | |
|--|------------------------|-------------|--|
|  | Keeping warm * | 60 - 100 °C | For keeping cooked food warm. |
|  | Top/bottom heating eco | 50 - 275 °C | For energy-optimised cooking of selected dishes. Heat is emitted evenly from the top and bottom. |
|  | CircoTherm eco | 40 - 200 °C | For energy-optimised cooking of selected dishes on one level without preheating. The fan distributes the energy-optimised heat from the ring heating element in the back wall evenly around the cooking compartment. |
|  | Reheating ** | 80 - 180 °C | For gently reheating food or for crisping up pastries. |
| * Possible to use steam for this type of heating (operation only possible when the water tank is full) | | | |
| ** Type of steam heating (operation only possible when the water tank is full) | | | |

Cooking compartment functions

The functions in the cooking compartment make your appliance easier to use. This, for example, enables the cooking compartment to be well lit and a cooling fan to prevent the appliance from overheating.

Opening the appliance door

If you open the appliance door during an operation, the operation is paused. The operation continues to run when you close the door.

Note: For some types of heating, the operation continues to run even when the appliance door is open.

Interior lighting

If you open the appliance door, the interior lighting switches on. If the door remains open for longer than around 15 minutes, the lighting switches off again.

For most operating modes, the interior lighting switches on as soon as the operation is started. When the operation has finished, the lighting switches off.

Note: You can set the interior lighting not to come on during the operation in the basic settings. → "Basic settings" on page 22

Cooling fan

The cooling fan switches on and off as required. The hot air escapes above the door.

Caution!

Do not cover the ventilation slots. Otherwise, the appliance may overheat.



So that the cooking compartment cools down more quickly after the operation, the cooling fan continues to run for a certain period afterwards.

Note: You can change how long the cooling fan continues to run for in the basic settings. → "Basic settings" on page 22

Water tank

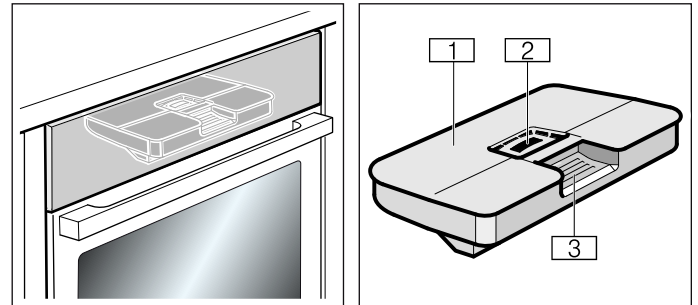
The appliance is fitted with a water tank. The water tank is behind the panel. For operations with steam, fill the water tank with water. → "Steam" on page 17



-  Tank cover
-  Filling opening
-  Handle for removing and inserting the water tank

Accessories

Your appliance is accompanied by a range of accessories. Here, you can find an overview of the accessories included and information on how to use them correctly.

Accessories included

Your appliance is equipped with the following accessories:

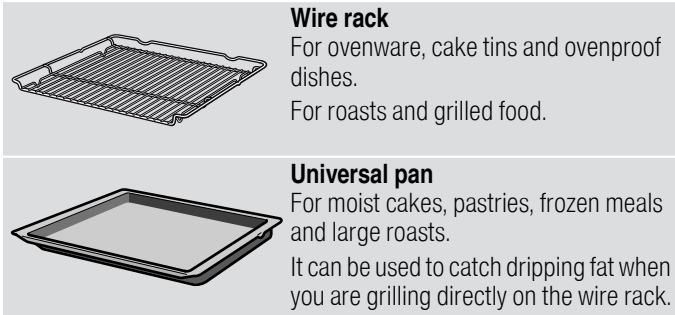

Only use genuine accessories. They are specially adapted for your appliance.

You can buy accessories from the after-sales service, from specialist retailers or online.

Note: The accessories may become deformed when they become hot. This does not affect their function. Once they cool down again, they regain their original shape.

Inserting accessories

The cooking compartment has four shelf positions. The shelf positions are counted from the bottom up.

Warning – Risk of burns!

The telescopic shelves become hot when the appliance is in use. Take special care not to get burnt when they are pulled out.

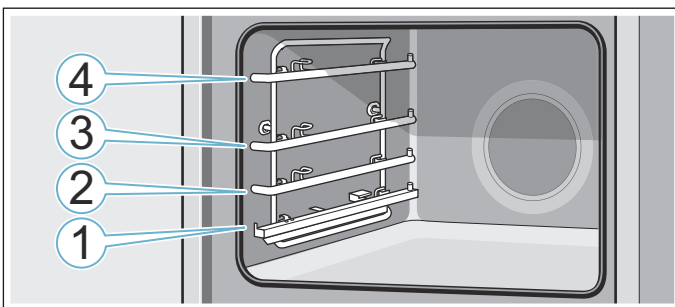

The accessories can be pulled out approximately halfway without tipping. You can use the pull-out rails to pull the accessories out further.

Ensure that the accessory is placed under the lug **a** on the pull-out rail.

Example in the picture: Universal pan

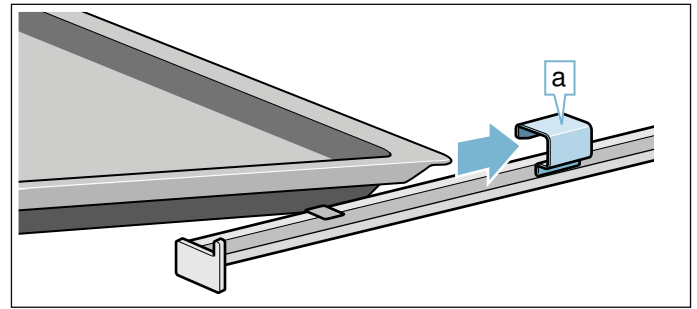

Accessories on the telescopic shelf can be pulled out as far as the notch **b** (fig. **1**). Hold the accessory on both sides in the area marked **c** and remove it (fig. **2**).

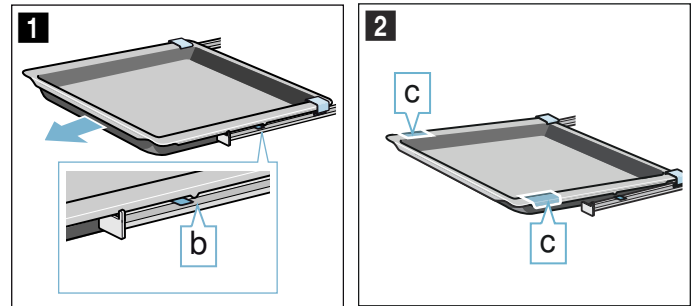

Notes

- Ensure that you always insert the accessories into the cooking compartment the right way round.
- Always insert the accessories fully into the cooking compartment so that they do not touch the appliance door.

Locking function

The accessories can be pulled out approximately halfway until they lock in place. The locking function prevents the accessories from tilting when they are pulled out. The accessories must be inserted into the cooking compartment correctly for the tilt protection to work properly.

When inserting the wire rack, ensure that the lug **a** is facing downwards.

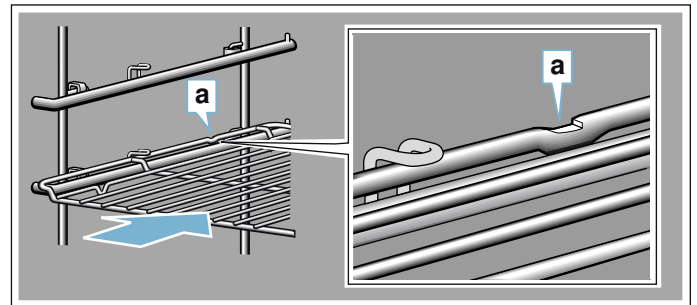

When inserting baking trays, ensure that the lug **b** is at the rear and is facing downwards. The sloping edge of the accessory **c** must be facing towards the appliance door.

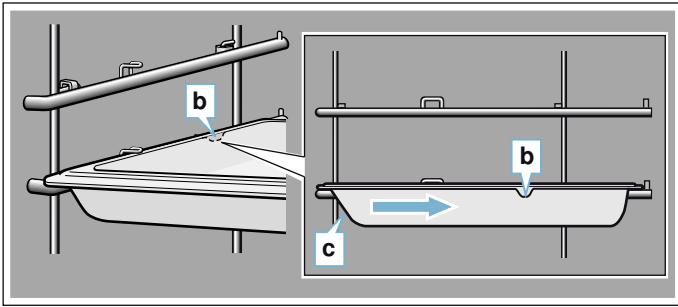

Combining accessories

You can insert the wire rack and the universal pan at the same time to catch drops of liquid.

When inserting the wire rack, ensure that both spacers **a** are at the rear edge. When the universal pan is inserted, the wire rack is on top of the upper guide rod of the shelf position.

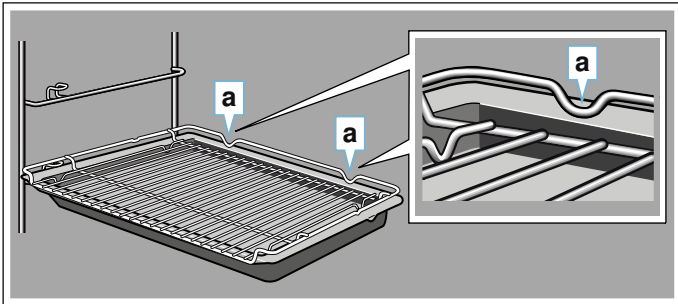

Optional accessories

You can purchase optional accessories from the after-sales service and specialist retailers, or on the Internet. You will find a comprehensive range of products for your appliance in our brochures and on the Internet.

Both availability and whether it is possible to order online differ between countries. Please see your sales documents for more details.

When purchasing, please always quote the exact order number of the optional accessory.

Note: Not all optional accessories are suitable for every appliance. When purchasing, please always quote the exact designation (E no.) of your appliance.

→ "Customer service" on page 36

| Accessories | Order number |
|--|--------------|
| Baking and roasting shelf | Z11CR10X0 |
| Baking tray, suitable for pyrolytic cleaning | Z12CB10A0 |
| Universal pan, suitable for pyrolytic cleaning | Z12CU10A0 |
| Extra-deep pan, suitable for pyrolytic cleaning | Z12CM10A0 |
| Steaming set for ovens | Z19DD10X0 |
| Profi pan, suitable for pyrolytic cleaning | Z12CN10A0 |
| Lid for the Profi pan | Z12CL10A0 |
| Pizza tray | Z1352X0 |
| Grill tray, suitable for pyrolytic cleaning | Z12CQ10A0 |
| Bread-baking stone, suitable for pyrolytic cleaning | Z1913X0 |
| Glass roasting dish, 5.1 litres | Z11GT10X0 |
| Glass pan | Z11GU10X0 |
| ComfortFlex rail (1 level), suitable for pyrolytic cleaning* | Z12TC10X0 |
| 3 x fully extendable pull-out rack, suitable for pyrolytic cleaning* | Z12TF36X0 |

* Accessory does not fit in every appliance, quote the E no. when ordering



Before using for the first time

Before you can use your new appliance, you must make some settings. You must also clean the cooking compartment and accessories.

Before using for the first time

Before using the appliance for the first time, enquire about the water hardness of your tap water from your water supplier.

So that the appliance can reliably remind you to decalcify it when required, you must correctly set your water hardness range.

Caution!

The appliance may be damaged if unsuitable liquids are used.

Do not use distilled water, highly chlorinated tap water (>40 mg/l) or other liquids.

Only use cold, fresh tap water, softened water or uncarbonated mineral water.

Notes

- If your water is very hard, we recommend that you use softened water.
- If you only use softened water, you can set the water hardness range to "softened" in this case.
- If you use mineral water, set the water hardness range to "4 very hard".
- If you use mineral water, only use uncarbonated mineral water.

| Water hardness range | Setting |
|----------------------|-------------|
| 0 | 0 softened |
| 1 (up to 1.3 mmol/l) | 1 soft |
| 2 (1.3 - 2.5 mmol/l) | 2 medium |
| 3 (2.5 - 3.8 mmol/l) | 3 hard |
| 4 (above 3.8 mmol/l) | 4 very hard |

Initial use

As soon as the appliance is connected to the power supply, the first setting "Language" appears on the display.

Setting the language

1. Use the \vee button to navigate to the bottom line.
2. Use the \langle or \rangle button to select the language.
3. Use the \wedge button to return to "Language".
4. Use the \rangle button to select the next setting.

Setting the time

1. Use the \vee button to navigate to the bottom line.
2. Use the \langle or \rangle button to select the current hour.
3. Use the \vee button to navigate to the next line.
4. Use the \langle or \rangle button to select the current minute.
5. Press the \wedge button repeatedly until "Time" appears.
6. Use the \rangle button to select the next setting.

Setting the date

1. Use the \vee button to navigate to the bottom line.
2. Use the \langle or \rangle button to select the current day.
3. Use the \vee button to navigate to the next line.
4. Use the \langle or \rangle button to select the current month.
5. Use the \vee button to navigate to the next line.
6. Use the \langle or \rangle button to select the current year.
7. Press the \wedge button repeatedly until "Date" appears.
8. Use the \rangle button to select the next setting.

Setting the water hardness

1. Use the \vee button to navigate to the bottom line.
2. Use the \langle or \rangle button to select the water hardness range.
3. Use the \wedge button to return to "Water hardness".
4. Use the \rangle button to apply the settings.
The initial use is complete.



Notes

- You can change these settings at any time in the basic settings. → "Basic settings" on page 22
- After connecting the appliance to the power or following a power cut, the settings for initial use are shown in the display.

Cleaning the cooking compartment

To remove the new-appliance smell, heat up the cooking compartment when it is empty and with the oven door closed.

1. Remove the accessories from the cooking compartment.
2. Remove leftover packaging, such as polystyrene pellets, from the cooking compartment.
3. Before heating the appliance, wipe the smooth surfaces in the cooking compartment with a soft, wet cloth.
4. Use the ① touch button to switch on the appliance.
5. Fill the water tank. → "Filling the water tank" on page 18
6. Set the heating type, temperature and steam-assisted cooking, then start the appliance operation. → "VarioSteam – Steam-assisted cooking" on page 17

| Settings | |
|--------------|--|
| Heating type | Top/bottom heating  with steam-assisted cooking  ("low" intensity) |
| Temperature | 240 °C |
| Cooking time | 1 hour |

7. Keep the kitchen ventilated while the appliance is heating up.
8. Use the ① touch button to switch off the appliance after the indicated cooking time.
9. Wait until the cooking compartment has cooled down.
10. Clean the smooth surfaces with soapy water and a dish cloth.
11. Empty the water tank and dry the cooking compartment. → "After every steam operation" on page 19

Cleaning the accessories

Clean the accessories thoroughly using soapy water and a dish cloth or soft brush.

Operating the appliance

You have already learnt about the controls and how they work. Now we will explain how to set your appliance. You will learn about what happens when you switch the appliance on and off, and how to select the operating mode.

Switching the appliance on and off

To switch the appliance on or off, touch the ① touch button.

After the appliance has switched off, the display shows whether the residual heat in the cooking compartment is high or low.

| Display | Temperature |
|--------------------|--------------------------|
| Residual heat high | above 120 °C |
| Residual heat low | between 60 °C und 120 °C |

Notes

- Certain indicators and instructions (e.g. about residual heat in the cooking compartment) remain visible on the display even when the appliance is switched off.
- After the appliance has completed an operation, you will hear the cooling fan continuing to run until the cooking compartment is cooled as much as possible.
- Switch off your appliance when you do not need to use it. If no settings are made for a long time, the appliance switches off automatically.

Setting and starting the appliance operation

Example: CircoTherm hot air  at 170 °C

1. Touch the ① touch button to switch on the appliance.
You are taken directly to the  menu for the types of heating.

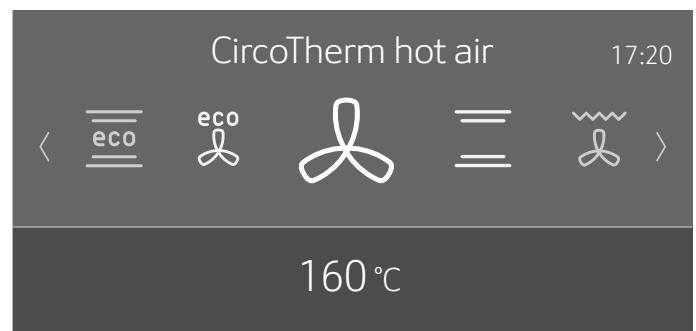

2. Use the < or > button to select the type of heating.
3. Use the  button to navigate to the next line.

- Use the < or > button to select the temperature.



Note: Depending on the operating mode, different settings are available. For each further setting, use the ~ button to navigate to the next line. Use the < or > button to select the setting.

- Touch the ▶ touch button to start the appliance operation.
The heating bar and run time appear on the display.

Note: If you would like to go directly to the ⏠ main menu after switching on the appliance, you can select the main menu under "Operation after switching on" in the basic settings chapter.

Default values

The appliance suggests a temperature or setting for each type of heating. You can accept this value or change it in the appropriate area.

Heating bar

As soon as a type of heating has started, the heating bar appears on the display. The heating bar shows the temperature increase in the cooking compartment.

Run time

When a type of heating has been started, the run time is displayed. The run time counts upwards during the operation. You can therefore check how long the operation has already been running.

Displaying the current temperature

To show the current temperature on the display, press the ⓘ touch button.

The current temperature is shown briefly only when heating up.

Further information

If the ⓘ touch button lights up, information can be displayed. Touch the ⓘ touch button to do this. The information is displayed for a few seconds.

Changing or cancelling the appliance operation

Changing the appliance operation

- Use the ▶ touch button to stop the operation.
- Use the ~ or ^ button to navigate to the line for the setting that should be changed.
- Use the < or > button to change the setting.
- Use the ▶ touch button to start the changed operation.

Notes

- The cooling fan may continue to run while an operation is interrupted.
- After a temperature change, the paused running time continues to count. After a change in the type of heating, the running time starts again from zero.

Cancelling the appliance operation

Press and hold the ▶ touch button until the appliance operation is cancelled.

Note: Operating modes such as the cleaning function cannot be cancelled.

Heating up the appliance quickly

You can use the "Rapid heat-up" and "PowerBoost" functions to reduce the preheat time. Whether the appliance is preheated with the "Rapid heat-up" function or the "PowerBoost" function depends on the type of heating that has been set. With the "PowerBoost" function, unlike with the "Rapid heat-up" function, you can place your food into the cold cooking compartment even before preheating has begun. Only cook on one level when using the "PowerBoost" function.

| Function | Type of heating | Place the food in the cooking compartment |
|---------------|--|---|
| Rapid heat-up | Top/bottom heating | after preheating |
| PowerBoost* | CircoTherm hot air Bread-baking setting | before preheating |

* Do not use more than one level for cooking







Notes

- If the ⏠ touch button is lit, the "Rapid heat-up" or "PowerBoost" function can be activated.
- To deactivate the "Rapid heat-up" or "PowerBoost" function before it has finished, touch the ⏠ touch button.

Activating the "Rapid heat-up" function

- Set top/bottom heating and the temperature.
Note: Set a temperature above 100 °C to allow the appliance to preheat quickly.
- Touch the ▶ touch button to start the appliance operation.
- Touch the ⏠ touch button to activate the "Rapid heat-up" function.
The ⏠ symbol appears on the display.
- Once the set temperature has been reached, the "Rapid heat-up" function switches itself off automatically. The ⏠ symbol disappears from the display. Place the food in the cooking compartment

Activating the "PowerBoost" function

1. Set CircoTherm hot air  or the bread baking setting  and the temperature.
Note: Set a temperature above 100 °C to allow the appliance to preheat quickly.
2. Place the food on a single level in the cooking compartment.
3. Touch the  touch button to start the appliance operation.
4. Touch the  touch button to activate the "PowerBoost" function.
The  symbol appears on the display.
Once the set temperature has been reached, the "PowerBoost" function switches itself off automatically. The  symbol disappears from the display.

Steam

With some heating modes, you can prepare food with steam assistance. In addition, the Dough proving and Reheat heating modes are available.

Warning – Risk of scalding!

When you open the appliance door, hot steam can escape. Steam may not be visible, depending on its temperature. When opening, do not stand too close to the appliance. Open the appliance door carefully. Keep children away.

Noise

Pump

You will hear a humming noise while the pump is in operation and after switching it off. This noise is caused by the pump function test. It is a normal operating noise.

Control panel

You will hear a humming or clicking noise when opening the control panel. These noises are caused by the control panel being pushed out. They are normal operating noises.

VarioSteam – Steam-assisted cooking

When you cook with steam assistance, steam is introduced into the cooking compartment at various intervals and with varying degrees of intensity. This gives you a better cooking result.

Your food

- Becomes crispy on the outside
- Develops a shiny surface
- Is succulent and tender on the inside
- Only undergoes a minimum reduction in volume

You set the combination of heating mode and steam intensity that you want. Use the information in the tables to select a suitable heating mode and steam intensity. Alternatively, select a program from the steam programs. → "Tested for you in our cooking studio" on page 36 → "Programmes" on page 24





Steam intensity

Different intensity levels are available when adding steam:







- Low
- Medium
- High

Suitable heating modes

You can switch on steam assistance for these heating modes:

- CircoTherm hot air 
- Top/bottom heating 
- Circo-roasting 
- Bread-baking 
- Keeping warm 

Starting

1. Touch the  touch button.
2. Refill the water tank.
3. Set the heating mode and temperature.
4. Touch the  touch button to switch on steam assistance.
5. Use the  button to navigate to the line with steam assistance .
6. Use the  or  button to select the steam intensity.
7. Touch the  touch button.
The appliance starts the operation.

Note: If the water tank runs dry during an operation with steam assistance, a message appears on the display prompting you to fill up the water tank. The operation continues without adding steam.

Cancelling steam addition

Touch the  touch button to cancel the addition of steam early.

Note: The operation continues without adding steam.

Cancelling appliance operation

Press and hold the  touch button until the appliance operation is cancelled.

Finishing

Touch the  touch button to switch the appliance off.











Dough proving setting

Dough will prove considerably more quickly using the "Dough proving " heating mode than at room temperature and does not dry out.

There are two levels available for the Dough proving setting. Use the information in the tables to select the appropriate level. → "Tested for you in our cooking studio" on page 36

Note: If the water tank runs dry during operation with the Dough proving setting, operation is interrupted. Fill the water tank.

Starting

1. Touch the  touch button.
2. Refill the water tank.
Note: Only switch on Dough proving once the cooking compartment has completely cooled down (to room temperature).
3. Use the  or  button to select "Dough proving .
4. Use the  button to navigate to the next line.
5. Use the  or  button to select the level.
6. Use the  button to navigate to the next line.
7. Use the  or  button to select the cooking time.
8. Touch the  touch button.
The appliance starts the operation.

As soon as the cooking time has elapsed, an audible signal sounds and the appliance ends the operation automatically. Touch the  touch button to end the audible signal.

Cancelling

Press and hold the  touch button until the appliance operation is cancelled.

Finishing











Touch the  touch button to switch the appliance off.

Reheating

With the "Reheat " heating mode, you can gently reheat food that has already been cooked or crisp up day-old baked goods. Steam is switched on automatically.

Note: If the water tank runs dry during operation with the Reheat setting, operation is interrupted. Fill the water tank.

Starting

1. Touch the  touch button.
2. Refill the water tank.
3. Use the  or  button to select "Reheat .
4. Use the  button to navigate to the next line.
5. Use the  or  button to select the temperature.
6. Use the  button to navigate to the next line.
7. Use the  or  button to select the cooking time.
8. Touch the  touch button.
The appliance starts the operation.

As soon as the cooking time has elapsed, an audible signal sounds and the appliance ends the operation automatically. Touch the  touch button to end the audible signal.

Cancelling

Press and hold the  touch button until the appliance operation is cancelled.

Finishing

Touch the  touch button to switch the appliance off.

Filling the water tank

The water tank is located behind the control panel. Before starting an operation with steam, open the control panel and fill the water tank with water.

Make sure that you have set the water hardness range correctly. → "Basic settings" on page 22

Warning – Risk of injury and risk of fire!

Only fill the water tank with water or with the descaling solution that is recommended by us. Do not pour any flammable liquids (e.g. alcoholic drinks) into the water tank. Due to hot surfaces, vapours from flammable liquids may catch fire in the cooking compartment (explosion). The appliance door may spring open. Hot steam and jets of flame may escape.

Warning – Risk of burns!

The water tank may heat up while the appliance is in operation. Wait until the water tank has cooled down after the previous appliance operation. Remove the water tank from the water tank recess.

Caution!

The appliance may become damaged due to the use of unsuitable liquids.

Do not use distilled water, highly chlorinated tap water (> 40 mg/l) or other liquids.

Only use cold, fresh tap water, softened water or uncarbonated mineral water.

Notes

- If your water is very hard, we recommend that you use softened water.
- If you use only softened water, you can set your appliance to the "softened" water hardness range.
- If you use mineral water, set the water hardness range to "4 very hard".
- If you use mineral water, you must only use non-carbonated mineral water.

1. Touch the  touch button. The control panel is automatically pushed forwards.
2. Pull the control panel forwards with both hands and then push it upwards until it locks into place (Fig. 1).
3. Lift the water tank and remove it from the water tank recess (Fig. 2).

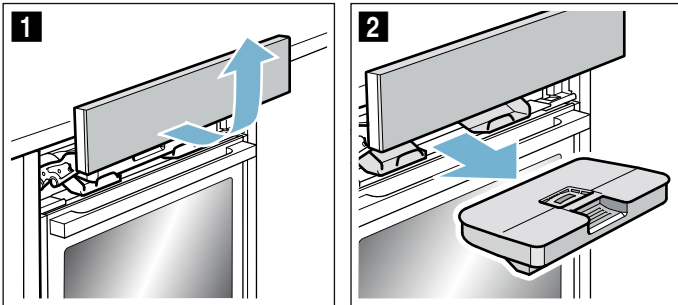

4. Press down on the lid along the seal to prevent water from leaking out of the water tank.
5. Fill the water tank with cold water up to the "max." mark (Fig. 3).

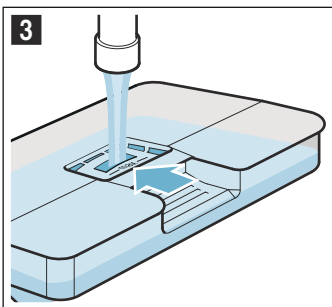

6. Insert the filled water tank (Fig. 4). Ensure that the water tank locks into place behind both holders **a** (Fig. 5).

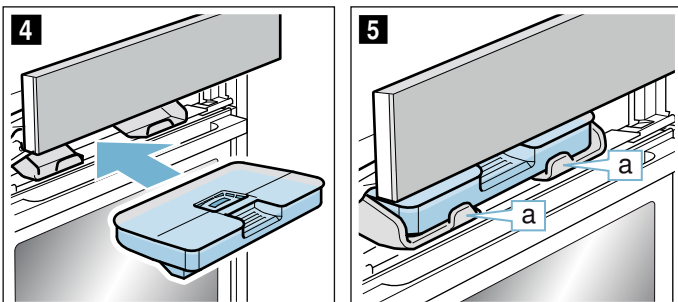

7. Slowly push the control panel downwards and then towards the rear until it is closed completely. The water tank has been filled. You can start operations with steam.

Refilling the water tank

If the water tank runs dry during a steam operation, a message appears on the display prompting you to fill up the water tank.

Notes

- Steam-assisted operations continue without adding steam.
- If the water tank runs dry during operation with the Dough proving or Reheat settings, operation is interrupted. Fill the water tank.

1. Open the control panel.
2. Remove and refill the water tank.
3. Insert the filled water tank and close the control panel.

After every steam operation**⚠ Warning – Risk of scalding!**

When you open the appliance door, hot steam can escape. Steam may not be visible, depending on its temperature. When opening, do not stand too close to the appliance. Open the appliance door carefully. Keep children away.

⚠ Warning – Risk of burns!

The appliance becomes hot during operation. Allow the appliance to cool down before cleaning.

Caution!

Enamel damage: Do not start any operations when there is water on the cooking compartment floor. Before operation, wipe away the water from the cooking compartment floor.

The remaining water is pumped back into the water tank after every operation with steam. Then empty and dry the water tank. Moisture remains in the cooking compartment. To dry the cooking compartment, you can either use the "Drying ☺" operating mode or dry the cooking compartment by hand.

Notes

- Once the appliance has been switched off, the  touch button remains lit for a little longer to remind you to empty the water tank.
- Remove limescale marks with a cloth soaked in vinegar, then wipe with clean water and dry with a soft cloth.

Emptying the water tank

Caution!

- Do not dry the water tank in the hot cooking compartment. This will damage the water tank.
- Do not clean the water tank in the dishwasher. This will damage the water tank.









1. Open the control panel.
2. Remove water tank.
3. Carefully remove the lid of the water tank.
4. Empty the water tank, clean it with detergent and then rinse it thoroughly with clean water.
5. Dry all parts with a soft cloth.
6. Rub the seal on the lid until dry.
7. Leave to dry with the lid open.
8. Place the lid on the water tank and push it down.
9. Insert the water tank and close the control panel.

Starting drying

During drying, the cooking compartment is heated up so that the moisture in the cooking compartment evaporates. Then open the appliance door so that the steam escapes.

Caution!

Enamel damage: Do not start any operations when there is water on the cooking compartment floor. Before operation, wipe away the water from the cooking compartment floor.



1. Leave the appliance to cool down.
2. Remove the worst dirt from the cooking compartment immediately and wipe away moisture from the cooking compartment floor.
3. If necessary, touch the  touch button to switch the appliance on.
4. Touch the  touch button to display the operating modes.
5. Use the  or  button to select "Drying ".
6. Use the  button to navigate to the next line. The duration is displayed. It cannot be changed.
7. Use the  button to navigate to the next line.
8. Touch the  touch button.
The drying function is started and is ended automatically after 10 minutes.
9. Open the appliance door and leave it open for 1 to 2 minutes so that the moisture in the cooking compartment can escape.

Drying the cooking compartment by hand

1. Leave the appliance to cool down.
2. Remove any dirt from the cooking compartment.
3. Dry the cooking compartment with a soft cloth.
4. Leave the appliance door open for one hour so that the cooking compartment dries completely.

Time-setting options

Your appliance has different time-setting options.



| Time-setting option | Use |
|--|--|
|  Timer | The timer functions like an egg timer. The appliance does not switch on and off automatically. |
|  Cooking time | Once the set cooking time has elapsed, the appliance switches off automatically. |
|  Ready at | The appliance switches on automatically, and once the set cooking time has elapsed and the end time has passed, it switches off automatically. |

Note: If you have set a time-setting option, the time interval increases if you set a higher value. Example: You can set a cooking time of up to one hour in one-minute increments; for cooking times over one hour, you can set a cooking time in five-minute increments.

Showing and hiding the time-setting options







To show or hide the time-setting options, touch the  touch button.

Note: After a particular length of time, the time-setting options that are shown are automatically hidden. If you have already set a cooking time, it will be applied.

| | |
|--|-----------------|
|  Timer | --:-- min s > |
|  Duration | --:-- h min |
|  Ready at | 17:20 |

Setting the timer







The timer can be set when the appliance is switched on or off.

1. Touch the  touch button.
The time-setting options are shown on the display.
2. Select the cooking time using the  button.
Note: When the appliance is switched on, use the  button to navigate to the Timer  line and then select the cooking time using the  button.
3. Touch the  touch button to start the timer.
The  symbol appears on the display. The timer counts down.

Note: As soon as the set time has elapsed, a signal sounds. To cancel the signal tone, touch the  touch button.

Setting the cooking time

Once the set cooking time has elapsed, the appliance switches off automatically. The function can only be used in combination with a type of heating.

1. Touch the  touch button.
2. Set the type of heating and temperature.
3. Touch the  touch button.
The time-setting options are shown in the display.
4. Use the  or  button to set the cooking time.
 - Default value for the  button = 10 minutes
 - Default value for the  button = 30 minutes
5. Touch the  touch button to start the set cooking time.







As soon as the cooking time has elapsed, an audible signal sounds and the appliance ends the operation automatically. Touch the  touch button to end the audible signal.

Start delay – "Ready at"

The appliance switches on automatically and switches off at the preset end time. To do this, set the cooking time and determine the end time for the operation.





The start delay can only be used in combination with a type of heating.

Notes

- Ensure that food is not left in the cooking compartment for too long as it may spoil.
 - It is not possible to start every type of heating with a start delay.
1. Slide food into the cooking compartment on a suitable accessory and close the appliance door.
 2. Touch the  touch button.
 3. Set the type of heating and temperature.
 4. Touch the  touch button.
The time-setting options are shown on the display.
 5. Select the cooking time using the  button.
 6. Use the  button to navigate to the "→ Ready at" line.
 7. Select the end time using the  button.
 8. Touch the  touch button.
The appliance waits until the appropriate time to start the operation.

As soon as the end time has passed, a signal sounds and the appliance stops the operation automatically. To cancel the signal tone, touch the  touch button.

Checking, changing or deleting settings



1. Touch the  touch button.
The time-setting options are shown on the display.
2. Use the  or  button to navigate through the lines.
3. If necessary, change the setting using the  or  button. Set "00:00" to delete a time function.
The setting is applied automatically.

Childproof lock

Your appliance is equipped with a childproof lock so that children cannot switch it on accidentally or change any settings.

Your appliance has two different locks.













| Lock | Activate/deactivate |
|---------------------------|--|
| Automatic childproof lock | Via the MyProfile menu → "Basic settings" on page 22 |
| One-time childproof lock | Via the  touch button |

Note: As soon as you activate the childproof lock, the control panel is locked. The  and  touch buttons are not included. You can deactivate the childproof lock at any time.



Automatic childproof lock

The control panel is locked so that the appliance cannot be switched on. To switch it on, the automatic childproof lock must be interrupted. After the appliance operation, the control panel is locked automatically.













Activating

1. Touch the  touch button.
2. Touch the  touch button.
3. Use the  or  button to select "MyProfile".
4. Use the  button to navigate to the next line.
5. Use the  or  button to select "Automatic childproof lock".
6. Use the  button to navigate to the bottom line.
7. Use the  button to select "Activated".
8. Touch the  touch button.
9. Use the  button to navigate to the next line to save the setting.
The "Automatic childproof lock" is activated. The  symbol appears on the display after switching off the appliance.

Cancelling

1. Press and hold the  touch button until "Childproof lock deactivated" appears on the display.
2. Touch the  touch button.
3. Switch on the required appliance operation.

Deactivating

1. Press and hold the  touch button until "Childproof lock deactivated" appears on the display.
2. Touch the  touch button.
3. Touch the  touch button.
4. Use the  or  button to select "MyProfile".
5. Use the  button to navigate to the next line.
6. Use the  or  button to select "Automatic childproof lock".
7. Use the  button to navigate to the bottom line.
8. Use the  button to select "Deactivated".
9. Touch the  touch button.
10. Use the  button to navigate to the next line to save the setting.
The "Automatic childproof lock" is deactivated.
11. Touch the  touch button.

One-time childproof lock

The control panel is locked so that the appliance cannot be switched on. To switch it on, the one-time childproof lock must be deactivated. After the appliance is switched off, the control panel is no longer locked.

Activating and deactivating

1. Press and hold the ⊖ touch button until "Childproof lock activated" appears on the display.
The childproof lock is activated.
2. Press and hold the ⊖ touch button until "Childproof lock deactivated" appears on the display.
The childproof lock is deactivated.

Basic settings

There are various settings available to you in order to help use your appliance effectively and simply. If necessary, you can change these settings in MyProfile .

Changing MyProfile

1. Touch the ① touch button.
2. Touch the ⬆ touch button.
3. Use the < or > button to select "MyProfile .
4. Use the ∨ button to navigate to the next line.
5. Use the < or > button to select the setting.
6. Use the ∨ button to navigate to the selection.
7. Use the < or > button to select the setting.
8. Touch the ⬆ touch button.
9. To save the setting, use the ∨ button to select "Save".
To discard the setting, use the ^ button to select "Discard".

List of basic settings















| Setting | Selection |
|---------------------------|---|
| Language | Select language |
| Time of day | Sets the current time |
| Date | Sets the current date |
| Water hardness | 0 (softened) 1 (soft) 2 (medium) 3 (hard) 4 (very hard) |
| Favourites | Set the heating types that should be shown in the heating types menu |
| Audible signal | Short duration Medium duration Long duration |
| Button tone | Switched off (Exception: The button tone for the ① touch button remains switched on) Switched on |
| Display brightness | Adjustable across 5 levels |
| Clock display | Digital Off |
| Lighting | On during operation Off during operation |
| Childproof lock* | Only key lock Door lock and key lock |
| Automatic childproof lock | Deactivated Activated |

| | |
|--|--|
| Action after switching on | Main menu |
| | Heating types |
| | Baking and roasting assistant |
| | Steam programmes |
| Night-time dimming | Switched off |
| | Switched on (display dimmed between 10 p.m. and 5.59 a.m.) |
| Brand name logo | Display |
| | Do not display |
| Fan run-on time | Recommended |
| | Minimum |
| Pull-out system* | Not retrofitted (rack or single pull-out system) |
| | Retrofitted (double or triple pull-out system) |
| Factory settings | Restore |
| *) Depending on the appliance model, this basic setting cannot be selected | |



Setting favourites

You can set which heating types are shown in the heating types menu.

Note: The "CircoTherm hot air", "Circo-roasting" and "Grill, large area" heating types are always shown in the heating types menu. They cannot be deactivated.

1. Touch the  touch button.
2. Touch the  touch button.
3. Use the  or  button to select "MyProfile .
4. Use the  button to navigate to the next line.
5. Use the  or  button to select "Favourites".
6. Use the  button to select "Setting favourites".
7. Use the  or  button to select the heating type.
8. Use the  button to navigate to the next line.
9. Use the  or  button to select "Activated" or "Deactivated".

Note: If you have selected "Activated", the heating type is shown in the heating types menu. If you have selected "Deactivated", the heating type is not shown in the heating types menu.

10. Touch the  touch button.
11. To save the setting, use the  button to select "Save".
To discard the setting, use the  button to select "Discard".

Baking and roasting assistant

The baking and roasting assistant helps you to prepare meals with ease. The appliance applies the most suitable settings.

















To achieve good results, the cooking compartment must not be too hot for the type of food you have selected. If it is, a message will appear on the display. Allow the cooking compartment to cool down and start again.

Information on the settings

- The cooking result depends on the quality of the food and the type of cookware. For an optimal cooking result, use food that is in good condition and chilled meat only.
- The baking and roasting assistant helps you to prepare classic cakes, bread and roasts. The appliance selects the optimal type of heating for you. It suggests a suitable temperature and cooking time, which you can change if you wish.
- Information is provided, e.g. on cookware, shelf position or the addition of liquid when cooking meat. Some food requires turning or stirring, etc. during cooking. This is shown in the display shortly after operation starts. An audible signal will remind you at the right time.
- Information on the right kind of cookware to use and tips and tricks for preparation can be found at the end of the instruction manual.

Selecting and setting food

You will be guided through the entire setting process for your chosen food.

1. Touch the  touch button to switch on the appliance.
2. Touch the  touch button.
3. Use the  or  button to select the "Baking and roasting assistant".
4. Use the  button to navigate to the next line.
5. Use the  or  button to select the required category.
6. Use the  button to navigate to the next line.
7. Use the  or  button to select the required meal.
8. Use the  button to navigate to the next line. The recommended settings appear on the display.
9. You can change the recommended settings if you wish. Touch the  button to do this. Use the  or  button to navigate to the required setting. Use the  or  button to change the setting.
10. Touch the  touch button to start the appliance operation.





As soon as the cooking time has elapsed, an audible signal sounds and the appliance ends the operation automatically. Touch the  touch button to end the audible signal.

Some recommended settings offer you the opportunity to continue cooking your dish.

When you are happy with the cooking result, use the  button to select "End".

If you are not happy with the cooking result, you can continue cooking your dish.

Continue cooking

1. Use the  button to select "Continue cooking".
2. If necessary, use the  or  button to change the recommended setting.
3. Touch the  touch button to start "Continue cooking".

Cancelling

Press and hold the  touch button until the appliance operation is cancelled.

Switching off the appliance

Touch the  touch button to switch off the appliance.

Programmes

You can prepare food very easily using the various programmes. You select a programme and enter the weight of your food. The program then applies the most suitable settings.

To achieve good results, the cooking compartment must not be too hot for the type of food you have selected. If it is, a message will appear on the display. Allow the cooking compartment to cool down and start again.

Information about the programmes

- The cooking result depends on the quality of the food and the type of cookware used. For best results, only use high-quality food and refrigerated meat. For frozen products, only use food directly from the freezer.
- For some dishes, you will be required to enter the weight. The appliance will then apply the time and temperature settings for you. It is not possible to set weights outside the intended weight range.
- For roasting programmes, for which the appliance applies the temperature selection, temperatures can be as high as 300 °C. Therefore ensure that you are using heat-resistant cookware.
- Information about cookware, shelf position or adding liquid for meat is provided for you. For some dishes, the food needs to be turned or stirred during cooking. This is shown briefly on the display after the start. A signal reminds you to do this at the right time.
- Information about suitable cookware and preparation tips and tricks can be found at the end of the instruction manual.

Steam

For the steam programme, the appliance provides you with programmes you can use to prepare your meals easily and professionally. The appliance indicates when the water tank should be filled.















Information about the steam functions can be found in the relevant sections. → "Steam" on page 17

Warning – Risk of scalding!

When you open the appliance door, hot steam can escape. Steam may not be visible, depending on its temperature. When opening, do not stand too close to the appliance. Open the appliance door carefully. Keep children away.

Selecting and setting the programme

You will be guided through the entire setting process for your chosen food.

1. Touch the  touch button to switch on the appliance.
2. Touch the  touch button.
3. Use the  or  button to select "Steam programmes".
4. Use the  button to navigate to the next line.
5. Use the  or  button to select the required meal category.
6. Use the  button to navigate to the next line.
7. Use the  or  button to select the required steam programme.
8. Use the  button to navigate to the next line.
9. Use the  or  button to set the weight.
10. Use the  button to navigate to the next line. Information on the slide-in level and the cookware to be used appears.
11. Touch the  touch button to start the appliance operation.
The estimated cooking time is shown.

Note: For some programmes, the displayed temperature may change during the first few minutes, as the heating-up time depends on the temperature of the food and the water, amongst other things.





As soon as the cooking time has elapsed, an audible signal sounds and the appliance ends the operation automatically. Touch the  touch button to end the audible signal.

Some programmes offer you the opportunity to continue cooking your dish.

When you are happy with the cooking result, use the  button to select "End".

If you are not happy with the cooking result, you can continue cooking your dish.

Continue cooking

1. Use the  button to select "Continue cooking".
2. If necessary, use the  or  button to change the recommended setting.
3. Touch the  touch button to start "Continue cooking".

Cancelling

Press and hold the  touch button until the appliance operation is cancelled.

Switching off the appliance

Touch the  touch button to switch off the appliance.



Sabbath mode











You can set a time of up to 74 hours using Sabbath mode. The food in the cooking compartment remains warm, without you having to switch the appliance on or off.

Starting Sabbath mode

Before you can use Sabbath mode, you must activate it under "Favourites" in the basic settings.

Once the Sabbath mode has been activated, you can select it under the menu for the types of heating.

The appliance heats up with top/bottom heating. The temperature can be set between 85 °C and 140 °C.

1. Touch the  touch button.
2. Use the  or  button to select "Sabbath mode".
3. Use the  button to navigate to the next line.
4. Use the  or  button to select the temperature.
5. Use the  button to navigate to the next line.
6. Use the  or  button to select the cooking time.
7. Touch the  touch button.
The appliance starts the operation.

Notes

- Once Sabbath mode has started, you can no longer change any settings or cancel the operation using the  touch button.
- The operation is not interrupted if you open the appliance door.

Once the Sabbath mode duration has elapsed, a signal sounds. The appliance stops heating. Use the  touch button to switch off the appliance.

Cancelling Sabbath mode

Touch the  touch button to cancel Sabbath mode.

Cleaning agent

With good care and cleaning, your appliance will retain its appearance and remain fully functioning for a long time to come. We will explain here how you should correctly care for and clean your appliance.

Suitable cleaning agents

To ensure that the different surfaces are not damaged by using the wrong cleaning agent, observe the information in the table. Depending on the appliance model, not all of the areas listed may be on/in your appliance.

Caution!

Risk of surface damage

Do not use:

- Harsh or abrasive cleaning agents,
- Cleaning agents with a high alcohol content,
- Hard scouring pads or cleaning sponges,
- High-pressure cleaners or steam cleaners,
- Special cleaners for cleaning the appliance while it is hot.

Wash new sponge cloths thoroughly before use.

Tip: Highly recommended cleaning and care products can be purchased through the after-sales service. Observe the respective manufacturer's instructions.

Warning – Risk of burns!

The appliance becomes very hot. Never touch the interior surfaces of the cooking compartment or the heating elements. Always allow the appliance to cool down. Keep children at a safe distance.

| Area | Cleaning |
|---------------------------|--|
| Appliance exterior | |
| Stainless steel front | Hot soapy water: Clean with a dish cloth and then dry with a soft cloth. Remove flecks of limescale, grease, starch and albumin (e.g. egg white) immediately. Corrosion can form under such flecks. Special stainless steel cleaning products suitable for hot surfaces are available from our after-sales service or from specialist retailers. Apply a very thin layer of the cleaning product with a soft cloth. |
| Plastic | Hot soapy water: Clean with a dish cloth and then dry with a soft cloth. Do not use glass cleaner or a glass scraper. |
| Painted surfaces | Hot soapy water: Clean with a dish cloth and then dry with a soft cloth. |
| Control panel | Hot soapy water: Clean with a dish cloth and then dry with a soft cloth. Do not use glass cleaner or a glass scraper. |

| | |
|---------------------------------------|---|
| Door panels | Hot soapy water: Clean with a dish cloth and then dry with a soft cloth. Do not use a glass scraper or a stainless steel scouring pad. |
| Door handle | Hot soapy water: Clean with a dish cloth and then dry with a soft cloth. If descaler comes into contact with the door handle, wipe it off immediately. Otherwise, any stains will not be able to be removed. |
| Appliance exterior | |
| Enamel surfaces | Hot soapy water or a vinegar solution: Clean with a dish cloth and then dry with a soft cloth. Soften baked-on food residues with a damp cloth and soapy water. If there are heavy deposits of dirt, use a stainless steel scouring pad or oven cleaner. Leave the cooking compartment open to dry after cleaning. It is best to use the cleaning function. → "Cleaning function" on page 27 |
| Glass cover for the interior lighting | Hot soapy water: Clean with a dish cloth and then dry with a soft cloth. If the cooking compartment is heavily soiled, use oven cleaner. |
| Stainless steel door cover | Stainless steel cleaner: Observe the manufacturer's instructions. Do not use stainless steel care products. Remove the door cover for cleaning. |
| Rails | Hot soapy water: Soak and clean with a dish cloth or brush. |
| Pull-out system | Hot soapy water: Clean with a dish cloth or a brush. Do not remove the lubricant while the pull-out rails are pulled out – it is best to clean them when they are pushed in. Do not clean in the dishwasher. |
| Accessories | Hot soapy water: Soak and clean with a dish cloth or brush. If there are heavy deposits of dirt, use a stainless steel scouring pad. |
| Water tank | Hot soapy water: Clean with a dish cloth and rinse thoroughly to remove residual detergent. Then dry with a soft cloth. Leave the water tank to dry with the lid open. Rub the seal on the lid until dry. Do not clean in the dishwasher. |

Notes

- Slight differences in colour on the front of the appliance are caused by the use of different materials, such as glass, plastic and metal.
- Shadows on the door panels, which look like streaks, are caused by reflections made by the interior lighting.
- Enamel is baked on at very high temperatures. This can cause some slight colour variation. This is normal and does not affect operation. The edges of thin trays cannot be completely enamelled. As a result, these edges can be rough. This does not impair the anti-corrosion protection.

Keeping the appliance clean

Always keep the appliance clean and remove dirt immediately so that stubborn deposits of dirt do not build up.

Tips

- Clean the cooking compartment after each use. This will ensure that dirt cannot be baked on.
- Always remove flecks of limescale, grease, starch and albumin (e.g. egg white) immediately.
- Use the universal pan for baking very moist cakes.
- Use suitable ovenware for roasting, e.g. a roasting dish.
- Where possible, use Circotherm hot air. This type of heating creates less dirt.



Cleaning function

Your appliance is equipped with a self-cleaning function, EasyClean and a descaling function. You can use the self-cleaning function to clean the cooking compartment. Use the EasyClean cleaning aid for intermediate cleaning of the cooking compartment. Dirt is softened beforehand using EasyClean. It can then be removed more easily. You can use the descaling function to remove limescale from the evaporator.

Self-cleaning

You can use the "Self-cleaning" operating mode to clean the cooking compartment effortlessly. The cooking compartment is heated up to a very high temperature. Residues from roasting, grilling and baking will burn.

You can choose from three cleaning settings.

| Setting | Cleaning level | Duration |
|---------|----------------|----------------------------|
| 1 | Light | Approx. 1 hour, 15 minutes |
| 2 | Medium | Approx. 1 hour, 30 minutes |
| 3 | Intensive | Approx. 2 hours |

The dirtier the cooking compartment and the longer the dirt has been there, the higher the cleaning setting should be. It is sufficient to clean the cooking compartment every two to three months. If required, you can clean the oven more frequently. A cleaning cycle requires only approx. 2.5 – 4.7 kilowatt hours.

Note: For your safety, the cooking compartment door locks automatically. It cannot be opened again until the  symbol for the locking mechanism goes out in the status bar. The interior lighting remains off during cleaning.

 Warning – Risk of burns!

- The cooking compartment becomes extremely hot during the cleaning function. Never open the appliance door or move the locking latch by hand. Allow the appliance to cool down. Keep children away from the appliance.
-  The appliance will become very hot on the outside during the cleaning function. Never touch the appliance door. Allow the appliance to cool down. Keep children away from the appliance.

Prior to initiating the cleaning function**Caution!**

Before cleaning is started, remove the water tank from the appliance. → "Steam" on page 17

When using the cleaning function, you can clean an accessory at the same time, e.g. the universal pan or the baking tray. Before cleaning is started, remove the worst dirt. Slide the accessory in at level 2.

Clean the inside of the appliance door and along the surface edges of the cooking compartment in the area around the seal. Do not scrub the seal.

Note: When using the cleaning function, you can clean the enamel accessory provided at the same time. You cannot clean any of the wire racks when using the cleaning function. The wire racks are not suitable for cleaning using the cleaning function; this will discolour them. Further accessories suitable for cleaning using the cleaning function are listed in the table for special accessories. → "Accessories" on page 12









⚠ Warning – Risk of fire!

- Loose food residues, grease and meat juices may catch fire during the cleaning function. Before starting the cleaning function, remove coarse dirt from the cooking compartment and from the accessories.
- The appliance will become very hot on the outside during the cleaning function. Never hang combustible objects, e.g. tea towels, on the door handle. Do not place anything against the front of the appliance. Keep children away from the appliance.



⚠ Warning – Risk of serious damage to health!

The appliance will become very hot during the cleaning function. The non-stick coating on baking trays and tins is destroyed and noxious gases are released. Never clean non-stick baking trays and baking tins using the cleaning function. Only clean enamelled accessories using the cleaning function.

Starting

1. Touch the  touch button.
2. Touch the  touch button.
3. Use the  or  button to select "Self-cleaning ".
4. Use the  button to navigate to the next line.
5. Use the  or  button to select the cleaning setting.

Note: Once it has started, the cleaning setting can no longer be changed.



6. Use the  button to navigate to the next line.
7. Touch the  touch button.

The appliance starts self-cleaning.

During self-cleaning, the appliance door is locked automatically. The  symbol appears on the display.

Note: If you would like to start self-cleaning later, set an end time.

Cancelling

Touch the  touch button to cancel. The appliance door cannot be opened until the  symbol goes out.

Finishing

As soon as self-cleaning has run through, a signal sounds. The appliance door cannot be opened until the  symbol goes out.

Once the cleaning function has ended

Once the cooking compartment has cooled down, wipe off the ash that has been left behind in the cooking compartment, in the accessories on the racks and around the appliance door with a damp cloth.

After cleaning, the rails may retain some discolouration. This does not affect their function. Wipe the rails with a damp cloth. Then slide the rails in and out several times.

EasyClean



The EasyClean cleaning aid makes it easier to clean the cooking compartment. Dirt is softened beforehand by vaporizing soapy water. It can then be removed more easily.







⚠ Warning – Risk of scalding!

Water in a hot cooking compartment may create hot steam. Never pour water into the hot cooking compartment.

Starting

Notes

- The "EasyClean " cleaning aid can only be started once the cooking compartment is cold (room temperature) and the appliance door is closed.
- Do not open the appliance door during operation. Doing this will interrupt the "EasyClean " cleaning aid.

1. Remove the accessories from the cooking compartment.
2. Mix 0.4 litres of water (not distilled water) with a drop of washing-up liquid and pour into the middle of the cooking compartment floor.
3. Touch the  touch button.
4. Touch the  touch button.
5. Use the  or  button to select "EasyClean ".
6. Use the  button to navigate to the next line.
7. Touch the  touch button.
The appliance starts EasyClean. The remaining time appears on the display.

Finishing

As soon as the cleaning aid has finished, an audible signal sounds and the appliance ends the operation automatically.

As soon as you open the appliance door, the interior lighting is switched on so that you can finish cleaning the cooking compartment more easily. The remaining water in the cooking compartment must be removed promptly. Do not leave the remaining water in the cooking compartment for a long time (e.g. overnight). The appliance must not be operated when the cooking compartment is still wet or damp.

Final cleaning

1. Open the appliance door and remove the remaining water with an absorbent sponge cloth.
2. Clean the smooth surfaces in the cooking compartment with a dish cloth or a soft brush. Stubborn residues can be removed using a stainless steel scouring pad.
3. Remove limescale with a cloth soaked in vinegar. Then wipe with clean water and rub dry with a soft cloth (including under the door seal).

4. Use the  touch button to switch off the appliance.
5. Leave the appliance door ajar in the locking position (approx. 30°) for approx. 1 hour to allow the enamel surfaces in the cooking compartment to dry. Alternatively, you can also run the rapid drying function for the cooking compartment.

Running the rapid drying function for the cooking compartment

1. After the cleaning aid process has finished, leave the appliance door ajar in the locking position (approx. 30°).
2. Touch the  touch button.
3. Start CircoTherm hot air at 50 °C.
4. After 5 minutes, switch off the appliance and close the appliance door.

Removing heavy deposits of dirt

You have several options for removing particularly stubborn deposits of dirt.

- Leave the soapy water to work for some time before starting the cleaning aid.
- Rub soapy water onto the dirt on the smooth surfaces before starting the cleaning aid.
- Repeat the cleaning aid once the cooking compartment has cooled down.

Descaling

The appliance must be descaled regularly in order for it to continue operating correctly.

There are several steps in the descaling programme. For hygiene reasons, the descaling programme must be run through completely so that the appliance can be ready for operation again. In total, the descaling programme runs for approx. 70-90 minutes.

- Descal (approx. 55-70 minutes), then empty and refill the water tank
- First rinsing cycle (approx. 6-9 minutes), then empty and refill the water tank
- Second rinsing cycle (approx. 6-9 minutes), then empty and dry the water tank

If the descaling process is interrupted (for example, due to a power failure or because the appliance has been switched off), you are prompted to rinse the appliance twice after it is switched back on. The appliance cannot be used until the second rinsing cycle has come to an end.









The frequency with which the appliance must be descaled depends on the hardness of the water used. When only five more steam-assisted operations are possible, or fewer, the appliance reminds you to descale it with a message on the display. The number of remaining operations is displayed after the appliance is switched on. You can therefore prepare for the descaling in good time.

Start

Caution!

- Damage to the appliance: Use only liquid descalers that are recommended by us for the descaling programme. The time the product needs to work during descaling depends on the type of descaler used. Other descalers may damage the appliance. Descaler order no. 311 680
- Descaling solution: Do not allow any descaling solution or descaler to come into contact with the control panel or other delicate surfaces. This will damage the surfaces. If this does happen, remove the descaling solution immediately with water.

If you have used a steam-assisted operation immediately before descaling, you must first switch the appliance off so that the residual water is pumped out of the evaporator system.

1. Mix 400 ml water with 200 ml liquid descaler to make a descaling solution.
2. Touch the  touch button.
3. Remove the water tank and fill with descaling solution.
4. Fully insert the water tank filled with the descaling solution.
5. Close the control panel.
6. Touch the  touch button.
7. Use the  or  button to select "Descal ".
8. Use the  button to navigate to the next line. The duration of the descaling programme is displayed. It cannot be changed.
9. Use the  button to navigate to the next line.
10. Touch the  touch button. The appliance is descaled. The time counts down on the display. As soon as the descaling programme has finished, an audible signal sounds.

First wash cycle

1. Open the control panel.
2. Remove the water tank, rinse thoroughly, fill with water and reinsert.
3. Close the control panel.
4. Touch the  touch button. The appliance is rinsed. As soon as the wash cycle has finished, an audible signal sounds.

Second wash cycle

1. Open the control panel.
2. Remove the water tank, rinse thoroughly, fill with water and reinsert.
3. Close the control panel.
4. Touch the  touch button. The appliance is rinsed. As soon as the wash cycle has finished, an audible signal sounds.

Final cleaning

1. Open the control panel.
2. Empty and dry the water tank.
3. Switch off the appliance. Descaling is complete and the appliance is ready for use again.

Rails

With good care and cleaning, your appliance will retain its appearance and remain fully functional for a long time to come. This will tell you how to remove the shelves and clean them.

Changing the shelf position for the telescopic rail

Bars and telescopic rails can be positioned in any order. For example, you can fit the telescopic rail to the shelf position which you use the most frequently.

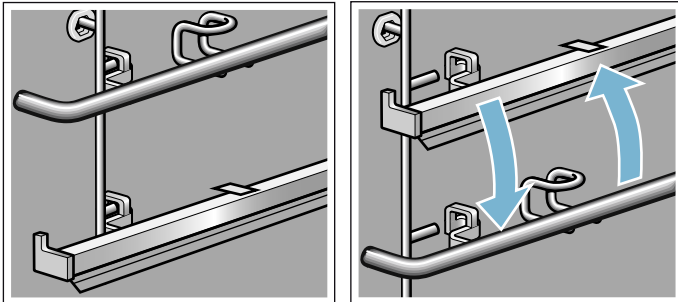

Removing the bar

Telescopic rails are removed and fitted like bars.

1. Push the bar towards the back **a** until it can be pulled out upwards **b** (Fig. **1**).
2. Unhook the bar at the back and remove it (Fig. **2**).

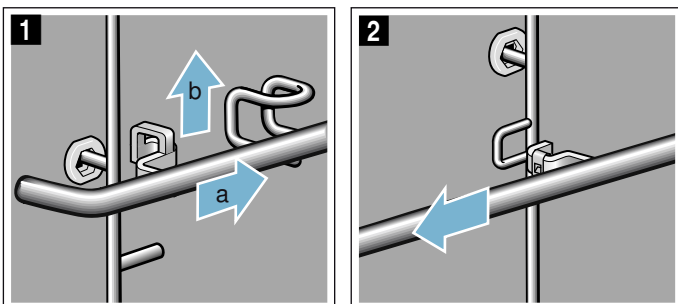

Fitting the bar

1. Fit the bar at the back (Fig. **1**).

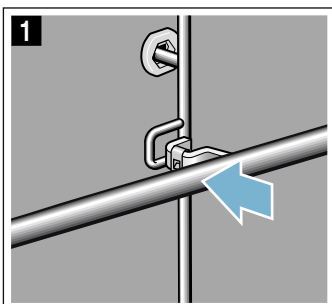

2. Push the bar towards the back **a** and down **b** onto the pin **c** (Fig. **2**).

3. Ensure that the hook is hooked onto the pin **c** (Fig. **3**).

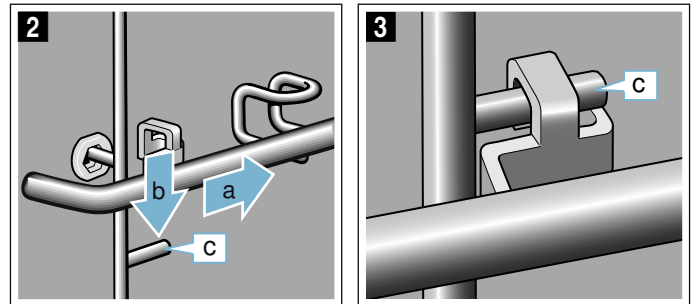

Detaching and refitting the rails

Warning – Risk of burns!

The rails become very hot. Never touch the hot rails. Always allow the appliance to cool down. Keep children away from the appliance.

Detaching the rails

1. Lift the rail slightly at the front **a** and detach it **b** (do not hold by the accessory holders or the telescopic shelf) (figure **1**).
2. Then pull the whole rail towards you and take it out (figure **2**).

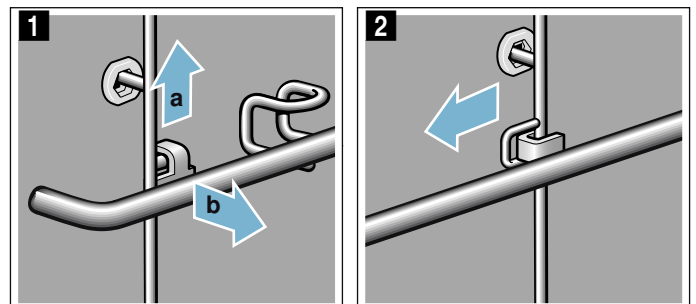

Clean the rails with cleaning agent and a sponge. For stubborn deposits of dirt, use a brush.

Attaching the rails

The rails only fit on the right or the left side. The pull-out rails must pull out towards you.

1. First, insert the rail in the middle of the rear socket **a**, until the rail rests against the cooking compartment wall, and push it back **b** (figure **1**).
2. Then insert the rail into the front socket **c**, until the rail also rests against the cooking compartment wall here, and press it downwards **d** (figure **2**).

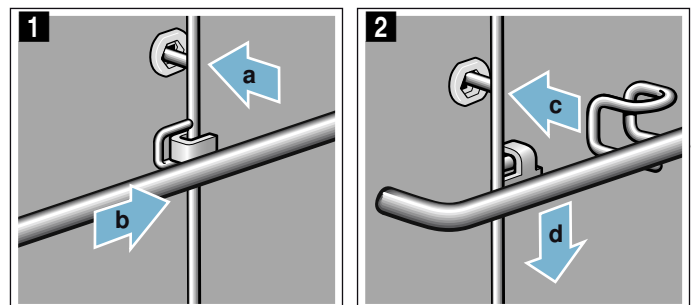

Appliance door

With good care and cleaning, your appliance will retain its appearance and remain fully functional for a long time to come. This will tell you how to remove the appliance door and clean it.

Removing and fitting the appliance door

To clean the door panels, you can detach the appliance door.

⚠ Warning – Risk of injury!

The hinges of the appliance door may snap shut with great force. Always fully turn the two locks for fitting and removing the appliance door.

⚠ Warning – Risk of injury!

If the appliance door has been removed without turning both locking levers to their limit stops, the hinge may snap shut. Do not reach into the hinge. Call the after-sales service.

Removing the appliance door

1. Open the left- and right-hand hinge lock (Fig. 1).
To do this, push the hinge lock (Fig. 2) fully upwards on both sides with a screwdriver.

Tip: Light up the gap using a torch so that you can find the hinge lock.

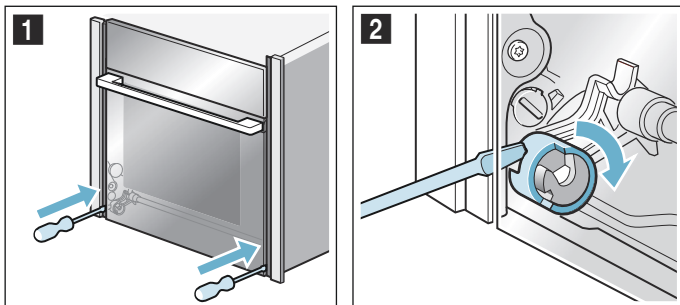

Hinge lock closed (Fig. 3)
Hinge lock opened (Fig. 4)

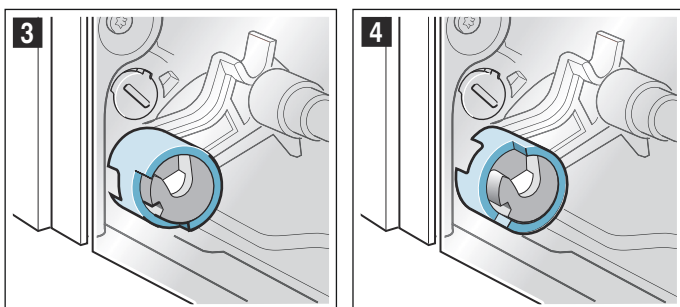

2. Open the appliance door a little (Fig. 5).
3. Using a coin, fully turn both the left- and right-hand locks on the inside of the appliance at the bottom (Fig. 6).
Left lock: Clockwise
Right lock: Anti-clockwise

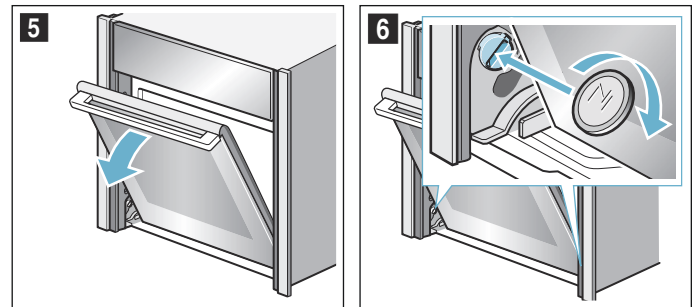

4. Close the appliance door a little, until you feel the locks engage.
The door can no longer be closed.
5. Lift the door handle slightly on the left- and right-hand side using both thumbs **a** and pull the appliance door out upwards **b** (Fig. 7).

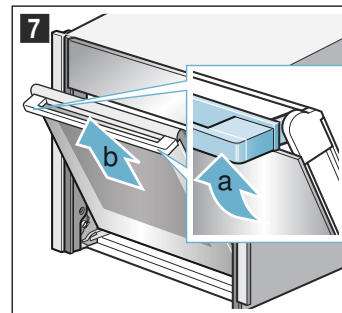

6. Lay the appliance door on an even, soft and clean surface.

Fitting the appliance door

1. Fit the appliance door (Fig. 1).
2. Fit the appliance door in the left and right-hand guide rollers simultaneously (Fig. 2).
Ensure that the appliance door does not tilt unevenly and that it is properly fitted in place.

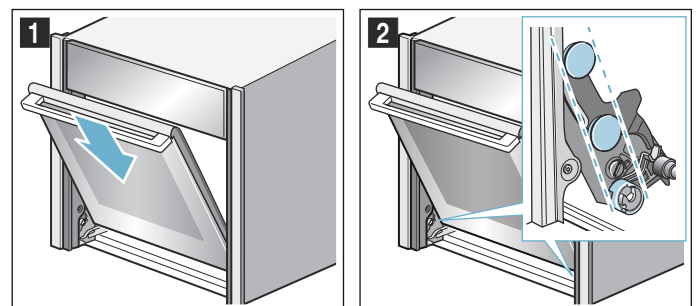

3. Turn the door handle upwards slightly **a** so that the appliance door slides downwards fully **b** (Fig. 3).
4. Use a coin to release both locks on the appliance door (Fig. 4).

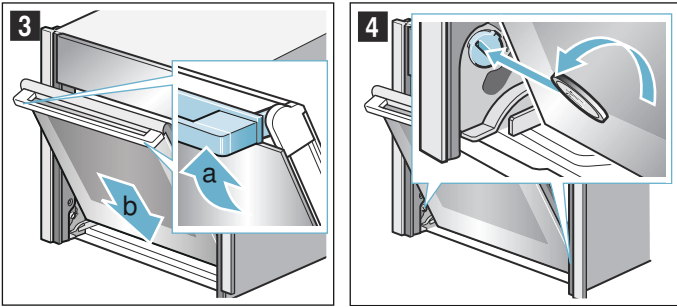

Left lock: Anti-clockwise
Right lock: Clockwise

5. Open the appliance door a little wider and then close it.

⚠ Warning

Risk of injury from hinge locks which have not been properly closed!

The appliance door may detach itself. You may be injured and the appliance door damaged. After refitting the door, always close the left- and right-hand hinge locks.

6. Close the left- and right-hand hinge locks (Fig. 5). To do this, push the hinge lock downwards on both sides with a screwdriver (Fig. 6).

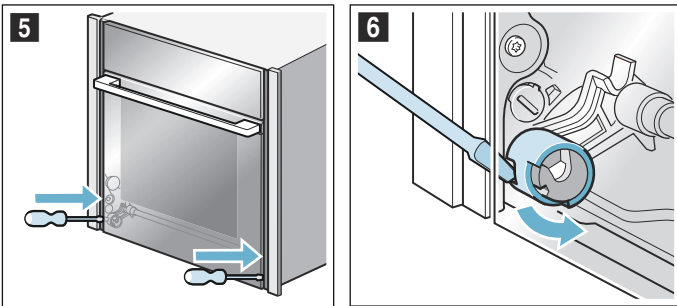

Removing and installing the door panels

For cleaning, you can remove the glass panels from the appliance door.

To do this, the appliance door must be removed beforehand (see section "Removing and fitting the appliance door").

⚠ Warning – Risk of injury!

The appliance must not be used again until the door panels and appliance door have been correctly fitted.

⚠ Warning – Risk of injury!

Components inside the appliance door may have sharp edges. Wear protective gloves.

Removal

Note: Lay the removed glass panels on an even, soft and clean surface.

1. Remove the appliance door.
2. Lay the appliance door with the front side facing down on an even, soft and clean surface.
3. Push on the left- and right-hand side on the outside of the appliance door until the inner glass is released on both sides (Fig. 1).
4. Carefully lift the inner glass and remove it in the direction of the arrow (Fig. 2).

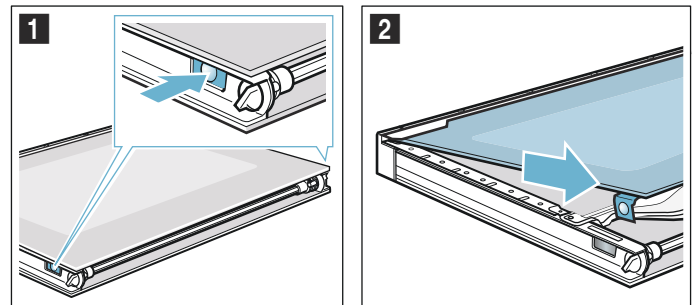

5. Push the intermediate panel downwards in the **a** area, carefully lift the **b** holder until it can be pulled out (Fig. 3).

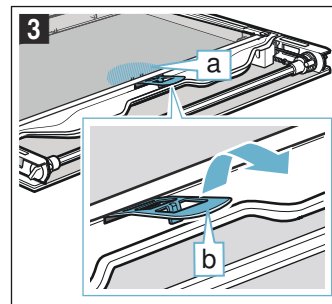

6. Lift the first and second intermediate panels from below (Fig. 4) and remove them in the direction of the arrow (Fig. 5).

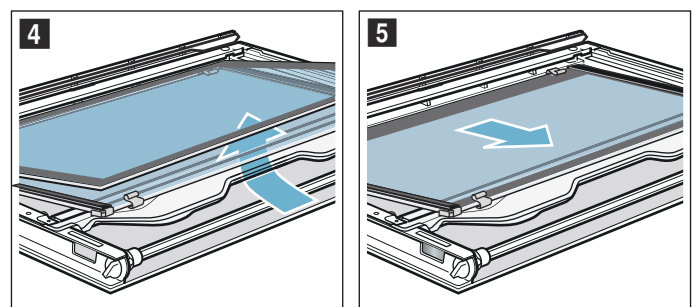

7. If required, remove the spacers (Fig. 6) and seals (Fig. 7) for cleaning.

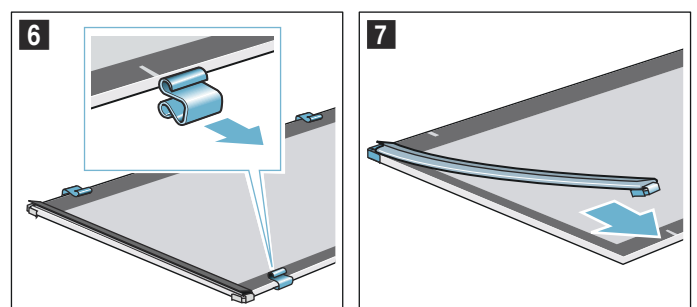

8. Clean the door panels on both sides with glass cleaner and a soft cloth.

⚠ Warning
Risk of injury!

Scratched glass in the appliance door may develop into a crack. Do not use a glass scraper, or sharp or abrasive cleaning aids or detergents.

9. Dry and refit the door panels.

Installation

Note: When fitting the door panels, ensure that they are in the original order.

1. Insert the intermediate glass so that the **a** arrow is facing upwards on the right-hand side (Fig. **1**).

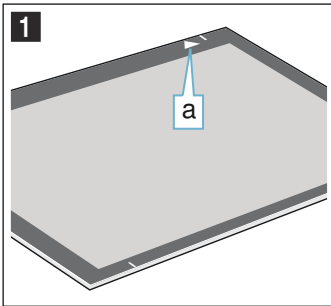

2. Check the fit of the four spacers and two seals on the intermediate panel:
- Place the spacers centrally on each edge (Fig. **2**).
 - Secure the seals at the corners (Fig. **3**).

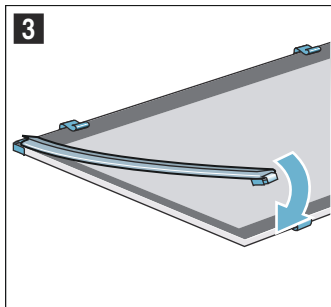
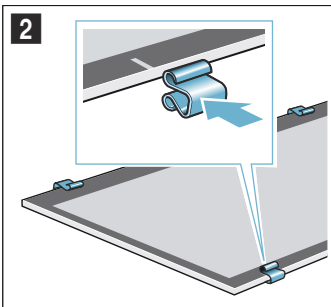

3. Insert the intermediate panel with the seals and spacers. The arrow on the intermediate panel must line up with the arrow on the frame (Fig. **4**).
4. Insert the second intermediate panel without the seals and spacers and push it in the direction of the arrow until it is fitted in the frame. The arrow on the intermediate panel must line up with the arrow on the frame (Fig. **5**).

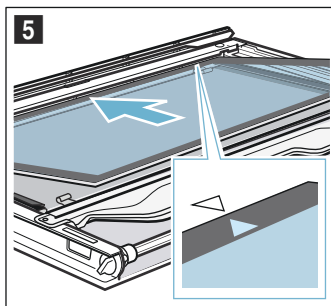
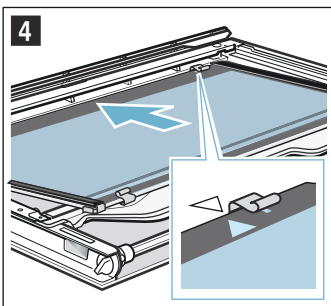

5. Push the intermediate panel downwards in the **b** area, insert the **c** holder at an angle and push down until it locks into place (Fig. **6**). The holder is inserted (Fig. **7**).

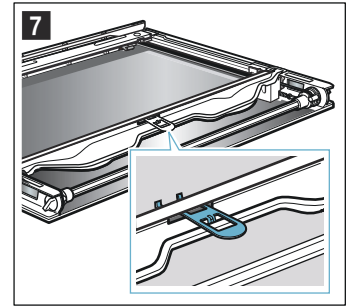
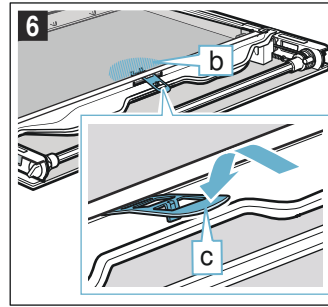

6. Insert the inner glass into the mounting rail **d** at an angle towards the back (Fig. **8**).
7. Push the inner glass downwards until it locks into place (Fig. **9**).

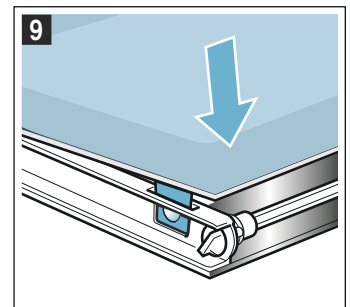
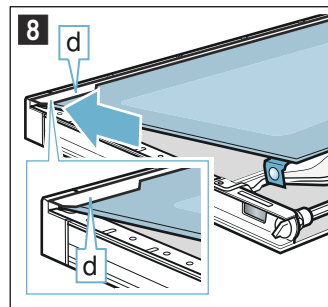

Trouble shooting

If a fault occurs, there is often a simple explanation. Before calling the after-sales service, please refer to the fault table and attempt to correct the fault yourself.

Tip: If a meal does not turn out exactly as you wanted, refer to the "Tested for you in our cooking studio" section. Here, you will find plenty of cooking tips and notes.

Fault table













 **Warning – Risk of electric shock!**

- Work on the appliance electronics may only be performed by a specialist.
- Always disconnect the appliance from the power supply when work is carried out on the electronics. Switch off the circuit breaker or remove the fuse from your household fuse box.

 **Warning – Risk of electric shock!**

Incorrect repairs are dangerous. Repairs may only be carried out and damaged power cables replaced by one of our trained after-sales technicians. If the appliance is defective, unplug the appliance from the mains or switch off the circuit breaker in the fuse box. Contact the after-sales service.

| Fault | Possible cause | Notes/remedy |
|--|--|---|
| The appliance does not work | The plug is not plugged into the mains | Connect the appliance to the power supply |
| | Power cut | Check whether other kitchen appliances are working |
| | The circuit breaker is faulty | Check in the fuse box to make sure that the fuse for the appliance is OK |
| Operations with steam or descaling do not start or do not continue | Water tank empty | Refill water tank |
| | The panel is open | Close the panel |
| | Descaling locks operations with steam | Carry out descaling |
| | Faulty sensor | Call the after-sales service |
| After switching on an operating mode, a message is shown on the display which indicates that the temperature is too high | The appliance has not cooled down sufficiently | Allow the appliance to cool down and switch the operating mode on again |
| The appliance prompts you to rinse | The power supply was interrupted or the appliance was switched off during the descaling process | Once the appliance is switched on again, rinse it twice |
| The appliance prompts you to descale without the counter appearing beforehand | The set water hardness range is too low | Carry out descaling Check the set water hardness range and adjust it, if necessary |
| Buttons flash | Normal occurrence caused by condensation behind the control panel | As soon as the condensation has evaporated, the buttons no longer flash |
| Cooked dishes turn out too moist or too dry when cooking with steam-assisted applications | The wrong steam intensity was selected | Select a higher or lower steam intensity |
| The "Fill water tank" message appears even though the water tank is full | The panel is open | Close the panel |
| | The water tank is not clicked into place | Click the water tank into place → "Steam" on page 17 |
| | Faulty sensor | Call the after-sales service |
| | The water tank has fallen off. Due to the impact, components inside the water tank have come loose, and the tank is leaking. | Order a new water tank |
| Steam escapes from the ventilation slots during cooking | Normal procedure | Not possible |

| | | |
|---|--|---|
| The panel for removing the tank does not open | The plug is not plugged into the mains | Connect the appliance to the power supply |
| | Power cut | Check whether other kitchen appliances are working |
| | The circuit breaker is faulty | Check in the fuse box to make sure that the fuse for the appliance is OK |
| | Faulty sensor for the  touch button | Call the after-sales service If required, empty the water tank: Open the appliance door, take hold of the lower part of the panel on the left and right with your fingers and pull out the panel |
| The appliance cannot be switched on; the  symbol is shown on the display | The automatic childproof lock is activated | Press and hold the  touch button until the  symbol goes out |
| The appliance cannot be operated when it is switched on; the  symbol is shown on the display | The childproof lock is activated | Press and hold the  touch button until the  symbol goes out |
| The appliance does not heat up;  is shown on the display | Demo mode is activated in the basic settings | Disconnect the appliance from the mains for approx. 10 seconds (switch off the circuit breaker in the fuse box) and then deactivate demo mode in the basic settings within 3 minutes → "Basic settings" on page 22 |
| The appliance door cannot be opened; the  symbol is shown on the display | The appliance door is locked until the cooking compartment has cooled down | Wait until the  symbol goes out |
| | The childproof lock locks the appliance door | Press and hold the  touch button until the  symbol goes out; adjust the childproof lock setting |
| There is a "pop" noise during cooking | Cold/warm effect with frozen food, caused by the steam | Not possible |
| "EXXXX" appears on the display, e.g. "E0111" | Technical problem | Switch the appliance off and back on again If the message appears again, call the after-sales service |

Maximum operating time exceeded

Your appliance ends the operation automatically when no cooking time is set and the setting has not been changed for a long time.

The actual cooking time until the operation is stopped automatically varies according to the selected settings.

The appliance display indicates that the operation will end automatically. Afterwards, the operation is stopped.

To use the appliance again, switch it off beforehand. Then switch the appliance on again and set the required operation.

Cooking compartment bulbs

To light the interior of your cooking compartment, your appliance has one or more long-life LED bulbs.

However, if ever an LED bulb or the bulb's glass cover is defective, call the after-sales service. The lamp cover must not be removed.

Customer service

Our after-sales service is there for you if your appliance needs to be repaired. We will always find an appropriate solution, also in order to avoid after-sales personnel having to make unnecessary visits.

E number and FD number

When calling us, please give the full product number (E no.) and the production number (FD no.) so that we can provide you with the correct advice. The rating plate bearing these numbers can be found on the right-hand side when you open the fascia panel. Touch the  touch button to do this. → "Steam" on page 17

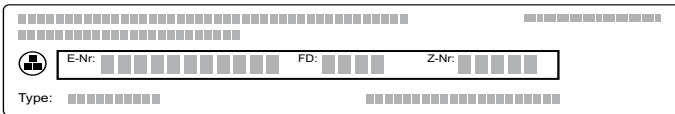

To save time, you can make a note of the number of your appliance and the telephone number of the after-sales service in the space below, should it be required.

| E no. | FD no. |
|-------|--------|
|-------|--------|

After-sales service

Please note that there will be a fee for a visit by a service technician in the event of a malfunction, even during the warranty period.

Please find the contact data of all countries in the enclosed customer service list.

To book an engineer visit and product advice

GB 0344 892 8989

Calls charged at local or mobile rate.

IE 01450 2655

0.03 € per minute at peak. Off peak 0.0088 € per minute.

Rely on the professionalism of the manufacturer. You can therefore be sure that the repair is carried out by trained service technicians who carry original spare parts for your appliances.

Tested for you in our cooking studio

Here, you can find a selection of dishes and the ideal settings for them. We will show you which type of heating and temperature are best suited to your dish. You will get information on suitable cooking accessories and the height at which they should be placed in the oven. You will also get tips about cookware and preparation methods.

Note: A lot of steam can build up in the cooking compartment when cooking food.

Your appliance is very energy-efficient and radiates very little heat to its surroundings during operation. Due to the high difference in temperature between the appliance interior and the external parts of the appliance, condensation may build up on the door, control panel or adjacent kitchen cabinet panels. This is a normal physical phenomenon. Condensation can be reduced by preheating the oven or opening the door carefully.

During operation with steam assistance, it is desirable that there is a significant build-up of steam in the cooking compartment. Wipe the cooking compartment clean after cooking, once it has cooled off.

Silicone moulds

We recommend dark-coloured metal baking tins for ideal cooking results.

Nevertheless, if you wish to use silicone moulds, follow the manufacturer's instructions and recipes. Silicone moulds are often smaller than normal baking tins. Quantity and recipe specifications may vary.

Silicone moulds are unsuitable for steam-assisted cooking.

Baking

Here, you can find recommended settings for many dishes.

Also refer to the notes in the section on allowing dough to rise.

Only use original accessories supplied with your appliance. These have been tailored to the cooking compartment and the operating modes of your appliance.

Steam- assisted baking

Certain types of baked item (e.g. yeast-risen pastries) get a more crispy crust and a more glossy surface if baked with the steam assist mode. The baked item does not dry out as much.

Steam-assisted baking is only possible on one level.

Some food turns out better if it is baked in several stages. These dishes are indicated in the table.

Shelf positions

Use the indicated shelf positions.

Baking on one level

When baking on one level, use the following shelf positions:

- Tall baked items: Level 2
- Flat baked items: Level 3

If you are using CircoTherm Hot air as the type of heating, you can choose between levels 1, 2, 3 and 4.

You can also prepare soufflés in a water bath in the universal pan. To do so, slide the universal pan in at level 2.

Baking on two levels

Use CircoTherm. Baked items that are placed into the oven on trays or in baking tins/dishes at the same time will not necessarily be ready at the same time.

- Universal pan: Level 3
Baking tray: Level 1
- Baking tins/dishes on the wire rack
First wire rack: Level 3
Second wire rack: Level 1

By preparing several dishes at the same time, you can make energy savings of up to 45 per cent. Position baking tins/dishes next to one another or offset and vertically stacked in the cooking compartment.

Accessories

Ensure that you always use suitable accessories and that they are placed in the oven the right way around.

Wire rack

Insert the wire rack with the open side facing the appliance door and the outer rail pointing downwards.

Universal pan or baking tray

Slide the universal pan or the baking tray in carefully as far as the limit stop with the bevelled edge facing the appliance door.

When baking moist cakes or pastries with many toppings, use the universal pan so that any excess liquid does not overflow and make the cooking compartment dirty.

Baking tins

Dark- coloured metal baking tins are most suitable.

Tinplate baking tins, ceramic dishes and glass dishes extend baking time and mean that the baked item will not brown evenly. If you wish to bake using these baking tins/dishes and using top/bottom heating, slide in the tin/dish at level 1.

The baking tins must be resistant to heat and steam for use in steam-assisted baking.

Greaseproof paper

Only use greaseproof paper that is suitable for the selected temperature. Always cut greaseproof paper to size.

Recommended setting values

You can find the ideal heating type for various pastries in the table. The temperature and baking time are dependent on the quantity and composition of the dough. Different settings ranges are indicated for this reason. Try using the lower values at first. A lower temperature results in more even browning. If necessary, use a higher setting the next time.

Note: Baking times can not be reduced by using higher temperatures. Cakes or small baked items would only be cooked on the outside, and would not be fully baked in the middle.





The setting values apply to dishes placed into a cold cooking compartment. By doing so, you can make energy savings of up to 20 per cent. If you preheat the oven, you can reduce the indicated baking times by several minutes.

Preheating is necessary for selected dishes, and this is indicated in the table.

If you wish to follow one of your own recipes when baking, you should use a similar baked item in the table as a reference. You can find additional information in the tips on baking attached to the settings table.





Remove unused accessories from the cooking compartment. This will achieve the best possible cooking results and energy savings of up to 20 per cent.











































Types of heating used:









-  CircoTherm hot air
-  Top/bottom heating
-  Pizza setting
-  Bread baking setting

The levels of steam intensity are indicated as numbers in the table:

- 1 = Low
- 2 = Medium
- 3 = High

| Dish | Accessories/cookware | Shelf position | Type of heating | Temperature in °C | Steam intensity | Cooking time in mins. |
|-------------------------|----------------------|----------------|---|-------------------|-----------------|-----------------------|
| One level baking | | | | | | |
| Victoria sponge cake | 2x Ø20 cm tins | 2 |  | 160-170* | - | 25-30 |
| Victoria sponge cake | 2x Ø20 cm tins | 2 |  | 150-160 | 1 | 25-35 |
| Light fruit cake | high Ø20 cm tin | 2 |  | 140-160* | - | 70-90 |
| Light fruit cake | high Ø20 cm tin | 2 |  | 140-150 | 1 | 90-100 |
| Rich fruit cake | high Ø23 cm tin | 2 |  | 130-150* | - | 150-180 |
| * Preheat | | | | | | |

| Dish | Accessories/cookware | Shelf position | Type of heating | Temperature in °C | Steam intensity | Cooking time in mins. |
|--------------------------------|---------------------------------|----------------|--|-------------------|-----------------|-----------------------|
| Fruit crumble | flat glass dish | 3 |  | 150-170* | - | 35-45 |
| Sponge Cake (fatless), 3 eggs | springform cake tin Ø26 cm | 2 |  | 160-170* | - | 25-35 |
| Sponge Cake (fatless), 3 eggs | springform cake tin Ø26 cm | 2 |  | 150-160 | 1 | 10 |
| | | | | | - | 20-25 |
| Sponge flan, 6 eggs | springform cake tin Ø28 cm | 2 |  | 150-170* | - | 30-50 |
| Sponge flan, 6 eggs | springform cake tin Ø28 cm | 2 |  | 150-160 | 1 | 10 |
| | | | | | - | 30-35 |
| Swiss roll | swiss roll tin | 3 |  | 180-190* | - | 10-15 |
| Swiss roll | swiss roll tin | 3 |  | 180-190* | 1 | 10-15 |
| Tart | plate Ø20 cm or pie tin | 2 |  | 160-170* | - | 50-60 |
| Tart | plate Ø20 cm or pie tin | 2 |  | 170-190* | - | 50-65 |
| Quiche | quiche tin (dark coated) | 3 |  | 190-210 | - | 30-40 |
| (White) Bread | loaf tin (1x 900 g or 2x 450 g) | 2 |  | 180-200* | - | 20-30 |
| (White) Bread | loaf tin (1x 900 g or 2x 450 g) | 2 |  | 190-200 | 2 | 30-40 |
| Scones | baking tray | 3 |  | 180-200* | - | 10-14 |
| Scones | baking tray | 3 |  | 190-200 | - | 10-14 |
| Biscuits | baking tray | 3 |  | 140-160* | - | 10-25 |
| Biscuits | baking tray | 3 |  | 150-170 | - | 10-20 |
| Small Cakes | 12-cup-tin | 3 |  | 140-160* | - | 20-30 |
| Small Cakes | 12-cup-tin | 3 |  | 150-170 | - | 20-30 |
| Puff pastry slices | baking tray | 3 |  | 170-190* | - | 20-35 |
| Puff pastry slices | baking tray | 3 |  | 200-220* | 1 | 15-25 |
| Jam tarts | 12-cup-tin | 3 |  | 170-190* | - | 15-30 |
| Jam tarts | 12-cup-tin | 3 |  | 180-200 | - | 15-25 |
| Meringue | baking tray | 3 |  | 80-90* | - | 120-150 |
| Pavlova | baking tray | 3 |  | 90-100* | - | 120-180 |
| Soufflé | 1,2L-soufflé dish | 2 |  | 160-170* | - | 35-45 |
| Soufflé | 1,2L-soufflé dish | 2 |  | 160-180 | 2 | 35-45 |
| Soufflé | individual moulds | 2 |  | 170-190 | - | 65-75 |
| Choux pastry | baking tray | 3 |  | 190-210* | - | 30-40 |
| Choux pastry | baking tray | 3 |  | 200-220* | 1 | 25-35 |
| Pie | rectangular pie tin | 2 |  | 170-190 | - | 50-70 |
| Pie | rectangular pie tin | 2 |  | 170-180 | 2 | 40-50 |
| Yorkshire pudding | 12-cup-tin | 3 |  | 200-220* | - | 15-25 |
| Jacket potatoes | baking tray | 3 |  | 150-170* | - | 75-90 |
| Jacket potatoes | universal pan | 3 |  | 180-190 | 2 | 40-50 |
| Pizza, homemade | baking tray | 3 |  | 200-220 | - | 25-35 |
| Pizza, homemade | baking tray | 3 |  | 200-220 | - | 25-35 |
| Pizza, homemade, thin base | pizza tray | 2 |  | 250-270 | - | 20-25 |
| Pizza, homemade, thin base | pizza tray | 2 |  | 210-220 | - | 25-30 |
| Multishelf baking | | | | | | |
| Victoria Sponge Cake, 2 levels | 4x Ø20 cm tins | 3+1 |  | 160-170* | - | 25-35 |
| Scones, 2 levels | 2 baking trays | 3+1 |  | 170-190* | - | 12-16 |
| Biscuits, 2 levels | 2 baking trays | 3+1 |  | 140-160* | - | 10-25 |
| Biscuits, 3 levels | 3 baking trays | 4+3+1 |  | 140-160* | - | 15-30 |
| * Preheat | | | | | | |

| Dish | Accessories/cookware | Shelf position | Type of heating | Temperature in °C | Steam intensity | Cooking time in mins. |
|------------------------------|-----------------------------|----------------|---|-------------------|-----------------|-----------------------|
| Small cakes, 2 levels | 2x 12-cup-tins | 3+1 |  | 140-160* | - | 22-32 |
| Puff pastry slices, 2 levels | 2 baking trays | 3+1 |  | 170-190* | - | 25-45 |
| Puff pastry slices, 3 levels | 3 baking trays | 4+3+1 |  | 170-190* | - | 25-45 |
| Jam tarts, 2 levels | 2x 12-cup-tins | 3+1 |  | 170-190* | - | 20-35 |
| Meringues, 2 levels | 2 baking trays | 3+1 |  | 80-90* | - | 120-150 |
| Jacket potatoes, 2 levels | universal pan + baking tray | 3+1 |  | 150-170* | - | 75-90 |
| (White) Bread, 2 levels | 4x loaf tins | 3+1 |  | 170-190* | - | 30-40 |
| Pizza, homemade, 2 levels | universal pan + baking tray | 3+1 |  | 180-200 | - | 35-45 |

* Preheat

Tips on baking

| | |
|---|---|
| You want to find out whether the cake is completely cooked in the middle. | Push a cocktail stick into the highest point on the cake. If the cocktail stick comes out clean with no dough residue, the cake is ready. |
| The cake collapses. | Next time, use less liquid. Alternatively, set the temperature to be 10 °C lower and extend the baking time. Adhere to the specified ingredients and preparation instructions in the recipe. |
| The cake has risen in the middle but is lower around the edge. | Only grease the base of the springform cake tin. After baking, loosen the cake carefully with a knife. |
| The fruit juice overflows. | Next time, use the universal pan. |
| Small baked items stick to one another during baking. | There should be a gap of approx. 2 cm around each item. This gives enough space for the baked items to expand well and brown on all sides. |
| The cake is too dry. | Set the temperature 10 °C higher and shorten the baking time. |
| The cake is generally too light in colour. | If the shelf position and the cookware are correct, then you should increase the temperature if necessary or extend the baking time. |
| The cake is too light on top, and too dark underneath. | Bake the cake one level higher in the oven the next time. |
| The cake is too dark on top, and too light underneath. | Bake the cake one level lower in the oven the next time. Select a lower temperature and extend the baking time. |
| Cakes baked in a tray or tin are too brown at the back. | Place the baking tray in the middle of the accessories, not directly against the back wall. |
| The whole cake is too dark. | Select a lower temperature next time and extend the baking time if necessary. |
| The cake is unevenly browned. | Select a slightly lower temperature. Protruding greaseproof paper can affect the air circulation. Always cut greaseproof paper to size. Ensure that the baking tin does not stand directly in front of the openings in the cooking compartment back wall. When baking small items, you should use similar sizes and thicknesses wherever possible. |
| You were baking on several levels. The items on the top baking tray are darker than those on the lower baking tray. | Always use CircoTherm when baking on several levels. Baked items that are placed into the oven on trays or in baking tins/dishes at the same time will not necessarily be ready at the same time. |
| The cake looks good, but is not cooked properly in the middle. | Use a lower temperature and bake slightly longer; if necessary, add slightly less liquid. For cakes with a moist topping, bake the base first. Sprinkle it with almonds or breadcrumbs and then place the topping on top. |
| The cake cannot be turned out of the dish when it is turned upside down. | Allow the cake to cool down for 5 to 10 minutes after baking. If it still sticks, carefully loosen the cake around the edges again using a knife. Turn the cake tin upside down again and cover it several times with a cold, wet cloth. Next time, grease the baking tin/dish and sprinkle with breadcrumbs. |

Roasting and braising

Here, you can find information on roasting and braising poultry and meat. You can find the ideal settings for many dishes in the settings tables.

Poultry

For duck or goose, pierce the skin on the underside of the wings. This allows the fat to run out.

If using duck breast, score the skin. Do not turn duck breasts.

When you turn poultry, ensure that the breast side or the skin side is underneath at first.

Poultry will turn out particularly crispy and brown if you baste it towards the end of the roasting time with butter, salted water or orange juice.

Meat

Baste lean meat with fat as required or cover it with strips of bacon.

Score the rind crosswise. If you turn the joint when cooking, ensure that the rind is underneath at first.

When the joint is ready, turn off the oven and allow it to rest for another 10 minutes in the cooking compartment. This allows the meat juices to be better distributed. Wrap the joint in aluminium foil if necessary. The recommended resting time is not included in the cooking time indicated.

Roasting on the wire rack

On the wire rack, poultry and meat will become very crispy on all sides. Roasting on the wire rack is well suited for larger poultry or for multiple pieces at the same time.

Depending on the size and type of the meat, add up to ½ litres of water to the universal pan. Any dripping fat and meat juices will be caught. You can prepare a sauce using these meat juices. In addition, less smoke is generated, and the cooking compartment stays cleaner.

Slide the universal pan into the oven at the indicated shelf position with the wire rack attached. Ensure that the wire rack is correctly positioned on the universal pan. → "Accessories" on page 12

Roasting and braising in cookware

It is more convenient to roast and braise meat in cookware. You can take the joint out of the cooking compartment more easily in the cookware, and prepare the sauce in the cookware itself.

Only use cookware which is suitable for use in an oven. Check whether the cookware fits in the cooking compartment.

Glass cookware is most suitable. Place hot glass cookware onto a dry mat after cooking. If the surface is damp or cold, the glass may crack.

Add in a little liquid for roasting if the meat is lean. A covering of approx. ½ cm depth should be applied to the base of any glass cookware.

The amount of liquid is dependent on the type of meat, the cookware material and also on whether or not a lid is used. If preparing meat in an enamelled or dark metal roasting dish, it will need a little more liquid than if cooked in glass cookware.

The steam evaporates in the cookware when roasting. Carefully pour in more liquid if required.

Shiny roasting dishes made from stainless steel or aluminium reflect heat like a mirror and are therefore not particularly suitable. The meat cooks more slowly and will not brown so much. Use a higher temperature and/or a longer cooking time.

Observe the manufacturer's instructions for your roasting cookware.

Roasting in uncovered cookware

It is best to use a deep roasting tin/dish for roasting poultry and meat. Place the tin/dish onto the wire rack. If you do not have any suitable cookware, use the universal pan.

Braising in covered cookware

When preparing food with covered cookware, the cooking compartment remains considerably cleaner. Ensure that the lid fits well and closes properly. Place the cookware onto the wire rack.

The distance between the meat and the lid must be at least 3 cm. The meat may rise.

Very hot steam may escape when opening the lid after cooking. Lift the lid at the rear, so that the hot steam can escape away from you.

If necessary, braise the meat first by searing it. Add water, wine, vinegar or a similar liquid to the braising liquid. A covering at least 2 cm deep should be applied to the base of the cookware.

The steam evaporates in the cookware when roasting. Carefully pour in more liquid if required.

Steam- assisted roasting and braising

Certain dishes become crispier if cooked using steam, and do not dry out as much.

Use uncovered cookware. Cookware must be heat- and steam-resistant.

The joints do not have to be turned.

Use steam-assisted cooking if it is indicated in the settings table. Some dishes turn out best if they are cooked in several stages. These are indicated in the table.

Recommended setting values

In the table, you can find the ideal heating type for poultry and meat. Temperature and cooking time depend on the quantity, composition and temperature of the food. Different settings ranges are indicated for this reason. Try using the lower values at first. You can increase the temperature next time if necessary.

The setting values are based on the assumption that unstuffed, chilled, ready-to-roast poultry and meat are placed into a cold cooking compartment. By doing so, you can make energy savings of up to 20 per cent. If you preheat the oven, the indicated cooking times will be reduced by several minutes.

In the table, you can find specifications for poultry and meat with default values for the weight. If you wish to prepare heavier poultry or meat, use the lower temperature in every case. If roasting several joints, use the weight of the heaviest piece as a basis for determining the cooking time. The individual pieces should be approximately equal in size.

A general rule: the larger the poultry or piece of meat is, the lower the cooking temperature and the longer the cooking time.

Turn the poultry and meat after approx. ½ to ¾ of the indicated time.

























Remove unused accessories from the cooking compartment. This will achieve the best possible cooking results and energy savings of up to 20 per cent.













Type of heating used:

-  CircoTherm hot air

The levels of steam intensity are indicated as numbers in the table:

- 1 = Low
- 2 = Medium

| Dish | Accessories/cookware | Shelf position | Type of heating | Temperature in °C | Steam intensity | Cooking time in mins. |
|---------------------------------|----------------------|----------------|---|-------------------|-----------------|-----------------------|
| Beef | | | | | | |
| Slow roast joint | wire rack | 2 |  | 130-140* | - | 40+40 |
| Slow roast joint, 1,5 kg | wire rack | 2 |  | 130-140 | 1 | 50-60 |
| | | | | | - | 40-50 |
| Top side / Top rump | wire rack | 2 |  | 160-170* | - | 30+25 |
| Top side / Top rump 1,5 kg | wire rack | 2 |  | 170-180 | 1 | 100-120 |
| Lamb | | | | | | |
| Leg (bone-in) | wire rack | 2 |  | 160-170* | - | 30+25 |
| Leg (bone-in), 1,5 kg | wire rack | 2 |  | 180-190 | 1 | 80-90 |
| Shoulder (bone-in) | wire rack | 2 |  | 160-170* | - | 25+20 |
| Shoulder (boned and rolled) | wire rack | 2 |  | 170-180* | - | 25+25 |
| Rack of lamb | wire rack | 2 |  | 180-190* | - | 25+25 |
| Rack of lamb (each 700 g) | wire rack | 2 |  | 200 | - | 20 |
| | | | | 170-180 | 1 | 25-30 |
| Pork | | | | | | |
| Roast joint | wire rack | 2 |  | 180-190* | - | 35+35 |
| Roast joint, 1,5 kg | wire rack | 2 |  | 120 | 3 | 30 |
| | | | | 190-200 | - | 30 |
| | | | | 160-170 | 1 | 80-100 |
| Loin joint | wire rack | 2 |  | 170-180* | - | 30+30 |
| Loin joint, 1 kg | wire rack | 2 |  | 180-190 | - | 25-30 |
| | | | | 170-180 | 1 | 70-80 |
| Belly | wire rack | 2 |  | 160-170* | - | 30+25 |
| Gammon joint | wire rack | 2 |  | 160-170* | - | 30+30 |
| Gammon joint, 1,5 kg | wire rack | 2 |  | 170-180 | 2 | 100-120 |
| Poultry | | | | | | |
| Chicken, whole | wire rack | 2 |  | 170-180* | - | 25+25 |
| Chicken, whole, 1,5 kg | wire rack | 2 |  | 180-190 | 2 | 65-75 |
| Chicken, portion (je 200-250 g) | wire rack | 2 |  | 190-200* | - | 35-45 |
| Chicken, portion (je 200-250 g) | wire rack | 2 |  | 200-210 | 2 | 35-45 |
| Chicken, quarter (je 450 g) | wire rack | 2 |  | 180-190* | - | 40-60 |
| Chicken, quarter (je 450 g) | wire rack | 2 |  | 190-200 | 2 | 45-55 |
| Duck, 2-3 kg | wire rack | 2 |  | 180-190* | - | 20+20 |
| * Preheat | | | | | | |

| Dish | Accessories/cookware | Shelf position | Type of heating | Temperature in °C | Steam intensity | Cooking time in mins. |
|-------------------------------|---------------------------------------|----------------|--|-----------------------------------|-----------------|--|
| Duck, 2-3 kg | wire rack | 2 |  | 160-170 | 2 | 70-90 |
| | | | | 170-180 | - | 30-40 |
| Turkey, crown | wire rack | 2 |  | 160-170* | - | 20+15 |
| Turkey, drumstick | wire rack | 2 |  | 160-170* | - | 25+25 |
| Turkey, whole, 3-4 kg | wire rack | 2 |  | 160-170* | - | 15+10 |
| Turkey, whole, 4,5-12 kg | wire rack | 2 |  | 160-170* | - | 12+12 |
| Turkey, whole, 5 kg | wire rack | 1 |  | 140-150 | 2 | 120-150 |
| | | | | 170-180 | - | 30-40 |
| Meat dishes | | | | | | |
| Meat loaf | cookware, uncovered | 2 |  | 170-180* | - | 20+35 |
| Meat loaf, 1 kg | cookware, uncovered | 2 |  | 190-200 | 1 | 70-80 |
| Casserole | | | | | | |
| Diced meat (beef, pork, lamb) | cookware, covered | 2 |  | 140 | - | 60+120 |
| Braising steak | cookware, covered | 2 |  | 140 | - | 65+120 |
| Chicken pieces (boned) | cookware, covered | 2 |  | 140 | - | 70+110 |
| Complete meal | | | | | | |
| With beef | wire rack + wire rack + universal pan | 4+1 |  | 160, then 200 (yorkshire pudding) | - | weight of meat (see table above) + 15-25 for yorkshire pudding |
| With chicken | wire rack + wire rack + universal pan | 4+1 |  | 180 | - | weight of chicken (see table above) |
| * Preheat | | | | | | |

Tips on roasting and braising

| | |
|---|--|
| The cooking compartment becomes very dirty. | Prepare your food in an enclosed roasting dish with higher temperature or use the grill tray. You will achieve the best roasting results if you use the grill tray. The grill tray can be bought later as a special accessory. |
| The roast is too dark and the crackling is burned in places, and/or the roast is too dry. | Check the shelf position and temperature. Select a lower temperature the next time and reduce the roasting time if necessary. |
| The crackling is too thin. | Increase the temperature or switch on the grill briefly at the end of the roasting time. |
| The roast looks good but the juices are burnt. | Next time, use a smaller roasting dish and add more liquid if necessary. |
| The roast looks good but the juices are too clear and watery. | Next time, use a larger roasting dish and add less liquid if necessary. |
| The meat gets burned during braising. | The roasting dish and lid must fit together well and close properly. Reduce the temperature and add more liquid when braising if necessary. |

Grilling

Here, you can find information on grilling poultry, meat and fish, as well as toast. You can find the ideal settings for certain dishes in the settings tables.

Grilling with circo-roasting

Circo-roasting is very well suited to the preparation of whole poultry and fish, in addition to meat, e.g. roast pork with crackling.

Poultry

For duck or goose, pierce the skin on the underside of the wings. This allows the fat to run out.

If using duck breast, score the skin. Do not turn duck breasts.

When you turn poultry, ensure that the breast side or the skin side is underneath at first.

Poultry will turn out particularly crispy and brown if you baste it towards the end of the roasting time with butter, salted water or orange juice.

Meat

Baste lean meat with fat as required or cover it with strips of bacon.

Score the rind crosswise. If you turn the joint when cooking, ensure that the rind is underneath at first.

When the joint is ready, turn off the oven and allow it to rest for another 10 minutes in the cooking compartment. This allows the meat juices to be better distributed. Wrap the joint in aluminium foil if necessary. The recommended resting time is not included in the cooking time indicated.

Fish

Fish cooked whole does not have to be turned. Place the whole fish into the cooking compartment in swimming position with the dorsal fin facing upwards. Placing half a potato or a small oven-proof container in the stomach cavity of the fish will provide stability.

You can tell when the fish is cooked because the dorsal fin can be removed easily.

Roasting on the wire rack

On the wire rack, poultry and meat will become very crispy on all sides. Roasting on the wire rack is well suited for larger poultry or for multiple pieces at the same time.

Depending on the size and type of the meat, add up to ½ litres of water to the universal pan. Any dripping fat and meat juices will be caught. You can prepare a sauce using these meat juices. In addition, less smoke is generated, and the cooking compartment stays cleaner.

Slide the universal pan into the oven at the indicated shelf position with the wire rack attached. Ensure that the wire rack is correctly positioned on the universal pan. → "Accessories" on page 12

Roasting in cookware

It is more convenient to roast and braise meat in cookware. You can take the joint out of the cooking compartment more easily in the cookware, and prepare the sauce in the cookware itself.

Only use cookware which is suitable for use in an oven. Check whether the cookware fits in the cooking compartment.

Glass cookware is most suitable. Place hot glass cookware onto a dry mat after cooking. If the surface is damp or cold, the glass may crack.

Add in a little liquid if the meat is lean. A covering of approx. ½ cm depth should be applied to the base of any glass cookware.

The quantity of liquid is dependent on the type of meat, the cookware material and also on whether or not a lid is used. If preparing poultry, meat or fish in an enamelled or dark metal roasting dish, it will need a little more liquid than if cooked in glass cookware.

The steam evaporates in the cookware when roasting. Carefully pour in more liquid if required.

Shiny roasting dishes made from stainless steel or aluminium reflect heat like a mirror and are therefore not particularly suitable. The meat cooks more slowly and will not brown so much. Use a higher temperature and/or a longer cooking time.

Observe the manufacturer's instructions for your roasting cookware.

Uncovered cookware

Use a deep roasting tin/dish for roasting meat. Place the tin/dish onto the wire rack. If you do not have any suitable cookware, use the universal pan.

Covered cookware

When cooking with covered cookware, the cooking compartment remains considerably cleaner. Ensure that the lid fits well and closes properly. Place the cookware onto the wire rack.

The distance between the meat and the lid must be at least 3 cm. The meat may rise.

Very hot steam may escape when opening the lid after cooking. Lift the lid at the rear, so that the hot steam can escape away from you.

If necessary, braise the meat first by searing it. Add water, wine, vinegar or a similar liquid to the braising liquid. A covering approx. 1-2 cm deep should be applied to the base of the cookware.

The steam evaporates in the cookware when roasting. Carefully pour in more liquid if required.

Meat can also become crispy in a covered roasting dish. To do so, use a roasting dish with a glass lid and set a higher temperature.

Steam- assisted roasting

Certain foodstuffs will become crispier during steam-assisted cooking. Their surface becomes glossier and they dry out less.

Use uncovered cookware. Cookware must be heat- and steam-resistant.

Use steam-assisted cooking if it is indicated in the settings table. Some dishes turn out best if they are cooked in several stages. These are indicated in the table.

Grilling flat pieces

Flat pieces of poultry, meat and fish, such as steaks, drumsticks and burgers, can be prepared well using the "Grill" heating type. Excellent results are also achieved when grilling toast.

Grilling

Keep the appliance door closed when using the grill. Never grill with the appliance door open.

Slide the universal pan into the oven at the indicated shelf position with the wire rack attached. Dripping fat will be collected. Ensure that the wire rack is positioned correctly on the universal pan. → "Accessories" on page 12

Note: When grilling very fatty items, do not slide the universal pan in directly under the wire rack, but rather at level 2.

When grilling, try wherever possible to use pieces of food which are of a similar thickness and weight. This will allow them to brown evenly and remain succulent and juicy. Place the food to be grilled directly onto the wire rack.

Use tongs to turn the pieces of food you are grilling. If you pierce the meat with a fork, the juices will run out and it will become dry.

Do not add salt to the meat until after it has been grilled. Salt draws water from the meat.

Notes

- The grill element switches itself on and off continuously; this is normal. The set temperature determines how frequently this occurs.
- Smoke may be produced when grilling.

Recommended setting values

In the table, you can find the ideal heating type for your poultry, meat and fish, in addition to toast. Temperature and cooking time depend on the quantity, composition and temperature of the food. Settings ranges are indicated for this reason. Try using the lower values at first. You can use a higher setting next time if necessary.

The setting values are based on the assumption that unstuffed, chilled, ready-to-roast poultry, meat and fish are placed into a cold cooking compartment.



In the table, you can find specifications for poultry, meat and fish with default values for the weight. If you wish to prepare heavier poultry, meat or fish, use the lower temperature in every case. If roasting several joints, use the weight of the heaviest piece as a basis for determining the cooking time. The individual pieces should be approximately equal in size.

A general rule: the larger the poultry, meat or fish is, the lower the cooking temperature and the longer the cooking time.

Turn the poultry, meat and fish after approx. 1/2 to 2/3 of the indicated time.





Remove unused accessories from the cooking compartment. This will achieve the best possible cooking results and energy savings of up to 20 per cent.





























Types of heating used:

-  Circo-roasting
-  Grill, large area

The levels of steam intensity are indicated as numbers in the table:

- 1 = Low
- 2 = Medium
- 3 = High

| Dish | Accessories | Shelf position | Type of heating | Temperature in °C | Steam intensity | Cooking time in mins. |
|---|-------------|----------------|--|-------------------|-----------------|--------------------------------|
| Beef | | | | | | |
| Steaks, height 2-3 cm** | wire rack | 4 |  | 290 | - | 1st side 10-12 2nd side 3-5 |
| Burger, height 1-2 cm | wire rack | 4 |  | 290* | - | 1st side 6-8 2nd side 4-6 |
| Slow roast joint | wire rack | 2 |  | 180-200 | - | 30+30 |
| Top side / Top rump | wire rack | 2 |  | 150-160 | - | 30+30 |
| * Preheat | | | | | | |
| ** Do not preheat | | | | | | |
| *** Preheat 3 minutes | | | | | | |
| **** Preheat 3 minutes, turn over several times | | | | | | |







| Dish | Accessories | Shelf position | Type of heating | Temperature in °C | Steam intensity | Cooking time in mins. |
|---|-------------|----------------|---|--------------------|-----------------|----------------------------------|
| Lamb | | | | | | |
| Steaks, height 2-3 cm | wire rack | 4 |  | 290* | - | 1st side 8-10 2nd side 4-6 |
| Chops, height 2-3 cm | wire rack | 4 |  | 290 | - | 1st side 7-9 2nd side 7-9 |
| Leg (bone-in) | wire rack | 2 |  | 160-180 | - | 30+30 |
| Leg (bone-in), 1,5 kg | wire rack | 2 |  | 170-180 | 1 | 80-90 |
| Shoulder (bone-in) | wire rack | 2 |  | 170-190 | - | 25+15 |
| Shoulder (boned and rolled) | wire rack | 2 |  | 170-190 | - | 25+20 |
| Rack of lamb | wire rack | 2 |  | 190-200 | - | 25+20 |
| Pork | | | | | | |
| Steaks, height 2 cm | wire rack | 4 |  | 290 | - | 1st side 10-12 2nd side 5-7 |
| Chops, height 2-3 cm | wire rack | 4 |  | 275* | - | 1st side 10-12 2nd side 9-10 |
| Burger, height 1-2 cm*** | wire rack | 4 |  | 290* | - | 1st side 7-9 2nd side 5-7 |
| Sausages, thickness 2-4cm**** | wire rack | 4 |  | 290* | - | 10-15 |
| Roast joint | wire rack | 2 |  | 180-200 | - | 35+40 |
| Loin joint | wire rack | 2 |  | 180-200 | - | 30+30 |
| Belly | wire rack | 2 |  | 220-240 | - | 25+40 |
| Belly, 1 kg | wire rack | 2 |  | 170-180 190-200 | 1 - | 50-60 25-35 |
| Gammon joint | wire rack | 2 |  | 180-200 | - | 30+25 |
| Poultry | | | | | | |
| Chicken drumstick, 150 g each | wire rack | 3 |  | 210-230 | - | 20-30 |
| Chicken drumstick, 150 g each | wire rack | 3 |  | 210-220 | 2 | 30-40 |
| Chicken breast, boneless, 150 g each*** | wire rack | 4 |  | 275* | - | 1st side 10-15 2nd side 10-15 |
| Chicken breast, boneless, 150 g each | wire rack | 3 |  | 200-210 | 2 | 20-30 |
| Chicken, whole | wire rack | 2 |  | 200-220 | - | 20+15 |
| Chicken, whole, 1,5 kg | wire rack | 2 |  | 180-190 | 2 | 65-75 |
| Chicken, portion, 200-250 g each | wire rack | 3 |  | 210-230 | - | 1st side 15-20 2nd side 10-15 |
| Chicken, portion, 200-250 g each | wire rack | 3 |  | 200-210 | 2 | 35-45 |
| Chicken, quarter 450 g each | wire rack | 2 |  | 210-230 | - | 1st side 20-25 2nd side 15-20 |
| Chicken, quarter 450 g each | wire rack | 3 |  | 190-200 | 2 | 45-55 |
| Duck, 2-3 kg | wire rack | 2 |  | 190-210 | - | 20+20 |
| Duck, 2-3 kg | wire rack | 2 |  | 150-160 | 2 | 100-120 |
| Turkey, crown | wire rack | 2 |  | 190-210 | - | 20+10 |

* Preheat

** Do not preheat

*** Preheat 3 minutes

**** Preheat 3 minutes, turn over several times

| Dish | Accessories | Shelf position | Type of heating | Temperature in °C | Steam intensity | Cooking time in mins. |
|---|-------------|----------------|--|-------------------|-----------------|-----------------------|
| Turkey, drumstick | wire rack | 2 |  | 190-210 | - | 25+20 |
| Turkey, whole, 3-4 kg | wire rack | 2 |  | 160-180 | - | 15+10 |
| Turkey, whole, 4,5-12 kg | wire rack | 2 |  | 140-160 | - | 12+12 |
| Turkey, whole, 4,5-8 kg | wire rack | 1 |  | 140-150 | 2 | 120-150 |
| | | | | 170-180 | - | 30-40 |
| Fish | | | | | | |
| Trout, whole, 300 g each | wire rack | 2 |  | 170-190 | - | 20-30 |
| Fillets, each 150 g*** | wire rack | 4 |  | 220* | - | 1st side 5-10 |
| | | | | | | 2nd side 5-10 |
| Toast | | | | | | |
| Grilling white bread** | wire rack | 4 |  | 290 | - | 4-6 |
| * Preheat | | | | | | |
| ** Do not preheat | | | | | | |
| *** Preheat 3 minutes | | | | | | |
| **** Preheat 3 minutes, turn over several times | | | | | | |

Convenience products

Here, you can find the ideal settings for preparing chilled and frozen food.

Only use original accessories supplied with your appliance. These have been tailored to the cooking compartment and the operating modes of your appliance.

Tips

- The cooking result greatly depends on the quality of the food. Pre-browning and unevenness may already be present on the packaged product.
- Do not use frozen products that are heavily frosted. Remove any ice on the food.
- Distribute foods which are in pieces, such as bread rolls and potato products, so that they are spread flat and evenly on the accessories. Leave a little space between the individual pieces.
- Observe the instructions on the packaging.

Steam- assisted baking

Certain types of baked item (e.g. yeast-risen pastries) get a more crispy crust and a more glossy surface if baked with the steam assist mode. The baked item does not dry out as much.

Steam-assisted baking is only possible on one level.

Shelf positions

Use the indicated shelf positions.

Baking on one level

When baking on one level, use the following shelf positions:

- Tall baked items: Level 2
- Flat baked items: Level 3

If you are using CircoTherm Hot air as the type of heating, you can choose between levels 1, 2, 3 and 4.

Baking on two levels

Use CircoTherm. Baked items that are placed into the oven on trays or in baking tins/dishes at the same time will not necessarily be ready at the same time.

- Universal pan: Level 3
Baking tray: Level 1

Accessories

Ensure that you always use suitable accessories and that they are placed in the oven the right way around.

Wire rack

Insert the wire rack with the open side facing the appliance door and the outer rail pointing downwards .

Universal pan or baking tray

Slide the universal pan or the baking tray in carefully as far as the limit stop with the bevelled edge facing the appliance door.

Greaseproof paper

Only use greaseproof paper that is suitable for the selected temperature. Always cut greaseproof paper to size.

Recommended setting values

In the table, you can find the ideal heating type for various dishes. Temperature and cooking time depend on the quantity and composition of the product. Setting ranges are indicated for this reason. Try using the lower values at first. A lower temperature results in more even browning. You can use a higher setting next time if necessary.





Note: Cooking times cannot be reduced by using higher temperatures. The dish would only be cooked on the outside, but would not be fully cooked in the middle.

The setting values apply to dishes placed into a cold cooking compartment. By doing so, you can make energy savings of up to 20 per cent. If you preheat the oven, the indicated cooking times will be reduced by several minutes.

Preheating is necessary for selected dishes, and this is indicated in the table.

























Remove unused accessories from the cooking compartment. This will achieve the best possible cooking results and energy savings of up to 20 per cent.

Types of heating used:

-  CircoTherm hot air
-  Top/bottom heating
-  Pizza setting
-  Bread baking setting

The levels of steam intensity are indicated as numbers in the table:

- 1 = Low
- 2 = Medium
- 3 = High

| Dish | Accessories/cookware | Shelf position | Type of heating | Temperature in °C | Steam intensity | Cooking time in mins. |
|--------------------------------------|-----------------------------|----------------|---|-------------------|-----------------|-----------------------|
| Pizza, chilled | | | | | | |
| Pizza, chilled | wire rack | 3 |  | 190-210 | - | 10-15 |
| Pizza, frozen | | | | | | |
| Pizza, thin base | wire rack | 3 |  | 190-210 | - | 15-20 |
| Pizza, thin base, 2 levels | universal pan + wire rack | 3+1 |  | 190-210 | - | 20-25 |
| Pizza, thick base | wire rack | 3 |  | 180-200 | - | 20-25 |
| Pizza, thick base, 2 levels | universal pan + wire rack | 3+1 |  | 190-210 | - | 20-30 |
| Pizza baguette | wire rack | 3 |  | 200-220 | - | 15-20 |
| Potatoe products, frozen | | | | | | |
| Oven chips | universal pan | 3 |  | 190-210 | - | 25-35 |
| Oven chips, 2 levels | universal pan + baking tray | 3+1 |  | 190-210 | - | 30-40 |
| Croquettes | universal pan | 3 |  | 200-220 | - | 25-35 |
| Hash browns | universal pan | 3 |  | 200-220 | - | 25-35 |
| Potatoe wedges | universal pan | 3 |  | 190-210 | - | 25-35 |
| Baked goods, frozen, prebaked | | | | | | |
| Rolls, baguettes | universal pan | 3 |  | 180-200 | - | 10-15 |
| Rolls, baguettes | universal pan | 3 |  | 180-200 | 1 | 15-25 |
| White bread | universal pan | 3 |  | 180-200 | - | 15-30 |
| Fried food, frozen | | | | | | |
| Fish fingers* | universal pan | 3 |  | 200-220 | - | 20-30 |
| Chicken nuggets | universal pan | 3 |  | 190-210 | - | 20-25 |
| Food, chilled | | | | | | |
| Lasagna, 400 g | ovenproof dish on wire rack | 2 |  | 190-210 | - | 30-35 |
| Lasagna, 400 g | ovenproof dish on wire rack | 2 |  | 180-190 | 2 | 30-40 |
| Lasagna, 1,2 kg | ovenproof dish on wire rack | 2 |  | 180-200 | - | 30-40 |
| Lasagna, 1,2 kg | ovenproof dish on wire rack | 2 |  | 160-170 | 2 | 35-45 |
| Food, frozen | | | | | | |
| Lasagna, 400 g | ovenproof dish on wire rack | 2 |  | 190-210 | - | 30-35 |
| Lasagna, 400 g | ovenproof dish on wire rack | 2 |  | 180-190 | 2 | 40-50 |
| Lasagna, 1,2 kg | ovenproof dish on wire rack | 2 |  | 180-200 | - | 50-70 |
| Lasagna, 1,2 kg | ovenproof dish on wire rack | 2 |  | 160-170 | 2 | 45-55 |

* Turn during cooking

Yogurt

You can make your own yogurt using your appliance.

Preparing yogurt

Remove accessories and shelves from the cooking compartment. The cooking compartment must be empty.

1. Heat 1 litre of milk (3.5 % fat) to 90 °C on the hob and then cool down to 40 °C.
It is sufficient to heat UHT milk to 40 °C.
2. Stir in 150 g (chilled) yogurt.
3. Pour into cups or small jars and cover with cling film.
4. Place the cups or jars onto the cooking compartment floor and use the settings indicated in the table.
5. After preparation, leave the yogurt to cool in the refrigerator.

Type of heating used:

-  Dough proving

| Dish | Cookware | Shelf position | Type of heating | Dough proving setting | Cooking time in hours |
|---------|-------------------|---------------------------|---|-----------------------|-----------------------|
| Yoghurt | individual moulds | cooking compartment floor |  | 1 | 5-6 |

Save energy with Eco heating types

You can save energy when cooking using the energy-efficient heating types "CircoTherm Eco" and "Top/bottom heating Eco".

Place the food into the empty cooking compartment before it has heated up. Otherwise, energy optimisation will not have any effect. Always keep the appliance door closed when cooking.

Remove unused accessories from the cooking compartment. This will allow you to achieve ideal cooking results and save energy.

Only use original accessories supplied with your appliance. These have been tailored to the cooking compartment and the operating modes of your appliance.

Accessories

Ensure that you always use suitable accessories and that they are placed in the oven the right way around.

Wire rack

Insert the wire rack with the open side facing the appliance door and the outer rail pointing downwards .

Universal pan or baking tray

Slide the universal pan or the baking tray in carefully as far as the limit stop with the bevelled edge facing the appliance door.

Baking tins and cookware

Dark- coloured metal baking tins are most suitable. These allow you to make energy savings of up to 35 per cent.

Cookware made from stainless steel or aluminium reflects heat like a mirror. Non-reflective cookware made from enamel, heat-resistant glass or coated, die-cast aluminium is more suitable.

Tinplate baking tins, ceramic dishes or glass dishes prolong baking time, and the cake will not brown so evenly.

Greaseproof paper



Only use greaseproof paper that is suitable for the selected temperature. Always cut greaseproof paper to size.



Recommended setting values













Here, you can find specifications for the various dishes with CircoTherm Eco and Top/bottom heating Eco. The temperature and baking time depend on the consistency and amount of the dough. Settings ranges are indicated for this reason. Try with the lower values first. A lower temperature results in more even browning. You can increase the temperature next time if necessary.

Note: Baking times can not be reduced by using higher temperatures. Cakes or baked items would only be cooked on the outside, but would not be fully cooked in the middle.

Types of heating used:

-  CircoTherm Eco
-  Top/bottom heating Eco

| Dish | Accessories/cookware | Shelf position | Type of heating | Temperature in °C | Cooking time in mins. |
|-------------------------------|----------------------------|----------------|---|-------------------|-----------------------|
| Baking | | | | | |
| Victoria Sponge Cake | 2x Ø20 cm tins | 2 |  | 170-180 | 30-40 |
| Light Fruit Cake | high Ø20 cm tin | 2 |  | 150-170 | 70-90 |
| Rich Fruit Cake | high Ø23 cm tin | 2 |  | 140-160 | 120-180 |
| Fruit crumble | flat glass dish | 3 |  | 160-180 | 40-70 |
| Sponge Cake (fatless), 3 eggs | springform cake tin Ø26 cm | 2 |  | 160-170 | 25-40 |
| Swiss Roll | swiss roll tin | 3 |  | 180-190 | 15-25 |
| Tart | plate Ø20 cm or pie tin | 2 |  | 170-190 | 55-70 |

| Dish | Accessories/cookware | Shelf position | Type of heating | Temperature in °C | Cooking time in mins. |
|--|---------------------------------|----------------|---|-------------------|-----------------------|
| Quiche | quiche tin (dark coated) | 3 |  | 190-210 | 35-45 |
| (White) Bread | loaf tin (1x 900 g or 2x 450 g) | 2 |  | 190-200 | 40-50 |
| Scones | baking tray | 3 |  | 190-210 | 15-20 |
| Jam tarts | 12-cup-tin | 3 |  | 180-200 | 20-30 |
| Soufflé | 1,2L-soufflé dish | 2 |  | 160-170 | 40-50 |
| Pie | rectangular pie tin | 2 |  | 190-200 | 40-55 |
| Jacket Potatoes | baking tray | 3 |  | 150-170 | 60-90 |
| Meat | | | | | |
| Beef, slow roast joint | wire rack | 2 |  | 130-140 | 40+40 |
| Casserole | | | | | |
| Diced meat (beef, pork, lamb) | cookware, covered | 2 |  | 140 | 60+120 |
| Braising steak | cookware, covered | 2 |  | 140 | 65+120 |
| Fish | | | | | |
| Fish, braised, whole 300 g, e. g. trout | cookware, covered | 2 |  | 190-210 | 25-35 |
| Fish, braised, whole 1,5kg, e. g. salmon | cookware, covered | 2 |  | 190-210 | 45-55 |
| Fish fillet, plain, braised, 100 g | cookware, covered | 2 |  | 190-210 | 15-25 |

Acrylamide in foodstuffs

Acrylamide is mainly produced in grain and potato products prepared at high temperatures, such as potato crisps, chips, sliced bread, bread rolls, bread or fine baked goods (biscuits, gingerbread, spiced biscuit).

| Tips for keeping acrylamide to a minimum | |
|--|---|
| General | <ul style="list-style-type: none"> ■ Keep cooking times as short as possible. ■ Cook food until it is golden brown, but not too dark. ■ Large, thick pieces of food contain less acrylamide. |
| Baking | With top/bottom heating at max. 200 °C. With hot air at max. 180 °C. |
| Biscuits | With top/bottom heating at max. 190 °C. With hot air at max. 170 °C. Egg or egg yolk reduces the production of acrylamide. |
| Oven chips | Spread out a single layer evenly on the baking tray. Cook at least 400 g at once on a baking tray so that the chips do not dry out. |

Slow cook

Slow cooking is a technique for cooking food over a long period at low temperatures. For this reason, it is also called "low-temperature cooking".

Slow cooking is ideal for all prime cuts (e.g. tender portions of beef, veal, pork, lamb or poultry) which are to be cooked "à point". The meat will remain succulent and tender.

The benefit of this cooking method is that it allows lots of scope for menu planning because slow-cooked meat is easy to keep warm. You do not have to turn the meat when cooking. Keep the appliance door closed in order to maintain an even cooking climate.

Only use fresh, clean and hygienic meat without bones. Carefully remove sinews and fat from around the edge. Fat develops a strong, distinct flavour during slow cooking. You can also use seasoned or marinated meat. Do not use defrosted meat.

Meat can be carved immediately following slow cooking. No standing time is required. Due to the special cooking method, the meat looks pink, but is not raw or undercooked.

Note: Delayed-start operation with an end time is not possible for the slow cooking heating type.

Cookware

Use shallow cookware, e.g. a glass/porcelain serving dish. Place the cookware into the cooking compartment to preheat it.

Always place the uncovered cookware onto the wire rack at level 2.

You can find additional information in the tips on slow cooking attached to the settings table.

Your appliance features the heating type "Slow cook". Only start operation when the cooking compartment has fully cooled down. Allow the cooking compartment to warm up for approx. 15 minutes with the cookware inside.

















Sear the meat on the hotplate at a very high heat and for a sufficiently long time on all sides, even on the ends. Place into the preheated cookware right away. Place the cookware containing the meat into the cooking compartment once again and cook slowly.

Recommended setting values

The slow cooking temperature and cooking time are dependent on the size, thickness and quality of the meat. Different settings ranges are indicated for this reason.

Type of heating used:

-  Slow cooking

| Dish | Cookware | Shelf position | Type of heating | Searing time in mins. | Temperature in °C | Cooking time in mins. |
|---|---------------------|----------------|---|-----------------------|-------------------|-----------------------|
| Poultry | | | | | | |
| Duck breast, 400 g | Cookware, uncovered | 2 |  | 6-8 | 90* | 45-60 |
| Chicken breast fillet, 200 g each | Cookware, uncovered | 2 |  | 5-7 | 90* | 30-60 |
| Turkey breast, boned, 1 kg | Cookware, uncovered | 2 |  | 8-10 | 90* | 150-210 |
| Pork | | | | | | |
| Pork tenderloin steak, 5-6 cm thick, 1.5 kg | Cookware, uncovered | 2 |  | 8-10 | 80* | 210-240 |
| Pork fillet, whole | Cookware, uncovered | 2 |  | 6-8 | 80* | 90-120 |
| Pork medallions, 4 cm thick | Cookware, uncovered | 2 |  | 5-7 | 80* | 90-120 |
| Beef | | | | | | |
| Joint of beef (rump), 6-7 cm thick, 1.5 kg | Cookware, uncovered | 2 |  | 8-10 | 80* | 210-270 |
| Beef tenderloin, whole, 1 kg | Cookware, uncovered | 2 |  | 4-6 | 80* | 150-210 |
| Sirloin, 5-6 cm thick | Cookware, uncovered | 2 |  | 6-8 | 80* | 210-270 |
| Beef medallions/rump steak, 4 cm thick | Cookware, uncovered | 2 |  | 5-7 | 80* | 30-60 |
| Veal | | | | | | |
| Joint of veal, 4-5 cm thick, 1.5 kg | Cookware, uncovered | 2 |  | 8-10 | 80* | 210-240 |
| Joint of veal, 10-15 cm thick, 1.5 kg | Cookware, uncovered | 2 |  | 8-10 | 80* | 210-240 |
| Veal fillet, whole, 800 g | Cookware, uncovered | 2 |  | 5-7 | 80* | 120-150 |
| Veal medallions, 4 cm thick | Cookware, uncovered | 2 |  | 5-7 | 80* | 45-90 |
| Lamb | | | | | | |
| Saddles of lamb, boneless, 200 g each | Cookware, uncovered | 2 |  | 5-7 | 80* | 120-180 |
| Leg of lamb, boned, medium, 1 kg, tied | Cookware, uncovered | 2 |  | 6-8 | 80* | 180-240 |
| * Preheat | | | | | | |

Tips for slow cooking

| | |
|--|---|
| Slow-cooking duck breast. | Place the cold duck breast into a pan and fry the skin side first. After slow cooking, grill for 3 to 5 minutes until crispy. |
| The slow-cooked meat is not as hot as conventionally roasted meat. | So that the roasted meat does not cool so quickly, warm the plates and serve the sauces very hot. |

Drying

You can achieve outstanding drying results with CircoTherm. With this type of preserving, flavourings are concentrated by the dehydration.

Only use unblemished fruit, vegetables and herbs and wash them thoroughly. Line the wire rack with greaseproof paper or parchment paper. Drain the excess water from the fruit and dry it.

If necessary, cut it into equal chunks or thin slices. Place unpeeled fruit onto the dish with the sliced surfaces facing upwards. Ensure that neither fruit nor mushrooms overlap on the wire rack.

Grate vegetables and then blanch them. Allow the blanched vegetables to drain off and distribute them evenly on the wire rack.

Dry herbs on the stem. Position the herbs evenly and slightly heaped on the wire rack.

Use the following shelf positions for drying:

- 1 wire rack: Level 3
- 2 wire racks: Level 3+1

Turn very juicy fruit and vegetables several times. After drying, remove the dried products from the paper immediately.





Recommended setting values

In the table, you can find settings for drying various foodstuffs. The temperature and cooking time are dependent on the type, moisture, ripeness and thickness of the food to be dried. The longer you leave the food to be dried, the better it will be preserved. The thinner the slices are, the quicker the drying process will be and the more aromatic the dried food will remain. Setting ranges are indicated for this reason.

If you wish to dry additional foodstuffs, you should use similar foodstuffs in the table as a reference.

Type of heating used:

-  CircoTherm hot air

| Fruit, vegetables and herbs | Accessories | Type of heating | Temperature in °C | Cooking time in hours |
|--|----------------|---|-------------------|-----------------------|
| Pomes (apple rings, 3 mm thick, 200 g per wire rack) | 1-2 wire racks |  | 80 | 5-9 |
| Stone fruit (plums) | 1-2 wire racks |  | 80 | 8-10 |
| Root vegetables (carrots), grated, blanched | 1-2 wire racks |  | 80 | 5-8 |
| Sliced mushrooms | 1-2 wire racks |  | 60 | 6-9 |
| Herbs, washed | 1-2 wire racks |  | 60 | 2-6 |

Preserving

You can preserve fruit and vegetables using your appliance.

Warning – Risk of injury!

If the food is preserved incorrectly, the preserving jars may burst. Follow the instructions for preserving.

Jars

Use only clean and undamaged preserving jars. Only use heat-resistant, clean and undamaged rubber rings. Check clips and clamps in advance.

For each preserving process, only use preserving jars that are the same size and contain the same food. In the cooking compartment, you can preserve the contents of a maximum of six ½, 1 or 1½-litre preserving jars at the same time. Do not use jars that are larger or taller than this. The lids could rupture.

Preserving jars must not touch one another in the cooking compartment during the preserving process.

Preparing fruit and vegetables

Only use fruit and vegetables that are in good condition. Wash them thoroughly.

Peel, core and chop fruit and vegetables appropriate to their type and fill the preserving jars with them up to approx. 2 cm below the rim.

Fruit

Fill the preserving jars with the fruit along with a hot, skimmed sugar solution (approx. 400 ml for a 1-litre jar). For one litre of water:

- Approx. 250 g sugar for sweet fruit
- Approx. 500 g sugar for sour fruit

Vegetables

Fill the jars with the vegetables along with hot, boiled water.

Wipe the rims of the jars, as they must be clean. Place a damp rubber ring and a lid on each jar. Seal the jars with clamps. Place the jars into the universal pan so that they do not touch each other. Pour 500 ml hot water (approx. 80 °C) into the universal pan. Use the settings indicated in the table.

Ending the preserving process

Fruit

After a short while, small bubbles will form at short intervals. Switch off the appliance once all preserving jars are bubbling. Remove the jars from the cooking compartment after the indicated cooling time.

Vegetables

After a short while, small bubbles will form at short intervals. As soon as all preserving jars are bubbling, reduce the temperature to 120 °C and allow the jars to continue to bubble in the closed cooking compartment as indicated in the table. After this time has elapsed, switch off the appliance and make use of the residual heat for several minutes as indicated in the table.





After preserving, remove the jars from the cooking compartment and place them onto a clean cloth. Do not place these hot jars onto a cold or damp surface, as they may crack. Cover the preserving jars to protect them from draughts. Only remove the clamps once the jars are cold.

Recommended setting values

The indicated times in the settings table are average values for preserving fruit and vegetables. They may be influenced by room temperature, the number of jars, quantity, heat and quality of the jar contents. The specifications are based on 1-litre round jars. Before you switch off the appliance or change the cooking mode, check whether the contents of the jars are bubbling as they should. The bubbling process starts after approx. 30-60 minutes.

Type of heating used:

-  CircoTherm hot air

| Preserving | Cookware | Shelf position | Type of heating | Temperature in °C | Cooking time in mins. |
|-------------------------------------|-------------------------|----------------|---|-------------------|----------------------------------|
| Vegetables, e.g. carrots | 1-litre preserving jars | 1 |  | 160-170 | Before it starts bubbling:30-40 |
| | | | | 120 | When it starts to bubble: 30-40 |
| | | | | - | Residual heat: 30 |
| Vegetables, e.g. cucumbers | 1-litre preserving jars | 1 |  | 160-170 | Before it starts bubbling: 30-40 |
| | | | | - | Residual heat: 30 |
| Stone fruit, e.g. cherries, damsons | 1-litre preserving jars | 1 |  | 160-170 | Before it starts bubbling:30-40 |
| | | | | - | Residual heat:35 |
| Pomes, e.g. apples, strawberries | 1-litre preserving jars | 1 |  | 160-170 | Before it starts bubbling:30-40 |
| | | | | - | Residual heat: 25 |

Allowing the dough to prove at dough proving setting

Yeast dough will prove considerably more quickly using the "Dough proving" heating type than at room temperature and does not dry out. Only start operation when the cooking compartment has fully cooled down.

Always allow yeast dough to prove twice. Observe the specifications in the settings tables for the 1st and 2nd proving processes (dough fermentation and final fermentation).

Dough fermentation

Position the dough bowl on the wire rack for the dough fermentation. Use the settings indicated in the table.

Do not open the appliance door during the proving process, as moisture will escape. Do not cover the dough.

Final fermentation

Place your baked item into the oven at the shelf position indicated in the table.





Wipe moisture from the cooking compartment before baking.

Recommended setting values

The temperature and proving time are dependent on the type and quantity of the ingredients. The values in the table are therefore only meant to be average values.

Type of heating used:

-  Dough proving

| Dish | Accessories/cookware | Shelf position | Type of heating | Step | Dough proving | Cooking time in mins. |
|----------------------------|----------------------|----------------|---|--------------------|---------------|-----------------------|
| Yeast dough, sweet | | | | | | |
| E.g. small baked items | Bowl | 2 |  | Dough fermentation | 1 | 30-45 |
| | Universal pan | 2 |  | Final fermentation | 1 | 10-20 |
| Rich dough, e.g. panettone | Bowl | 2 |  | Dough fermentation | 2 | 40-90 |
| | Tin on wire rack | 2 |  | Final fermentation | 2 | 30-60 |

| Dish | Accessories/cookware | Shelf position | Type of heating | Step | Dough proving | Cooking time in mins. |
|-----------------------------|----------------------|----------------|-----------------|--------------------|---------------|-----------------------|
| Yeast dough, savoury | | | | | | |
| E.g. pizza | Bowl | 2 | ☰ | Dough fermentation | 1 | 20-30 |
| | Universal pan | 2 | ☰ | Final fermentation | 1 | 10-15 |
| Bread dough | | | | | | |
| White bread | Bowl | 2 | ☰ | Dough fermentation | 1 | 30-40 |
| | Universal pan | 2 | ☰ | Final fermentation | 1 | 15-25 |
| Multigrain bread | Bowl | 2 | ☰ | Dough fermentation | 1 | 25-40 |
| | Universal pan | 2 | ☰ | Final fermentation | 1 | 10-20 |
| Bread rolls | Bowl | 2 | ☰ | Dough fermentation | 1 | 30-40 |
| | Universal pan | 2 | ☰ | Final fermentation | 1 | 15-25 |

Defrosting

The defrost setting is suitable for defrosting frozen fruit, vegetables and baked items. Poultry, meat and fish should ideally be defrosted in the refrigerator.

Use the following shelf positions when defrosting:

- 1 wire rack: Level 2
- 2 wire racks: Level 3+1

Recommended setting values

The times in the table are average values. They are dependent on the quality, freezing temperature (-18 °C) and composition of the food. Time ranges are indicated. Set the shortest time first and then extend the time if necessary.

Tip: Items which were frozen flat or portioned defrost faster than those frozen in a block.

Remove frozen food from the packaging and place it in suitable cookware onto the wire rack.

Stir the food or turn it once or twice in between. Large pieces of food should be turned several times. Occasionally split the food or remove items which have already defrosted from the cooking compartment.

Leave the defrosted food to rest for another 10 to 30 minutes in the appliance whilst it is switched off, so that the temperature balances out.

Type of heating used:

- ☰ Defrost setting

| Dish | Accessories | Shelf position | Type of heating | Temperature in °C | Cooking time in mins. |
|-----------------------------|-------------|----------------|-----------------|-------------------|-----------------------|
| Bread, bread rolls | | | | | |
| Bread & bread rolls general | Baking tray | 2 | ☰ | 50 | 40-70 |
| Cake | | | | | |
| Cake, moist | Baking tray | 2 | ☰ | 50 | 70-90 |
| Cake, dry | Baking tray | 2 | ☰ | 60 | 60-75 |

Reheating

Using heating type "Reheating", food is reheated gently using steam. It tastes and looks as though it has been freshly prepared. Even baked items from the day before can be re-crisped.

Use containers which are as flat, wide and heat-resistant as possible. Cold containers prolong the reheating process.

Where possible, only reheat dishes of the same size and type at the same time. If this is not possible, the time required for the component with the longest reheating time should be used as a basis.

Do not cover food while it is being reheated.

Place the food in the cookware onto the wire rack or place it directly onto the wire rack at level 2.

Do not open the appliance door during operation, as a lot of steam will escape.

Recommended setting values











In the table, you can find the ideal settings for various dishes. The times specified are only average values. They are dependent on the cookware used, the quality, temperature and consistency of the food. Time ranges are indicated. Set the shortest time first and then extend the time if necessary.

The values in the table apply to dishes placed into a cold cooking compartment. Preheating is necessary for selected dishes, and this is indicated in the table.

Remove unused accessories from the cooking compartment. This will allow you to achieve ideal cooking results and save energy.

Type of heating used:

-  Reheating

| Dish | Accessories/cookware | Shelf position | Type of heating | Temperature in °C | Cooking time in mins. |
|--|----------------------|----------------|---|-------------------|-----------------------|
| Vegetables, chilled | | | | | |
| 1 kg | Cookware, uncovered | 2 |  | 120-130 | 15-25 |
| 250 g | Cookware, uncovered | 2 |  | 120-130 | 5-15 |
| Dishes, chilled | | | | | |
| Plated meal, 1 portion | Cookware, uncovered | 2 |  | 120-130 | 15-25 |
| Soup, stew, 400 ml | Cookware, uncovered | 2 |  | 120-130 | 10-25 |
| Side dishes, e.g. pasta, dumplings, potatoes, rice | Cookware, uncovered | 2 |  | 120-130 | 8-25 |
| Bakes, e.g. lasagne, potato gratin | Cookware, uncovered | 2 |  | 120-140 | 10-25 |
| Pizza, cooked | Wire rack | 2 |  | 170-180* | 5-15 |
| Baked goods | | | | | |
| Bread rolls, baguette, baked | Wire rack | 2 |  | 150-160 | 10-20 |
| Pastries (vol-au-vents) | Wire rack | 2 |  | 180* | 4-10 |
| Baked goods, frozen | | | | | |
| Pizza, cooked | Wire rack | 2 |  | 170-180* | 5-15 |
| Bread rolls, baguette, baked | Wire rack | 2 |  | 160-170* | 10-20 |

* Preheat

Keeping warm

You can keep cooked dishes warm using the "Keeping warm" heating type. This will avoid condensation developing, and means you will not have to wipe out the cooking compartment.

Do not keep cooked dishes warm for longer than two hours. Be aware that some dishes may continue cooking whilst being kept warm. Cover the dishes if necessary.

Test dishes

These tables have been produced for test institutes to facilitate the inspection of the appliance.

In accordance with EN 60350-1:2013 and IEC 60350-1:2011.

Baking

Baked items that are placed into the oven on trays or in baking tins/dishes at the same time will not necessarily be ready at the same time.

Shelf positions for baking on two levels:

- Universal pan: Level 3
Baking tray: Level 1
- Baking tins/dishes on the wire rack
First wire rack: Level 3
Second wire rack: Level 1

Shelf positions for baking on three levels:

- Baking tray: Level 4
- Universal pan: Level 3
- Baking tray: Level 1

Double-crust ed apple pie

Double- crust ed apple pie on one level: place dark- coloured springform cake tins diagonally next to each other.

Double-crust ed apple pie on two levels: position dark- coloured springform cake tins above each other so that they are offset.

Cakes in tinplate springform cake tins: bake on one level with top/bottom heating. Place the springform cake tin onto the universal pan instead of onto the wire rack.



Hot water sponge cake

Hot water sponge cake on two levels: vertically stack springform cake tins in an offset manner on the wire racks.

Notes















- The setting values apply to dishes placed into a cold cooking compartment.
- Please note the information in the tables about preheating. The setting values are valid without rapid heating-up.
- For baking, use the lower of the indicated temperatures first.

Types of heating used:

-  CircoTherm hot air
-  Top/bottom heating
-  Pizza setting

The levels of steam intensity are indicated as numbers in the table:

- 1 = Low
- 2 = Medium
- 3 = High

| Dish | Accessories | Shelf position | Type of heating | Temperature in °C | Steam intensity | Cooking time in mins. |
|---|--------------------------------------|----------------|---|-------------------|-----------------|-----------------------|
| Baking | | | | | | |
| Whirls*** | Baking tray | 3 |  | 140-150* | - | 25-40 |
| Whirls*** | Baking tray | 3 |  | 140-150* | - | 25-40 |
| Whirls, 2 levels*** | Universal pan + baking tray | 3+1 |  | 140-150* | - | 30-40 |
| Whirls, 3 levels*** | Baking trays + universal pan | 4+3+1 |  | 130-140* | - | 35-55 |
| Small cakes*** | Baking tray | 3 |  | 160* | - | 20-30 |
| Small cakes*** | Baking tray | 3 |  | 150* | - | 25-35 |
| Small cakes, 2 levels*** | Universal pan + baking tray | 3+1 |  | 150* | - | 25-35 |
| Small cakes, 3 levels*** | Baking trays + universal pan | 4+3+1 |  | 140* | - | 35-45 |
| Hot water sponge cake** | Springform cake tin, diameter 26 cm | 2 |  | 160-170* | - | 25-35 |
| Hot water sponge cake** | Springform cake tin, diameter 26 cm | 2 |  | 160-170* | - | 25-35 |
| Hot water sponge cake | Springform cake tin, diameter 26 cm | 2 |  | 150-160 | 1 | 10 |
| | | | | | - | 20-25 |
| Hot water sponge cake, 2 levels** | Springform cake tin, diameter 26 cm | 3+1 |  | 150-170* | - | 30-50 |
| Double-crust ed apple pie | 2 x black plate tins, diameter 20 cm | 2 |  | 170-180 | - | 60-80 |
| Double-crust ed apple pie | 2 x black plate tins, diameter 20 cm | 2 |  | 180-200 | - | 60-80 |
| Double-crust ed apple pie, 2 levels | 2 x black plate tins, diameter 20 cm | 3+1 |  | 170-190 | - | 70-90 |
| * Preheat | | | | | | |
| ** Preheat, do not use quick heat function | | | | | | |
| *** Preheat for 5 mins., do not use quick heat function | | | | | | |



en Tested for you in our cooking studio

Grilling

Also slide in the universal pan. The liquid will be caught and the cooking compartment stays cleaner.

Type of heating used:

-  Grill, large area

| Dish | Accessories | Shelf position | Type of heating | Temperature in °C | Cooking time in mins. |
|-------------------------------------|-------------|----------------|---|-------------------|-----------------------|
| Grilling | | | | | |
| Toasting bread* | Wire rack | 4 |  | 290 | 4-6 |
| Beefburgers, x 12** | Wire rack | 4 |  | 290 | 25-30 |
| * Do not preheat | | | | | |
| ** Turn after 2/3 of the total time | | | | | |



A series of horizontal lines spanning the width of the page, providing a structured area for writing or drawing. The lines are evenly spaced and extend across most of the page width.



Lined writing area consisting of 25 horizontal lines spaced evenly down the page.



Constructa Neff
Vertriebs-GmbH
Carl-Wery-Straße 34
D-81739 München

Register your product online

www.neff-international.com



9001037124
950430
en