

## Recommended bulb

1 x 25 Watt energy efficient LED

This product contains a non-replaceable LED module. If the LEDs become damaged then the whole product must be replaced.

When moving or cleaning, always switch off at the mains and allow the LEDs to cool before handling.

## Specifications

Max. power: 25W

Voltage: 240V, 50Hz

IP rating: IP20

Weight: 1.96kg

1600 lumen output

Colour temperature: Warm white (3000K)



Please retain these instructions for future reference.



This symbol  indicates that this product should not be treated as normal household waste and it should be recycled. John Lewis do not operate instore take back, but as members of the Distributor Trade Back scheme have funded the development and upgrade of recycling facilities across the UK. Please take it to your nearest collection facility or for further details contact your local council or visit [www.recycle-more.co.uk](http://www.recycle-more.co.uk).

We have taken great care to ensure that this product reaches you in perfect condition. However, should any parts be damaged or missing please contact the Product Helpline on (01202) 690945.

John Lewis Partnership  
171 Victoria Street  
London SW1E 5NN  
[johnlewis.com](http://johnlewis.com)

Made in China

John Lewis

User manual

Zephyr

Semi flush light

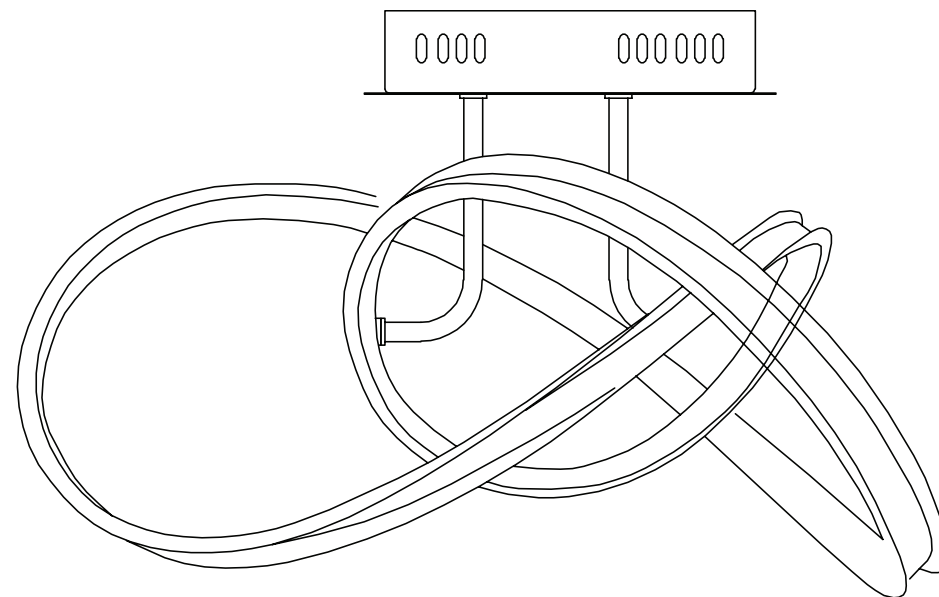

12/06/2019

Thank you for purchasing this Zephyr semi-flush light. Please read the instructions carefully before use to ensure safe and satisfactory operation of this product.

## Warnings!

This is a Class 1 product and must be earthed

For your safety, this product must be installed in accordance with local Building Regulations. If in any doubt, or where required by the law, consult a competent person who is registered with an electrical self-declaration scheme. Further information is available online or from your Local Authority

To prevent electric shock switch off at mains supply before installing or maintaining this fitting. Ensure other persons cannot restore the electrical supply without your knowledge.

This light fitting should be connected to a 5 amp fused circuit.





This product is suitable for installation on surfaces with normal flammability e.g. wood, plasterboard, masonry. It is not suitable for use on highly flammable surfaces (e.g. polystyrene, textiles).

Ensure the correct fixings are used for the installation surface.

For your safety, always switch off the supply before cleaning or adjusting.

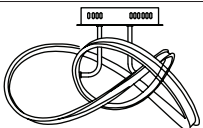
This product is dimmable.

## Parts list

Parts list	Image	Qty
Light Fitting		1
Fixing bracket		1
Screws		2
Wall plugs		2

## Assembly

Refer to assembly drawing opposite. Carefully unpack the carton, making sure all the parts are present before assembly.

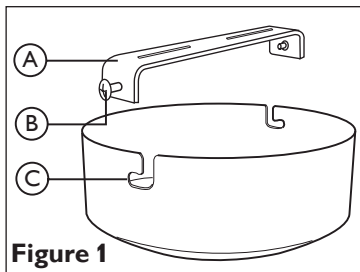

Figure 1

### Step 1

Before removing the existing fitting, **carefully note the position of each set of wires.**

### Step 2

Refer to Figure. 1 Remove the fixing bracket (A) from the ceiling cover by removing the side screws.

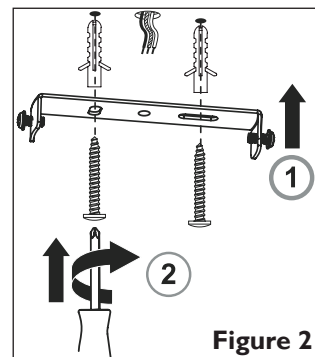
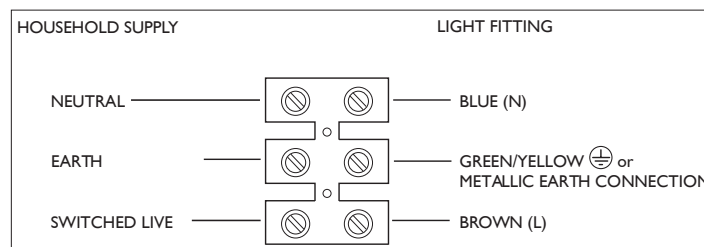

Figure 2

### Step 4

Having identified the household wiring from your existing light fitting, connect to the connection block inside the product as shown. When completed, ensure that there are no bare or loose strands of wire exposed.



### Check that.....

- You have correctly identified the house wires.
- The connections are tight.
- No loose strands have been left out of the connection block.

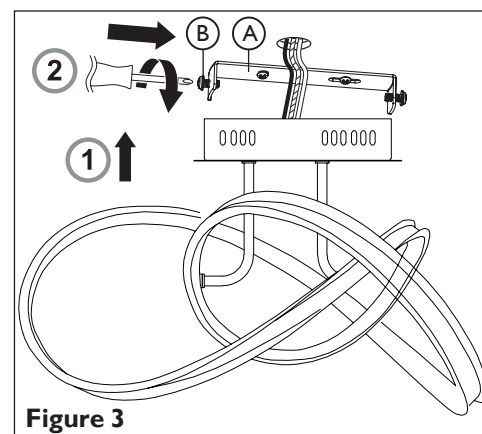

Figure 3

### Step 5

Refer to Figure 3. Attach the product to the ceiling. This product has “L” shaped fixing slots (C) to allow easy attachment to the fixing bracket, as shown in Figure 1. Locate the “L” slots around the small screws (B) on the fixing bracket (A) Rotate the ceiling cover to attach the product to the bracket. Tighten the screws to secure. Take care not to trap any wiring.

### Step 6

Replace fuse or circuit breaker and switch on. Your light is now ready for use.

## Care instructions

We recommend cleaning with a soft dry cloth. Do not use abrasive materials as these will damage the finish.