

Product information

- Indoor use only
- Dimmable - When used with dimmable bulbs
- Replacement bulbs should be the same type and rating, available from John Lewis Partners or other established brands
- Clean the fitting with a soft dry cloth. Do not use abrasive chemical cleaners as this will damage the finish

Aftercare and Troubleshooting

You've switched on the light, but it's not working:

1. Check your power supply is switched on
2. Turn off the light and check that the bulb is inserted correctly
3. Check the bulb is still in working order

If there are technical issues with this product that you can't solve, please contact your nearest John Lewis & Partners shop or call Technical Support on 03301 230106.

Specification

Max power: 4 x 7W
Recommended bulb:
7W LED GU10 bulb
for maximum brightness.
Lower wattages are also suitable.
Rated input: 220 -240V, 50Hz
Bulbs not included
IP rating: 20
Weight: 0.49kg

Fitting a GU10 bulb

Fit bulb pins into round holes.
Then push and twist clockwise
to lock.

Ensure the bulb fitting tool is
clean prior to fitting the bulb.
Any traces of dust can
be wiped away with a
damp cloth.

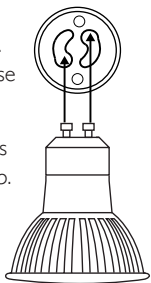

KEELY 4 CEILING BAR USER GUIDE

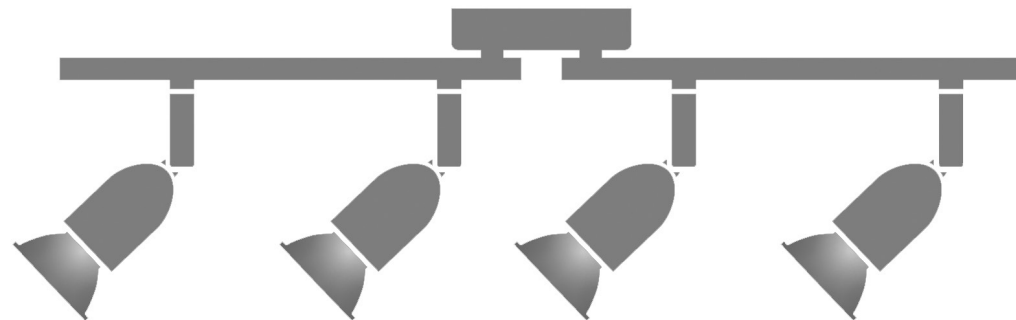

5-year guarantee

At John Lewis & Partners we test every light to high quality standards. That means we can offer you a 5-year guarantee.

Recycling

This symbol  indicates that this product should not be treated as normal household waste and it should be recycled. John Lewis & Partners do not operate instore take back, but as members of the Distributor Take Back scheme have funded the development and upgrade of recycling facilities across the UK. Please take it to your nearest collection facility or for further details contact your local council or visit www.recycle-more.co.uk.

John Lewis plc
SW1V 2QQ
johnlewis.com

Made in China



07/04/2026

Please retain these instructions for future reference.



Product Code:
10522422



Getting started

Thank you for purchasing this John Lewis & Partners product. For your safety, and to make sure everything is working properly, please read the instructions carefully before use.

Warnings

This is a Class 1 product and must be earthed. It is recommended that this fitting is installed by a qualified electrician. Install in accordance with the IEE Wiring regulations and the Building Regulations. To prevent electrocution switch off at mains supply before installing or maintaining this fitting. Ensure other persons cannot restore the electrical supply without your knowledge. If you are in any doubt, please consult a qualified electrician. This light fitting should be connected to a 5 Amp fused circuit. If replacing an existing fitting, make a note of the connections. Always use the correct type and wattage bulb. Never exceed the wattage stated. Dispose of used bulbs carefully. This product is suitable for installation on surfaces with normal flammability e.g. wood, plasterboard, masonry. It is not suitable for use on highly flammable surfaces (e.g. polystyrene, textiles). For your safety, always switch off the supply and allow the fitting to cool down before changing lightbulbs, cleaning or adjusting heads.

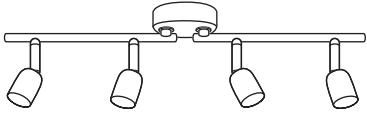
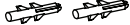
Parts list

Description	Image	Quantity
Light fitting		x 1
Wall plugs		x 2
Screws		x 2

Product assembly

Step 1

Carefully unpack the carton, making sure all the parts are present before assembly. Before removing the existing fitting, carefully note the position of each set of wires.

Folding Bars

This product will be easier to install with the help of an assistant. This product has been designed with folding bars to allow different configurations and layouts to be easily achieved. To position the bars, fold them out into the desired configuration. There is no need to tighten the bars once in position. They are designed to rotate freely to allow easy operation. When installing and using this product, take care not to allow the bars and heads to collide with each other.

Step 2

Remove the fixing bracket (A) from the product by unscrewing the two side screws (B). Retain the screws for reuse later.

Ensure there is a solid mounting surface to support the weight of the light fitting. Using the fixing bracket as a template, mark the position of the mounting holes. Drill holes and fit supplied wall plugs (C) (suitable for masonry only). Take care to avoid damaging any concealed wiring and pipes. Fix the bracket to the ceiling using supplied screws (D).

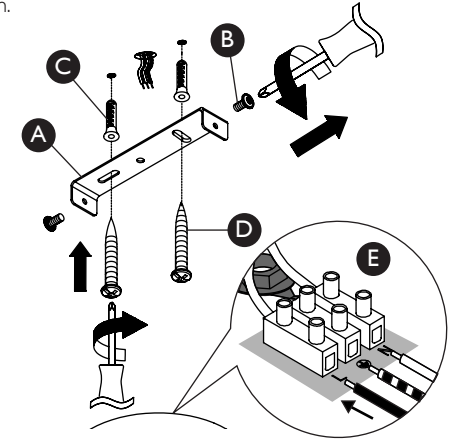

Step 3

Having identified the household wiring from your existing light fitting, connect to the connection block (E) inside the product in the following way. Check that: You have correctly identified the house wires. The connections are tight. No loose strands have been left out of the connection block.

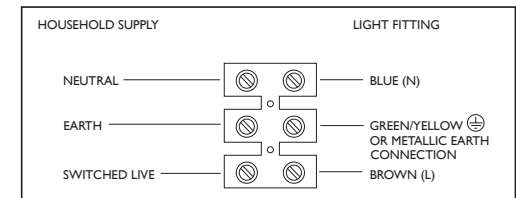

Step 4

Reattach the product to the fixing bracket using the screws removed in step 2. Tighten the screws to secure. Take care not to trap any wiring.

Step 5

Fit the recommended bulbs (F) as per the details overleaf.

Step 6

Your light is now ready for use.

Note:

The angle of the heads can be adjusted to the appropriate angle as needed.

