

Product information

- Indoor use only
- Dimmable - When used with dimmable bulbs
- Replacement bulbs should be the same type and rating, available from John Lewis Partners or other established brands
- Clean the fitting with a soft dry cloth. Do not use abrasive chemical cleaners as this will damage the finish

Aftercare and Troubleshooting

You've switched on the light, but it's not working:

1. Check your power supply is switched on
2. Turn off the light and check that the bulb is inserted correctly
3. Check the bulb is still in working order

If there are technical issues with this product that you can't solve, please contact your nearest John Lewis & Partners shop or call Technical Support on 03301 230106.

Specification

Max power: 3 x 3W
Bulb supplied:
3 x 2.8W LED GU10 bulb
Lower wattages are also suitable.
Rated input: 220 -240V, 50Hz
Bulbs included
IP rating: 20
Weight: 0.95kg

Fitting a GU10 bulb

Fit bulb pins into round holes.
Then push and twist clockwise to lock.

Ensure the bulb fitting tool is clean prior to fitting the bulb.
Any traces of dust can be wiped away with a damp cloth.

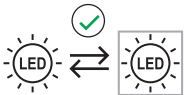
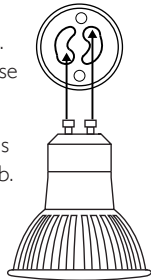

Replaceable (LED only) light source by an end-user

5-year guarantee

At John Lewis & Partners we test every light to high quality standards. That means we can offer you a 5-year guarantee.

Recycling

This symbol  indicates that this product should not be treated as normal household waste and it should be recycled. John Lewis & Partners do not operate instore take back, but as members of the Distributor Take Back scheme have funded the development and upgrade of recycling facilities across the UK. Please take it to your nearest collection facility or for further details contact your local council or visit www.recycle-more.co.uk.

John Lewis plc
SW1V 2QQ
johnlewis.com

Made in China



15/11/2024

Please retain these instructions for future reference.



THEA 3 LIGHT SPOTLIGHT PLATE USER GUIDE



Product Code:
10522323

Thank you for purchasing this Thea 3lt Spotlight Please read the instructions carefully before use to ensure safe and satisfactory operation of this product.

Warnings!

This is a Class 1 product and must be earthed.

Please read these instructions carefully before commencing any work. It is recommended that this fitting is installed by a qualified electrician.

Install in accordance with the IEE Wiring regulations and the Building Regulations.

To prevent electrocution switch off at mains supply before installing or maintaining this fitting.

Ensure other persons cannot restore the electrical supply without your knowledge.

If you are in any doubt, please consult a qualified electrician.

This light fitting should be connected to a 5 amp fused circuit.

If replacing an existing fitting, make a note of the connections.

Always use the correct type and wattage bulb. Never exceed the wattage stated.

When changing a bulb or adjusting the heads, always switch off at the mains and allow to cool down. Dispose of used bulbs carefully.

This product is suitable for indoor use only.



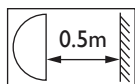

This product is suitable for installation on surfaces with normal flammability e.g. wood, plasterboard, masonry. It is not suitable for use on highly flammable surfaces (e.g. polystyrene, textiles).

For your safety, always switch off the supply before changing lightbulbs, cleaning or removing shades. Always take care when handling lightbulbs to avoid injury in case of breakage.

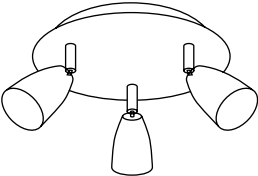

The supplied bulbs are 2.8W LED GU10 and are not dimmable. LED bulbs up to 3W can be used - but ensure that the minimum distance to the illuminated surface is not less than 0.5m (50 cm).

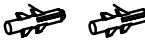
Parts List

Light Fitting		1	Screws		2
			Wall Plugs		2
			Bulb Tool		1
			Bulbs		3

Installation Instructions

Make sure you have the following items which are required to install this light fitting:

- Small electrical screwdriver, cross head screwdriver & insulation tape.
- The installation of this fitting will be much easier with the help of an assistant.

Step 1

Before removing the existing fitting, **carefully note the position of each set of wires.**

Step 2

Remove the fixing bracket (A) from the ceiling cover by loosening the side screws (B). See Fig. 1.

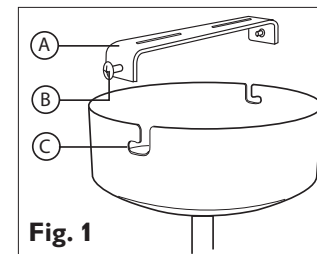

Step 3

Attach to the ceiling using the screws provided. Refer to Fig. 2. Ensure there is a joist at the point of fixing to support the weight of the product. Take care to avoid damaging any concealed wiring and pipes.

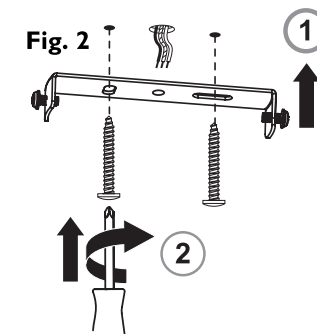

Step 4

Having identified the household wiring from your existing light fitting, connect to the connection block inside the product in the following way:

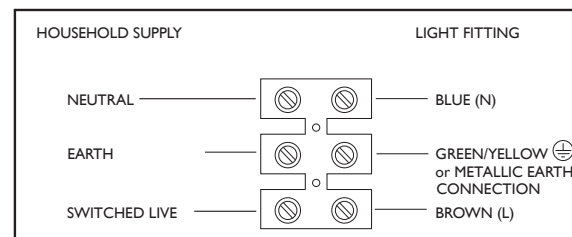

Check that.....

- You have correctly identified the house wires.
- The connections are tight.
- No loose strands have been left out of the connection block.
- The lid is fitted back onto the terminal block case.

Step 5

When completed, ensure that there are no bare or loose strands of wire exposed, and cover all exposed areas of the connection block with 2 layers of insulation tape.

Step 6

This product has “L” shaped fixing slots to allow easy fixing to the ceiling strap. Referring to Fig. 1, locate the “L” slots (C) around the small screws (B) on the ceiling strap (A). Rotate the ceiling cover to attach the product to the strap. Tighten the screws to secure (Fig. 3 - 2). Take care not to trap any wiring.

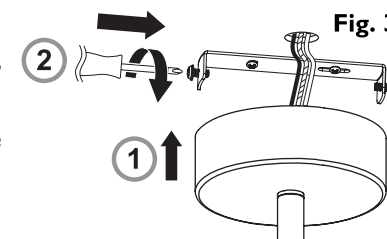

Step 7

Fit the recommended bulbs as per the details below.

Step 8

Replace fuse or circuit breaker and switch on. Your light is now ready for use.