

ILLUMINATED BATHROOM MIRRORS AND CABINETS

2020



JOHN LEWIS
& PARTNERS

WHEN YOU'RE PART OF IT,
YOU PUT YOUR HEART INTO IT

AT JOHN LEWIS & PARTNERS, WE'RE MORE THAN
EMPLOYEES - **WE'RE OWNERS.**

THAT'S WHY WE'RE ALL CALLED PARTNERS.

AND THAT'S WHY WE ALL GO ABOVE AND BEYOND
TO OFFER QUALITY PRODUCTS AND OUTSTANDING
SERVICE TO THE PEOPLE WHO MATTER MOST –
YOU, OUR CUSTOMERS.

BECAUSE FOR US, IT'S PERSONAL

WELCOME

Making the most of your bathroom allows you to create an inspiring space that is much more efficient and a pleasure to use.

The right mirrors and cabinets make all the difference. They give focus to a space and are a beautiful design touch. New technology offers many benefits too: from heated pads that stop mirrors steaming up, to innovative LED lighting that creates different moods and warmth.

Over the following pages we showcase our ranges that have been carefully designed to enhance your space and style.

Download our app or visit johnlewis.com to order.

Introduction	4
Product features	6
Size selection	10
Mirrors	
Halo	14
Aura	16
Frame	18
Pixel	19
Cabinets	
Aspect	20
Wireless sound	22
Enclose	24
Vertical	26
Aerial	27

For your safety, these products should be installed in accordance with local Building Regulations. If in any doubt, or where required by the law, consult a competent person who is registered with an electrical self-certification scheme. Further information is available online or from your Local Authority.

COMPLETING YOUR DREAM BATHROOM



Mirror & Cabinet
Guarantee



INSPIRATION

Whether you're refreshing your bathroom or completely re-designing it, choosing the right mirrors and cabinets are key. It's worth looking for ideas on Pinterest, in interiors magazines or places you visit. You'll also find lots of inspiration and designs in our shops and at johnlewis.com

MIRRORS

The right mirror can create the illusion of space, enhance your lighting scheme and deliver the look you want for your bathroom.

CABINET

New cabinets will give a designer look and feel to your bathroom, while making the most of innovative technology and storage space.



KEY FEATURES THAT MAKES THE DIFFERENCE

COLOUR TEMPERATURE CHANGING LED ILLUMINATION

LED lighting that gives warm and cool light options means you can set your lighting to your mood, the style of your bathroom or the task in hand.

Warm tones are relaxing, while a more natural, white light is perfect when putting on makeup.

A cool white light is bright and sharp, ideal for waking up and getting ready for the day.





USB AND TWO PIN CHARGING SOCKET

A two pin charging socket will power shavers, trimmers and toothbrushes.

A USB socket is ideal to top up the power in your phone or for charging some electric toothbrushes.



HEATED PAD

By warming the area behind the glass, a heated pad helps condensation evaporate. The mirror doesn't steam-up and you always have a clear view.

OUR PRODUCTS

SENSOR SWITCH

Sensor switches are a brilliant hands-free option.

KEEP-CLEAN MATS

Keep-clean mats are mould-resistant and stay fresh.



MIRRORED SIDES

Mirrored side panels on cabinets create a feeling of extra space.



REMOVABLE SHELVES

Removable shelves give more flexibility, making space for taller products.

MIRRORED DOORS

Doors with mirrors on both sides make the best use of space.



RANGE FEATURES

ILLUMINATED MIRROR FEATURES

	HALO	AURA	FRAME	PIXEL
Colour temperature changing LED illumination	•	•		
Charging socket		•*		
Heated pad	•	•	•	
Touch switch	•	•		
Sensor switch			•	
Rocker switch				•
Landscape or portrait	•*	•*	•*	•*

*Not available on all mirrors

ILLUMINATED CABINET FEATURES

	ASPECT	WIRELESS SOUND	ENCLOSE	VERTICAL	AERIAL
Colour temperature changing LED illumination		•	•		
Integrated Charging socket(s)	•	•	•		
USB charging socket(s)	•				
Heated pad	•	•	•		
Touch switch		•			
Sensor switch	•		•	•	•
Soft close hinges			•	•	
Mirrored sides	•			•	
Double sided mirrored door(s)	•		•	•	•
Integrated speakers		•			
Wireless connectivity		•			
Internal illuminated magnifying mirror		•			
Removable "keep clean" mat(s)	•				
Magnetic door closure					•

GETTING PROPORTIONS RIGHT



CHOOSING THE RIGHT SIZE

For a well-balanced design aesthetic, make sure your mirror or cabinet is the same width or narrower than your basin unit, but not wider.

Match to the width of your basin unit to create a contemporary feel. Or go narrower for a more boutique look.

THE RIGHT HEIGHT

The optimum height to hang your mirror or cabinet is 165cm from the centre of the mirror to the floor. This will give the optimum facial reflection at different heights.

WIDTHS CAN CHANGE THE LOOK

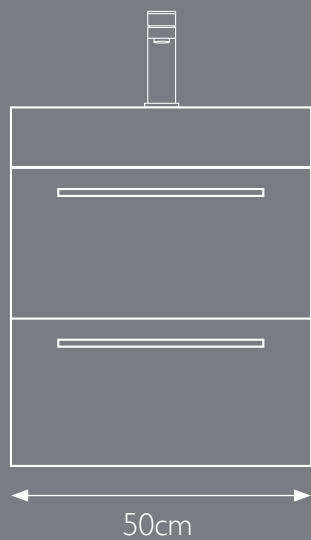
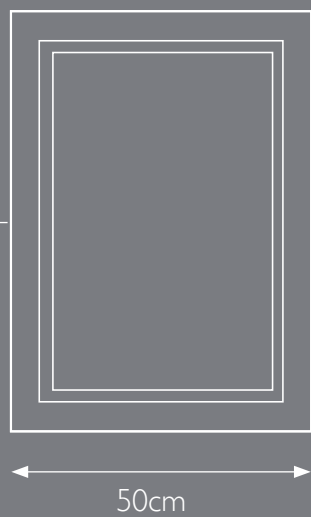

Floor

Centre Line

165cm

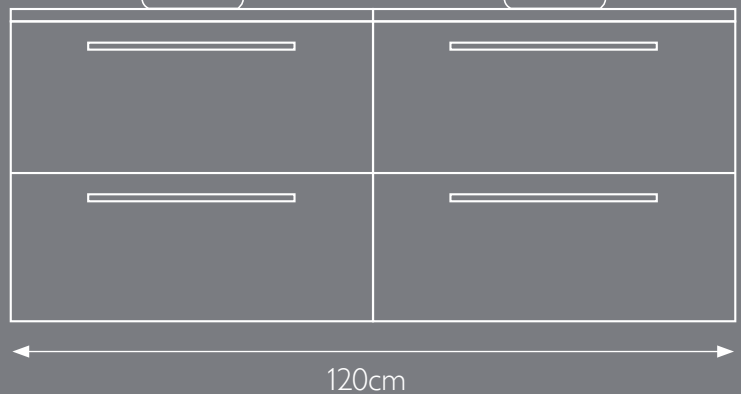
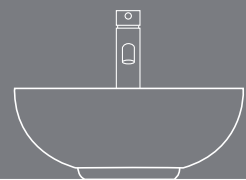
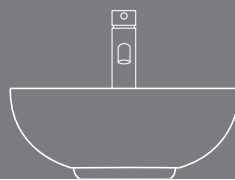
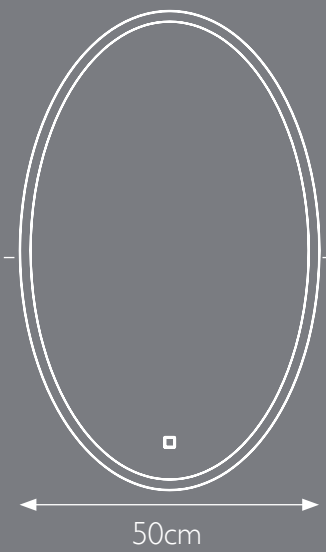
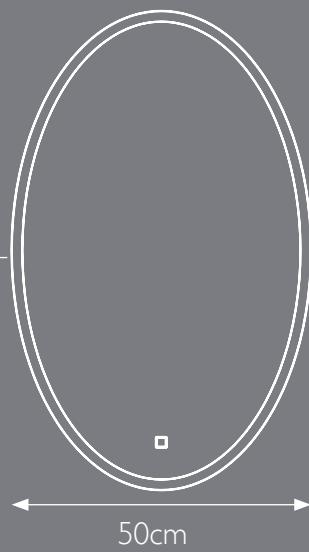



Visit one of our shops and a Partner will talk you through all the cabinets and mirrors we offer. They'll help you decide which will work best for your space.



RANGE GUIDE

HALO

ILLUMINATED MIRRORS

Adjustable lighting transforms the ambience of your bathroom, from soft and relaxing to bright and energising. Halo's white backlight changes from warm to icy-cool at the touch of a button.



Mirror & Cabinet
Guarantee



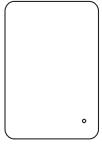

**HALO ILLUMINATED
MIRROR SMALL**

60 x 40cm

84910322

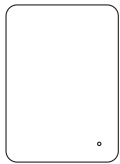

**HALO ILLUMINATED
MIRROR MEDIUM**

70 x 50cm

84910316

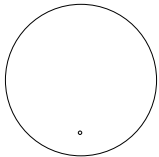

**HALO ILLUMINATED
MIRROR ROUND**

Ø60cm

84910317

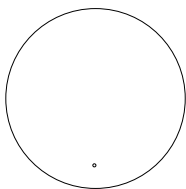

**HALO ILLUMINATED
MIRROR LARGE ROUND**

Ø80cm

84910323

KEY FEATURES

- Colour temperature changing LED illumination
- Heated pad
- Halo small and medium can be hung landscape or portrait
- Touch switch



AURA

ILLUMINATED MIRRORS

Aura features LED colour temperature changing lighting and a charging socket on the small, medium and large mirrors which is discreetly hidden behind the mirror front. The socket is suitable for toothbrushes, shavers and trimmers.

Aura is also fitted with a heated pad to help keep the glass clear.



Mirror & Cabinet
Guarantee



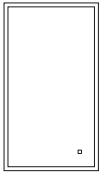

**AURA ILLUMINATED
MIRROR SMALL**

60 x 40cm

84910324

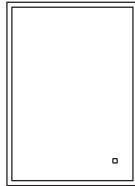

**AURA ILLUMINATED
MIRROR MEDIUM**

70 x 50cm

84910330

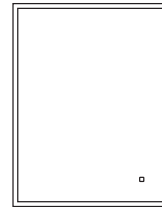

**AURA ILLUMINATED
MIRROR LARGE**

80 x 60cm

84910326

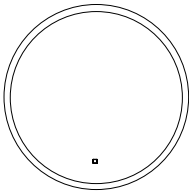

**AURA ILLUMINATED
MIRROR ROUND**

Ø60cm

84910328

No charging socket

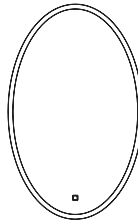

**AURA ILLUMINATED
MIRROR OVAL**

80 x 50cm

84910329

No charging socket



KEY FEATURES

- Colour temperature changing LED illumination
- Charging socket on Aura small, medium and large
- Aura small, medium and large can be hung landscape or portrait
- Heated pad
- Touch switch

FRAME



Mirror & Cabinet
Guarantee



KEY FEATURES

- LED frame illumination
- Frame small and medium can be hung landscape or portrait
- Heated pad
- Sensor switch

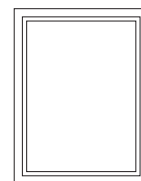

FRAME ILLUMINATED MIRROR SMALL

60 x 40cm
84910314

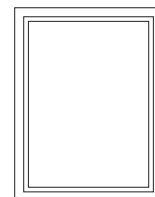

FRAME ILLUMINATED MIRROR MEDIUM

70 x 50cm
84910319

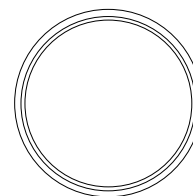

FRAME ILLUMINATED MIRROR ROUND

Ø60cm
84910321

PIXEL



Mirror & Cabinet
Guarantee

KEY FEATURES

- LED dot illumination
- Pixel small and medium can be hung landscape or portrait
- Rocker switch

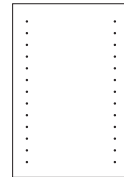

PIXEL ILLUMINATED MIRROR SMALL

60 x 40cm

84910303

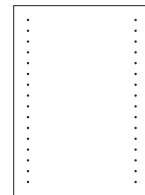

PIXEL ILLUMINATED MIRROR MEDIUM

70 x 50cm

84910307

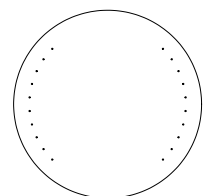

PIXEL ILLUMINATED MIRROR ROUND

Ø60cm

84910311

ASPECT

ILLUMINATED CABINETS

Elegant and practical, our Aspect cabinet is framed with delicate precision lighting to give it definition, while the decorative mirrored profile reflects and complements the surrounding décor. With integrated USB and charging sockets.



Mirror & Cabinet
Guarantee



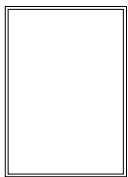

**ASPECT ILLUMINATED
CABINET SINGLE**

70 x 50cm

84901925

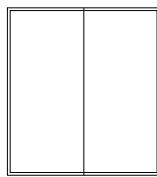

**ASPECT ILLUMINATED
CABINET DOUBLE**

70 x 60cm

84901926

KEY FEATURES

- LED illumination
- Ambient lighting below
- Precision door illumination border
- Integrated charging socket(s)
- USB charging socket(s)
- Double sided mirrored door(s)
- Heated pad in mirrored door(s)
- Mirrored sides
- Sensor switch
- Removable "keep clean" mat(s)

WIRELESS SOUND

ILLUMINATED CABINET

Relax and unwind by connecting your mobile device via wireless internet to this cabinet, and listen to your favourite podcast or playlist during your soak.



Mirror & Cabinet
Guarantee



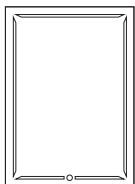

**WIRELESS SOUND
ILLUMINATED CABINET
SINGLE**

70 x 50cm
84901903

KEY FEATURES

- Colour temperature changing LED illumination
- Internal illuminated magnifying mirror
- Integrated speakers
- Wireless connectivity
- Mirrored sides
- Heated pad
- Integrated charging socket
- Touch switch

ENCLOSE

ILLUMINATED CABINETS

With its mirrored doors, Enclose is designed to reflect and radiate light on every surface.

This stunning cabinet gives out ambient light from the top and bottom, while the LED border detail creates more defined lighting on the mirrored doors.

Enclose also has built-in charging points and a heated pad to keep the glass clear.

Soft-close hinges ensure doors close gently and quietly every time.



Mirror & Cabinet
Guarantee



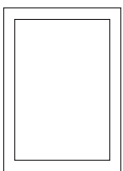

**ENCLOSE ILLUMINATED
CABINET SINGLE**

70 x 50cm
84901923

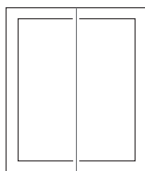

**ENCLOSE ILLUMINATED
CABINET DOUBLE**

70 x 60cm
84901924

KEY FEATURES

- Colour temperature changing LED illumination
- Ambient top and bottom lighting
- Heated pad in the mirrored door(s)
- Integrated charging socket
- Double sided mirrored door(s)
- Soft close hinges
- Sensor switch

VERTICAL



Mirror & Cabinet
Guarantee



ILLUMINATED CABINETS

Vertical's sleek, mirrored exterior is complemented by vertical strips of LED colour temperature changing light. This allows you to set the mood, with cool or warm white illumination.

Inside the cabinet you'll find plenty of storage space and conveniently located charging points for electric razors and toothbrushes.

KEY FEATURES

- LED illumination
- Double sided mirrored door(s)
- Soft close hinges
- Mirrored sides
- Sensor switch



VERTICAL ILLUMINATED CABINET SINGLE

70 x 50cm
84901910

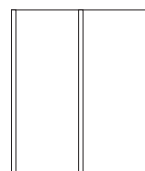

VERTICAL ILLUMINATED CABINET DOUBLE

70 x 60cm
84901921

AERIAL



Mirror & Cabinet
Guarantee

ILLUMINATED CABINETS

Minimalist mirrored cabinets featuring a sensor-activated LED top light. The light gives you perfectly positioned illumination for daily tasks such as shaving and styling your hair.



KEY FEATURES

- LED illumination
- Double sided mirrored door(s)
- Sensor switch
- Magnetic door closure



AERIAL ILLUMINATED CABINET SINGLE

70 x 50cm
84901904

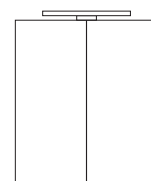

AERIAL ILLUMINATED CABINET DOUBLE

70 x 60cm
84901908

