

# AEG

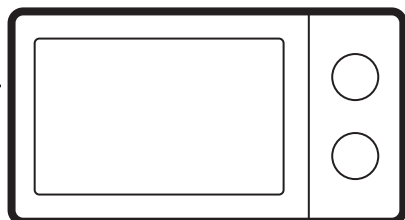

[aeg.com/register](https://aeg.com/register)



MSE2547DBM

## SAFETY INFORMATION

Before the installation and use of the appliance read the supplied instructions carefully. The manufacturer is not responsible for any injuries or damage that result from incorrect installation or usage. Always keep the instructions in a safe and accessible location for future reference.

### Children and vulnerable people safety

#### WARNING!

Risk of suffocation, injury or permanent disability.

- This appliance can be used by children aged from 8 years and above and persons with reduced physical, sensory or mental capabilities or lack of experience and knowledge if they have been given supervision or instruction concerning the use of the appliance in a safe way and understand the hazards involved. Children of less than 8 years of age and persons with very extensive and complex disabilities shall be kept away from the appliance unless continuously supervised.
- Children should be supervised to ensure that they do not play with the appliance.
- Keep all packaging away from children and dispose of it appropriately.
- **WARNING:** The appliance and its accessible parts become hot during use. Keep children and pets away from the appliance when in use and when cooling down.
- If the appliance has a child safety device, it should be activated.
- Children shall not carry out cleaning and user maintenance of the appliance without supervision.

### General Safety

- This appliance is for cooking purposes only.
- This appliance is designed for single household do-

mestic use in an indoor environment.

- This appliance may be used in offices, hotel guest rooms, bed & breakfast guest rooms, farm guest houses, and other similar accommodation where such use does not exceed average domestic usage levels.
- **WARNING:** The appliance and its accessible parts become hot during use. Care should be taken to avoid touching the heating elements.
- **WARNING:** Only a qualified person can carry out any service or repair operation that involves the removal of a cover which gives protection against exposure to microwave energy.
- **WARNING:** If the door or door seals are damaged, the appliance must not be operated until it has been repaired by a qualified person.
- **WARNING:** Do not heat liquids and other foods in sealed containers. They are liable to explode.
- If the mains power supply cable is damaged, it must be replaced by the manu-

facturer, its Authorised Service Centre or similarly qualified persons to avoid an electrical hazard.

- Before any maintenance operation, deactivate the appliance and disconnect the mains plug from the socket.
- Always use oven gloves to remove or insert accessories or ovenware.
- Do not operate the appliance by means of an external timer or separate remote-control system.
- Metallic containers for food and beverages are not allowed during microwave cooking.
- Only use utensils that are suitable for use in microwave ovens.
- When heating food in plastic or paper containers, keep an eye on the appliance due to the possibility of ignition.
- The appliance is intended for heating food and beverages. Drying of food or clothing and heating of warming pads, slippers, sponges, damp cloth and similar may lead to risk of injury, ignition or fire.
- If smoke is emitted, switch off or unplug the appliance

and keep the door closed in order to stifle any flames.

- Microwave heating of beverages can result in delayed eruptive boiling. Care must be taken when handling the container.
- The contents of feeding bottles and baby food jars shall be stirred or shaken and the temperature checked before consumption, in order to avoid burns.
- Eggs in their shell and whole hard-boiled eggs should not be heated in the appliance since they may explode, even after microwave heating has ended.
- Failure to maintain the appliance in a clean condition could lead to deterioration of the surface that could adversely affect the life of

the appliance and possibly result in a hazardous situation.

- The temperature of accessible surfaces may be high when the appliance is operating.
- Do not activate the appliance when it is empty. Metal parts inside the cavity can create electric arcing.
- The appliance should be cleaned regularly and any food deposits removed.
- Do not use a steam cleaner to clean the appliance.
- Do not use harsh abrasive cleaners or sharp metal scrapers to clean the glass door since they can scratch the surface, which may result in shattering of the glass.
- The appliance must be operated with the decorative door open (if applicable).

## SAFETY INSTRUCTIONS

### Installation

#### **WARNING!**

Only a qualified person must install this appliance.

- Remove all the packaging.
- Do not install or use a damaged appliance.
- Follow the installation instructions supplied with the appliance.

- Always take care when moving the appliance as it is heavy. Always use safety gloves and enclosed footwear.
- Do not pull the appliance by the handle.
- Keep the minimum distance from other appliances and units.
- Install the appliance in a safe and suitable place that meets installation requirements.
- The sides of the appliance must stay next to appliances or units with the same height.

## Electrical Connection

### **WARNING!**

Risk of fire and electric shock.

- All electrical connections should be made by a qualified electrician.
- The appliance must be earthed.
- Make sure that the parameters on the rating plate are compatible with the electrical ratings of the mains power supply.
- If the appliance is connected to the socket via an extension cord, make sure the cord is earthed.
- Make sure not to cause damage to the mains plug and to the mains cable. Contact the Service or an electrician to change a damaged mains cable.
- Do not pull the mains cable to disconnect the appliance. Always pull the mains plug.

## Use

### **WARNING!**

Risk of injury, burns and electric shock or explosion.

- Do not change the specification of the appliance.
- Do not let the appliance stay unattended during operation.
- Do not apply pressure on the open door.
- Make sure that the ventilation openings are not blocked.
- Do not use the appliance as a work surface and do not use the cavity for storage purposes.

## Care and Cleaning

### **WARNING!**

Risk of injury, fire, or damage to the appliance.

- Before maintenance, deactivate the appliance and disconnect the mains plug from the mains socket.
- Clean regularly the appliance to prevent the deterioration of the surface material.
- Do not allow food spills or cleaner residue to accumulate on door sealing surfaces.
- Fat and food remaining in the appliance can cause fire and electric arcing when the microwave function operates.
- Clean the appliance with a moist soft cloth. Use only neutral detergents. Do not use abrasive products, abrasive cleaning pads, solvents or metal objects.
- If you use an oven spray, obey the safety instructions on the packaging.

## Service

- To repair the appliance contact the Authorised Service Centre. Use original spare parts only.
- Concerning the lamp(s) inside this product and spare part lamps sold separately: These lamps are intended to withstand extreme physical conditions in household appliances, such as temperature, vibration, humidity, or are intended to signal information about the operational status of the appliance. They are not intended to be used in other applications and are not suitable for household room illumination.

## Disposal

### **WARNING!**

Risk of injury or suffocation.

- Disconnect the appliance from the mains supply.
- Cut off the mains electrical cable close to the appliance and dispose of it.

## INSTALLATION

### **WARNING!**

Refer to Safety chapters.

## General Information

### **CAUTION!**

Do not connect the appliance to adapters or extension leads. This can cause overloading and risk of fire.

### **⚠ CAUTION!**

The minimum installation height is 85 cm.

- The microwave is for built-in use only. It must be placed on a stable and flat surface.
- The cabinet can not have a back wall in the place where the microwave is located.
- Put the microwave far away from steam, hot air and water splashes.
- If the microwave is too close to a radio or TV set it may cause interference in the received signal.
- If you transport the microwave in the cold weather, do not activate it immediately after the installation. Let it stand in the room temperature and absorb the heat.

### **Electrical installation**

This appliance is supplied with a main cable and main plug.

The cable has an earth wire with an earthing plug. The plug must be plugged into an outlet that is properly installed and earthed. In the event of an electrical short circuit, earthing reduces the risk of electric shock.

### **Installing the microwave**

1. Check if the dimensions of the furniture meet the installation distances.
2. Put the template on the bottom of cabinet and check if it fits. If yes, mark the spots for screws. Remove the template and fix the bracket with the screws (A) in the marked spot.
3. Install the microwave. If you fixed the bracket, make sure it locks the back of the appliance.

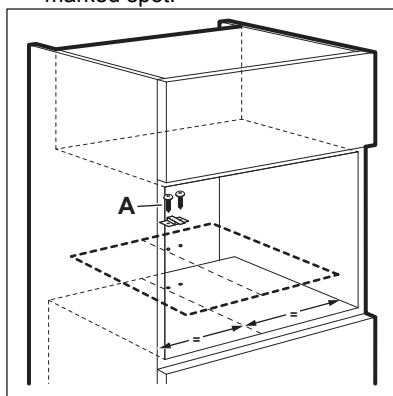
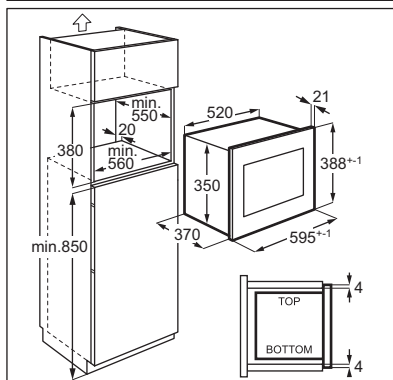
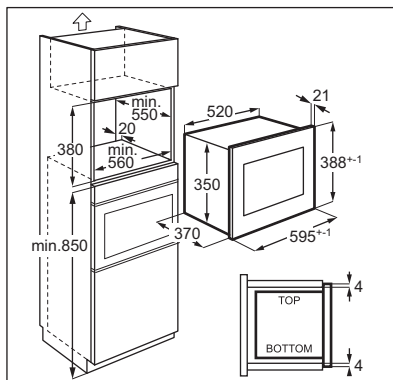

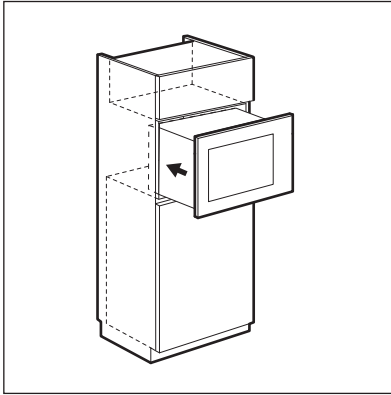

4. Open the door and fix the microwave to the cabinet with a screw (B).

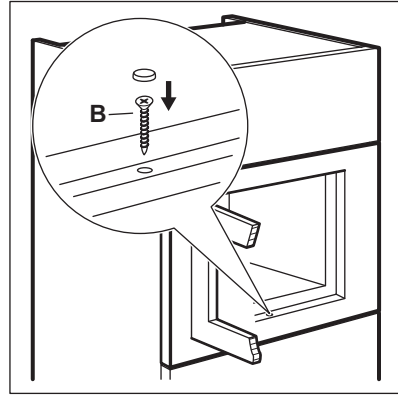

## PRODUCT DESCRIPTION

### General overview

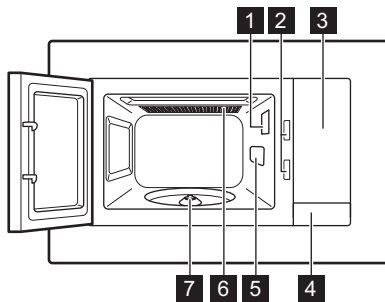





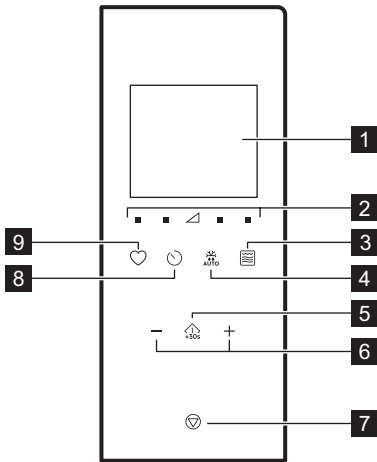

- 1 Lamp
- 2 Safety interlock system
- 3 Control panel
- 4 Door opener
- 5 Waveguide cover
- 6 Grill
- 7 Turntable shaft

**i** This Product fulfils the requirements of the European standard EN55011. In conformity to this standard, this product is classified as group 2 class B equipment. Group 2 means that the equipment intentionally generates radio-frequency energy in the form of electromagnetic radiation for the heat treatment of food. Class B equipment means that the equipment is suitable to be used in domestic establishments.

## Control Panel



Symbol	Function Description
1 —	Display Shows the settings and current time.
2 ■ ▽	Power settings pads Allow to set the microwave power level
3 	Grilling function pad To set the microwave / combi cooking / grill.
4  AUTO	Defrosting To defrost food by weight.
5 	Start / +30 sec To start the appliance or increase the cooking time for 30 seconds at full power.
6 —, +	Setting pads To set the time, weight, temperature or Auto cooking function.

Symbol	Function Description
7 	Stop / Clear To deactivate the appliance or delete the cooking settings.
8 	Clock To set the clock / reminder.
9 	Favourite To quickly choose an automatic function.

## Accessories

### Turntable set

① Always use the turntable set to prepare food in the microwave.

Glass cooking tray and turntable support.

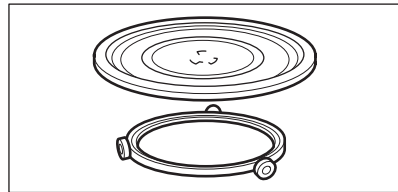

### Grill Rack

- Low grill rack

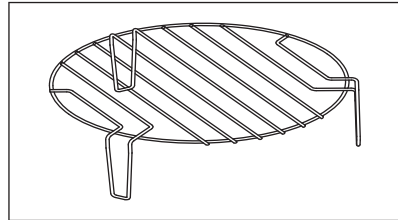

Use for: grilling food with low intensity, convection cooking

## BEFORE FIRST USE

### **WARNING!**

Refer to Safety chapters.

### Removing protective film

Before first use remove the protective film from the frame.

### Initial Cleaning

### **WARNING!**



Refer to "Care and cleaning" chapter.

- Remove all the accessories from the appliance.
- Carefully clean the appliance cavity with a moist soft cloth.

### Preheating

### **WARNING!**

Preheat the empty appliance before first use.

1. Press  repeatedly to set the Grilling function .
2. Let the appliance operate for 30 min to remove odour caused by the manufacturing process.
3. Open the door and let it cool down.
4. Clean the appliance cavity with a moist soft cloth and dry carefully.

The appliance can emit an odour and smoke during the first few uses. This is normal and does not indicate any malfunction. Make sure that the airflow in the room is sufficient.

## DAILY USE

### **WARNING!**

Refer to Safety chapters.

### General information about using the appliance

- After you deactivate the appliance, leave the food for several minutes.
- Remove the aluminium foil packaging, metal containers, etc. before you prepare the food.

### Cooking

- Cook food covered with a material suitable for use in the microwave. Cook food without a cover only if you want to keep it crusty.
- Do not overcook the dishes by choosing too high power settings and too long cooking time. The food can dry out, burn or cause fire.
- Do not use the appliance to cook eggs or snails in their shells as they may explode. With fried eggs, pierce the yolks first.

- Pierce the skin or peel of potatoes, tomatoes, sausages and similar types of food with a fork several times before cooking so that the food does not burst.
- For chilled or frozen food, set a longer cooking time.
- Dishes with sauce must be stirred from time to time.
- Vegetables that have a firm structure, such as carrots, peas or cauliflower, must be cooked in water.
- Turn larger pieces of food halfway through the cooking process.
- If possible, cut vegetables into similar-sized pieces.
- Use flat, wide dishes.
- Do not use cookware made of porcelain, ceramic or earthenware with unglazed bottoms or small openings, for example, on handles. Moisture may get into these openings causing the cookware to crack when heated up.
- The glass cooking tray is necessary for the operation of the microwave. Place the food or liquids on it.

### Defrosting meat, poultry, fish

- Put frozen, unwrapped food on a small angled plate with a container below so that the defrosting liquid collects in the container.
- Turn the food halfway through the defrosting time. If possible, separate and then remove the pieces that started to defrost.

### Defrosting butter, portions of gâteau, quark

- Do not fully defrost the food in the appliance, but let it defrost at room temperature. It gives a more even result. Remove all metal or aluminium packaging before defrosting.

### Suitable cookware and materials

### Defrosting fruit, vegetables

- If fruit and vegetables should remain raw, do not defrost them fully in the appliance. Let them defrost at room temperature.
- To cook fruit and vegetables without defrosting them first use a higher microwave power.

### Ready meals

- You can prepare ready meals in the appliance only if their packaging is suitable for microwave use.
- You must follow the manufacturer's instructions printed on the packaging (e.g. remove the metal cover and pierce the plastic film).

Cookware / Material	Microwave			Grilling
	Defrosting	Heating	Cooking	
Ovenproof glass and porcelain with no metal components, e. g. Pyrex, heat-proof glass	✓	✓	✓	✓
Non-ovenproof glass and porcelain <sup>1)</sup>	✓	x	x	x
Glass and glass ceramic made of ovenproof/frost-proof material (e. g. Arcoflam), grill shelf	✓	✓	✓	✓
Ceramic <sup>2)</sup> , earthenware <sup>2)</sup>	✓	✓	✓	x
Heat-resistant plastic up to 200 °C <sup>3)</sup>	✓	✓	✓	x
Cardboard, paper	✓	x	x	x
Clingfilm	✓	x	x	x
Roasting film with microwave safe closure <sup>3)</sup>	✓	✓	✓	x
Roasting dishes made of metal, e. g. enamel, cast iron	x	x	x	✓
Baking tins, black lacquer or silicon-coated <sup>3)</sup>	x	x	x	✓
Baking tray	x	x	x	✓
Browning cookware, e. g. crisp pan or crunch plate	x	✓	✓	x
Ready meals in packaging <sup>3)</sup>	✓	✓	✓	✓

<sup>1)</sup> With no silver, gold, platinum or metal plating / decorations

<sup>2)</sup> Without quartz or metal components, or glazes which contain metals

<sup>3)</sup> You must follow the manufacturer's instructions about the maximum temperatures.

✓ suitable

x not suitable

## Activating and deactivating the microwave

### ⚠ CAUTION!

Do not let the microwave operate if there is no food in it.

1. Press or to set the power level. To choose the appropriate level see the table below.
2. Press or to set the cooking time.
3. Press to confirm and activate the microwave.

## Power setting tables

### Microwave

Microwave power	Low	Med. low	Med.	Med. high	High
Display	100 Watt	300 Watt	500 Watt	700 Watt	900 Watt

### Grill and Combi cooking

Press	Display	Power setting
		Grill 100%
1 time		Grill 100%
2 times		Microwave 36% Grill 64%
3 times		Microwave 55% Grill 45%
4 times	<b>900 WATT</b>	Microwave 100%

### Quick Start

**i** The maximum cooking time is 95 minutes.

You can quickly activate the microwave in the following ways.

- Press to activate the microwave for 30 seconds at full power. The cooking time increases by 30 seconds with each additional press of the button.

To cancel the settings press .

To deactivate the microwave:

- wait until the microwave deactivates automatically, when the time comes to an end. The display shows 0:00.
- open the door. The microwave stops automatically. Close the door and press to continue to cook. Use this option to inspect food.
- press .

**i** When the microwave deactivates automatically, an acoustic signal sounds.

- Press once. Set the cooking time with the Setting pads. Press to activate the microwave at full power.

## Grilling and Combi Cooking

Refer to Power setting tables.



1. Press repeatedly to set the Grilling or Combi Cooking function.
2. Press the Setting pads to set the time.
3. Press to confirm and activate the microwave.



**i** An acoustic signal sounds after half of the cooking time passes. You can turn over the food.

## Defrosting

1. Press again and again to choose a type of food.

Symbol	Function
	Defrost bread
	Defrost meat







Symbol	Function
	Defrost fish
	Defrost vegetable

- Press  and  to set the weight. The time is set automatically.
- Press  to confirm and activate the microwave.

## Multistage cooking

You can set the appliance to run functions sequentially. Cooking can be done in up to three stages, and if one of them is defrosting, it must be set as the first stage.

Example: Defrost and Microwave:

- Press  and choose the food.
- Press  or  to select the weight.
- Press  or  to set the power level.
- Press  or  to set the cooking time.

In order to set third stage, repeat steps 3 and 4.

- Press  to confirm.

The display counts down the time. When you hear an acoustic signal during the defrosting mode, turn over or rearrange the food.



## Favourite

You can save 3 Favourite settings.

Use this function to save a setting that you often use with the microwave.



- Set the function and parameters you want to save.

Refer to the procedure for the function you want to set.

- Press  and hold for 2 seconds. An acoustic signal sounds.
- Press  to confirm and save.

You can modify saved favourites. Press  and change the function or parameters using the same procedure.

## Using the Favourite programme

- In standby mode press  repeatedly to choose setting 1, 2 or 3.
- Press  to activate the microwave.

## Favourite Menu

Dish	Weight	Display
Softening butter	50 g	50 g
	100 g	100 g
	150 g	150 g
	200 g	200 g
	250 g	250 g
Melting chocolate	100 g	100 g
	150 g	150 g
	200 g	200 g
Mud Cake	1 cup	1
	2 cups	2
	3 cups	3
	4 cups	4

## USING THE ACCESSORIES

### WARNING!

Refer to Safety chapters.

## Inserting the turntable set

### CAUTION!

Do not cook food without the turntable set. Use only the turntable set provided with the microwave.

 Never cook food directly on the glass cooking tray.

- Place the roller guide around the turntable shaft.
- Place the glass cooking tray on the roller guide.

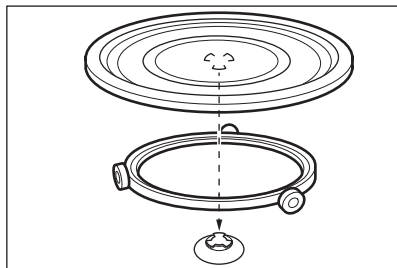

## Inserting the grill rack

### ⚠ CAUTION!



Grill rack can not be used with the microwave function. There is a risk of damage to the appliance. Use the grill rack only with the Grill function.

Place the grill rack on the turntable set.

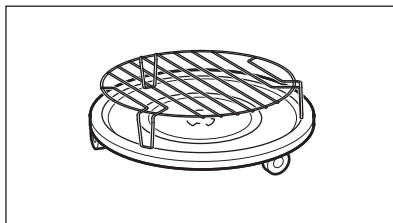

## ADDITIONAL FUNCTIONS

### Child Safety Lock

The Child Safety Lock prevents an accidental operation of the microwave.

Press and hold  for 3 seconds.

An acoustic signal sounds.

When the Child Safety Lock is active the display shows .

To deactivate the Child Safety Lock press and hold  for 3 seconds.

An acoustic signal sounds.

### Kitchen Timer

You can set a maximum 95 minutes.



 When the Kitchen Timer function is active no other programme can be set.



1. Press .
2. Press the Setting pads to set the time.  
After 2 seconds the timer starts automatically.  
The Timer stops working when you open the door or pause the appliance. When you continue to cook the timer returns to the previous set time.

When the set time is reached, an acoustic signal sounds.

### Setting the Clock



 You can set the time in 12 hour or 24 hour clock system.

1. Press  until 12H or 24H format is displayed.
2. Press Setting pads to enter the amount of hours.
3. Press  to confirm.
4. Press Setting pads to enter the amount of minutes.
5. Press  to confirm.

 If you do not want the clock visible on the display, press  until the display shows OFF and press  to confirm. The display shows 00:00 and turns off automatically after 5 min.

### Muting the touch key sound

The function allows to mute the touch key sound.

1. Open the door.
2. Press and hold  and press  simultaneously. OFF is displayed.
3. Close the door.

To turn on the sound, repeat the procedure above. ON is displayed.

## HINTS AND TIPS

### **WARNING!**

Refer to Safety chapters.

### Tips for the microwave cooking

Problem	Remedy
You cannot find details on the amount of food prepared.	Look for a similar type of food. Increase or shorten the length of the cooking times according to the following rule: <ul style="list-style-type: none"><li>• Double the amount almost double the time.</li><li>• Half the amount is a half time.</li></ul>
The food got too dry.	Set a shorter cooking time or select a lower microwave power.
The food is not defrosted, hot or cooked when the time ends.	Set a longer cooking time or a higher power. Note that large dishes need a longer time.
After the cooking time ends, the food is overheated on the outside, but still not ready inside.	Next time set a lower power and a longer time. Stir liquids halfway through, e.g. soup.
Rice cooking results are poor.	To get better results for rice use a flat, wide dish.

### Defrosting

Always defrost roast fat side down.

Do not defrost covered meat as it may cause cooking instead of defrosting.

Always defrost whole poultry breast side down.

### Cooking

Always remove chilled meat and poultry from the refrigerator at least 30 minutes before cooking.

Let the meat, poultry, fish and vegetables stay covered after cooking.

Brush a little oil or melted butter over the fish.

All vegetables should be cooked at the full microwave power.

Add 30 - 45 ml of cold water for every 250 g of vegetables.

Cut fresh vegetables into even sized pieces before cooking. Cook all vegetables with a cover on the container.

### Reheating

When you reheat packed ready meals always follow the instruction written on the packaging.

### Grilling

Grill flat food items in the middle of the grill rack.

Turn the food over halfway through the set time and continue grilling.

### Combi Cooking

Use Combi Cooking to keep the crispness of certain foods.

Halfway through the cooking time turn the foods over and then continue cooking.

There are 2 modes for Combi Cooking. Each mode combines the microwave and the grill functions at different time periods and power levels.

## CARE AND CLEANING

### **WARNING!**

Refer to Safety chapters.

### Notes and tips on cleaning

- Clean the front of the appliance with a soft cloth with warm water and a cleaning agent.
- To clean metal surfaces, use a usual cleaning agent.
- Clean the interior of the appliance after each use to keep it in good condition. Remove food remains regularly. Make sure to get rid of excess steam/humidity.
- Clean stubborn dirt with a special cleaner.
- Clean all accessories regularly and let them dry. Use a soft cloth with warm water and a cleaning agent.

- To soften the remains that are hard to remove boil a glass of water at the full microwave power for 2 to 3 minutes.
- To remove odours, mix a glass of water with 2 tsp of lemon juice and boil at full microwave power for 5 minutes.

### How to use: Aqua Clean

This cleaning procedure uses humidity to remove remaining fat and food particles from the appliance.



1. Place a glass containing 200 ml of water in the center of the glass cooking tray.
2. Set the power to 900 W.
3. Let the appliance work for 3 min.
4. Wait until the appliance is cold. Dry the cavity with a soft cloth.

## TROUBLESHOOTING

### **WARNING!**

Refer to Safety chapters.

### What to do if...

Problem	Possible cause	Remedy
The appliance does not operate.	The appliance is not plugged in.	Plug in the appliance.
The appliance does not operate.	Lack of Electrical Power Supply.	Check the fuse or the main switch. If the fuse or the switch continue to break the circuit, contact a qualified electrician.
The appliance does not operate.	The door is not closed properly.	Make sure that nothing blocks the door.
The lamp does not operate.	The lamp is defective.	The lamp has to be replaced.
The display shows  .	The Child Safety Lock is active.	Deactivate the Child Safety Lock. Hold  for 3 seconds.
There is sparking in the cavity.	There is a metal dish or a dish with a metal trim inside.	Remove the dish from the appliance.
There is sparking in the cavity.	There is a metal skewer or some aluminium foil inside that touches the interior walls.	Make sure that the skewer or foil does not touch the interior walls.

Problem	Possible cause	Remedy
The turntable set makes a scratching or grinding noise.	There is an object or dirt below the glass cooking tray.	Clean the area below the glass cooking tray.
The appliance stops operating without a clear reason.	There is a malfunction.	If this situation repeats itself, call the Authorised Service Centre.

### Service data

If you cannot find a solution to the problem yourself, contact your dealer or an Authorised Service Centre.

The necessary data for the service centre is on the rating plate. The rating plate is on the appliance. Do not remove the rating plate from the appliance.

### We recommend that you write the data here:

Model (MOD.)	..... ...
Product number (PNC)	..... ...
Serial number (S.N.)	..... ...

## ENERGY EFFICIENCY

### Product Information for power consumption and maximum time to reach applicable low power mode

Power consumption in standby with display on	0.8 W
--	----------

Power consumption in standby with display off	0.5 W
---	----------

Maximum time needed for the equipment to automatically reach the applicable low power mode	20 min
--	-----------

## ENVIRONMENTAL CONCERNS

Recycle materials with the symbol . Put the packaging in relevant containers to recycle it. Help protect the environment and human health by recycling waste of electrical and electronic appliances. Do not dispose of ap-

pliances marked with the symbol  with the household waste. Return the product to your local recycling facility or contact your municipal office.



UK  
CA