

SIEMENS

ER3A.BI4.

Built-in gas hob



EN Information for Use



Register your appliance on My Siemens
and discover exclusive services and offers.



Siemens Home Appliances

ER3A.BI4.

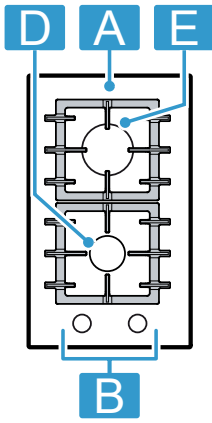

| ¹ | Component | |
|--------------|------------------------|----------------|
| A | Pan support | - |
| B | Control knob | - |
| D | Standard-output burner | 1.60 / 1.75 kW |
| E | High-output burner | 2.80 / 3.00 kW |

¹ The images shown in these instructions are for guidance only.

You can find additional information and explanations online.
Scan the QR code on the title page.



Table of contents

| | | | | | |
|---|--|---|----|--|----|
| 1 | Safety | 3 | 7 | Cookware | 8 |
| 2 | Preventing material damage | 5 | 8 | Recommended settings for cooking | 9 |
| 3 | Environmental protection and saving energy | 6 | 9 | Cleaning and servicing | 10 |
| 4 | Familiarising yourself with your appliance | 6 | 10 | Troubleshooting | 11 |
| 5 | Accessories | 7 | 11 | Customer Service | 12 |
| 6 | Basic operation | 8 | 12 | Disposal | 12 |

1 Safety

Observe the following safety instructions.

1.1 General information

- Read this instruction manual carefully.
- Keep the instruction manual and the product information safe for future reference or for the next owner.
- Do not connect the appliance if it has been damaged in transit.

1.2 Intended use

The appliance can only be used safely if it is correctly installed according to the safety instructions. The installer is responsible for ensuring that the appliance works perfectly at its installation location.

CAUTION – Risk of injury!

This appliance is for cooking purposes only.

- ▶ It shall not be used for other purposes, for example room heating.

Only use this appliance:

- To prepare meals and drinks.
- Under supervision. Never leave the appliance unattended when cooking for short periods.
- In a private household and in a domestic environment.
- Up to an altitude of 2000 m above sea level.

Do not use the appliance:

- On boats or in vehicles.
- as a room heater.
- with an external timer or a remote control.
- Outdoors.

Call the after-sales service if you want to convert your appliance to a different type of gas.

1.3 Restriction on user group

This appliance may be used by children aged 8 or over and by people who have reduced physical, sensory or mental abilities or inadequate experience and/or knowledge, provided that they are supervised or have been instructed on how to use the appliance safely and have understood the resulting dangers.

Do not let children play with the appliance.

Children must not perform cleaning or user maintenance unless they are at least 15 years old and are being supervised.

Keep children under the age of 8 years away from the appliance and power cable.

1.4 Safe use

WARNING – Risk of explosion!

Escaping gas may cause an explosion.

WHAT TO DO IF YOU SMELL GAS OR IF THERE ARE FAULTS IN THE GAS INSTALLATION

- ▶ Immediately shut off the gas supply or close the gas cylinder valve.
- ▶ Immediately extinguish all naked flames and cigarettes.
- ▶ Do not operate any light switches or appliance switches.
- ▶ Do not pull any plugs out of any sockets.
- ▶ Do not use any telephones or mobile phones within the building.
- ▶ Open windows and ventilate the room.
- ▶ Call the after sales service or the gas supplier.

Escaping gas may cause an explosion. Small amounts of gas can collect over a longer period of time and ignite.

- ▶ Close the safety valve for the gas supply when the appliance is out of use for prolonged periods.

Escaping gas may cause an explosion.

If the liquefied gas bottle is not upright, liquefied propane/butane can enter the appliance. Intense darting flames may therefore escape from the burners. Components may become damaged and start to leak over time so that gas escapes uncontrollably.

- ▶ Always use liquefied gas bottles in an upright position.

⚠ WARNING – Risk of poisoning!

The use of a gas cooking appliance results in the production of heat, moisture and products of combustion in the room in which it is installed. Ensure that the kitchen is well ventilated especially when the appliance is in use.

- ▶ Prolonged intensive use of the appliance may require additional ventilation, for example the increasing of mechanical ventilation where present, additional ventilation to safely remove the products of combustion to outside (external) air whilst also providing room air changes with additional ventilation.
- ▶ Consult a professional before installation of the additional ventilation.

⚠ WARNING – Risk of fire!

Leaving fat or oil cooking on an unattended hob can be dangerous and may lead to fires.

- ▶ Never leave hot oil or fat unattended.
- ▶ Never attempt to extinguish a fire using water; instead, switch off the appliance and then cover with a lid or a fire blanket.

The appliance becomes very hot.

- ▶ Never place flammable objects on the cooktop or in its immediate vicinity.
- ▶ Never store any objects on the cooktop.

The appliance will become hot.

- ▶ Do not keep combustible objects or aerosol cans in drawers directly underneath the hob.
- ▶ Never store or use combustible materials (e.g. spray cans or cleaning agents) under the appliance or in its immediate vicinity.

Hob covers can cause accidents, for example due to overheating, catching fire or materials shattering.

- ▶ Do not use hob covers.

When gas burners are in operation without any cookware placed on them, they can build up a

lot of heat. The extractor hood above it may become damaged or catch fire.

- ▶ Only operate the gas burners with cookware on them.

The appliance becomes very hot, fabrics and other objects may ignite.

- ▶ Keep fabrics (e.g. garments or curtains) away from the flames.
- ▶ Never reach over the flames.
- ▶ Do not place combustible objects (e.g. tea towels or newspapers) on, next to or behind the appliance.

Escaping gas may ignite.

- ▶ If the burner does not ignite after 10 seconds, turn the control knob to the "Off" position and open the door or window in the room. do not attempt to re-ignite the burner for at least one minute.
- ▶ In the event of the burner flames being accidentally extinguished, turn off the burner control and do not attempt to re-ignite the burner for at least one minute.

Food may catch fire.

- ▶ The cooking process must be monitored. A short process must be monitored continuously.

⚠ WARNING – Risk of burns!

The accessible parts can become hot during operation.

- ▶ Small children should be kept away from the appliance.

Hob guards may cause accidents.

- ▶ Never use hob guards.

Empty cookware becomes extremely hot when set on gas burners that are operating.

- ▶ Never heat up empty cookware.

The appliance becomes hot during operation.

- ▶ Allow the appliance to cool down before cleaning.

⚠ WARNING – Risk of electric shock!

Improper repairs are dangerous.

- ▶ Repairs to the appliance should only be carried out by trained specialist staff.
- ▶ Only use genuine spare parts when repairing the appliance.
- ▶ If the power cord of this appliance is damaged, it must be replaced by the manufacturer, the manufacturer's Customer Service or a similarly qualified person in order to prevent any risk.

If the appliance or the power cord is damaged, this is dangerous.

- ▶ Never operate a damaged appliance.

- ▶ Never pull on the power cord to unplug the appliance. Always unplug the appliance at the mains.
- ▶ If the appliance or the power cord is damaged, immediately unplug the power cord or switch off the fuse in the fuse box and turn off the gas supply.

▶ Call customer service. → *Page 12*

An ingress of moisture can cause an electric shock.

- ▶ Do not use steam- or high-pressure cleaners to clean the appliance.

The insulation on cables of electrical appliances may melt if it touches hot parts of the appliance.

- ▶ Never bring electrical appliance cables into contact with hot parts of the appliance.

⚠ **WARNING – Risk of injury!**

Faults or damage to the appliance and repairs that have not been carried out correctly are dangerous.

- ▶ Never switch on the appliance if there is a fault with it.
- ▶ If the appliance is faulty, unplug the mains plug or switch off the fuse in the fuse box. Shut off the gas supply and call the after sales service.
- ▶ Always have repairs carried out to the appliance and damaged gas lines replaced by trained, specialist personnel.

Cracks or fractures in the glass surface are dangerous.

- ▶ All of the burners and each electrical heating element switch off immediately and disconnect the appliance from the power supply.
- ▶ Shut off the gas supply.
- ▶ Do not touch the surface of the appliance
- ▶ Do not use the appliance.
- ▶ Call the customer service.

Cookware that is not the right size, or that is damaged or incorrectly positioned may cause serious injuries.

- ▶ See the notes on cookware.

When switching on the burner, sparks are generated in the ignition plugs.

- ▶ Never touch the ignition plugs while the burner is being lit.

If a control knob is too stiff to turn or it is loose, it must no longer be used.

- ▶ Contact our after-sales service immediately to have the control knob repaired or replaced.

An appliance with a cracked or broken surface can cause cuts.

- ▶ Do not use the appliance if it has a cracked or broken surface.

⚠ **WARNING – Danger: Magnetism!**



Caution: Magnetic field



Attention for persons with pacemakers
Permanent magnets are integrated in the control element bases and the control elements. Magnets may affect electronic implants, e.g. heart pacemakers or insulin pumps.

- ▶ Persons with electronic implants must stand at least 10 cm away from the magnetic control element bases and control elements.
- ▶ Never carry the control element base and the control elements on your body.

⚠ **WARNING – Risk of suffocation!**

Children may put packaging material over their heads or wrap themselves up in it and suffocate.

- ▶ Keep packaging material away from children.
- ▶ Do not let children play with packaging material.

Children may breathe in or swallow small parts, causing them to suffocate.

- ▶ Keep small parts away from children.
- ▶ Do not let children play with small parts.

2 Preventing material damage

ATTENTION

Heat can cause damage to adjacent appliances or kitchen units.

If the appliance is in operation for an extended period, heat and moisture will be generated.

- ▶ Open a window or switch on an extractor hood leading to the outside.

A build-up of heat may damage the appliance.

- ▶ Do not use two burners or heat sources to heat one single item of cookware.
- ▶ Do not use griddle plates, clay pots, etc. for a long time at full power.

A build-up of heat may damage the controls.

- ▶ Do not use a large item of cookware on burners that are close to the control knobs.

If a control knob is in the wrong position, this could lead to malfunctions.

- ▶ Always turn the control knob to the "Off" position when the appliance is not being used.

Handling the cookware roughly may damage the surface of the appliance.

- ▶ Handle the cookware on the hob carefully.
- ▶ Do not place any heavy objects on the hob.

Moving the cookware may scratch the glass.

- ▶ Lift the cookware when moving it.

Damage may occur if hard or pointed objects fall on the hob.

- ▶ Do not let hard or pointed objects fall onto the hob.
- ▶ Do not bump into any of the edges of the hob.

Salt, sugar or sand that may fall from the vegetables will scratch the glass.

- ▶ Do not use the hob as a work surface or storage space.

Melted sugar or food with a high sugar content may damage the glass.

- ▶ Remove boiled-over food immediately with a glass scraper.

3 Environmental protection and saving energy

3.1 Saving energy

If you follow these instructions, your appliance will use less energy.

Choose a burner roughly the same size as your pan. Centre the cookware on the hob.

Tip: Cookware manufacturers often give the upper diameter of the saucepan. It is often larger than the base diameter.

- ✓ Unsuitable cookware or incompletely covered cooking zones consume a lot of energy.

Cover saucepans with suitable lids.

- ✓ Cooking without a lid consumes considerably more energy.

Lift lids as infrequently as possible.

- ✓ When you lift the lid, a lot of energy escapes.

Using a glass lid

- ✓ You can see into the pan through a glass lid without having to lift it.

Use cookware that is suitable for the quantity of food.

- ✓ Large items of cookware containing little food need more energy to heat up.

Cook with only a little water.

- ✓ The more water there is in the cookware, the more energy that is required to heat it up.

Turn down to a lower power level early on.

- ✓ If you use an ongoing power level that is too high, you will waste energy.

3.2 Disposing of packaging

The packaging materials are environmentally compatible and can be recycled.

- ▶ Sort the individual components by type and dispose of them separately.

4 Familiarising yourself with your appliance



4.1 Control knob

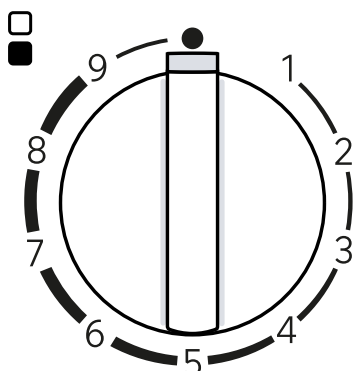

You can use the control knobs to set the flame height to different power levels.





| | |
|---|--|
| 9 | Highest power setting and electric ignition of the burner. |
| 1 | Lowest power setting. |

Removable control knob

You can remove the appliance's control knob. The control knob  is magnetic and connected to the control knob base . Remove the control knob upward.

| | |
|---|--------------------------------------|
|  | Burner assigned to the control knob. |
|  | Burner off. |

Note: Never remove the control knob base  and its holder . Only Customer Service can reinsert the control knob base and its holder.

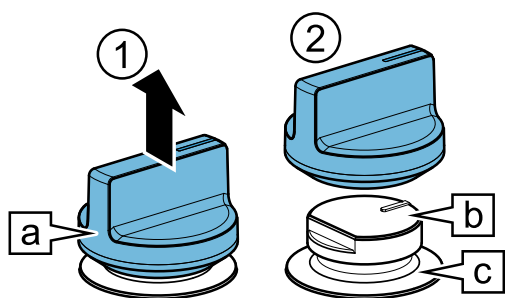

To put the control knob back on, press it on at its original position.

Tip: The magnets can interfere with magnetic data carriers, TV sets and displays. Keep magnetic data carriers, e.g., credit cards or other cards with magnetic strips, TV sets and monitors away from the device's control knob.

4.2 Burner

You can find an overview of the parts of the burner here.

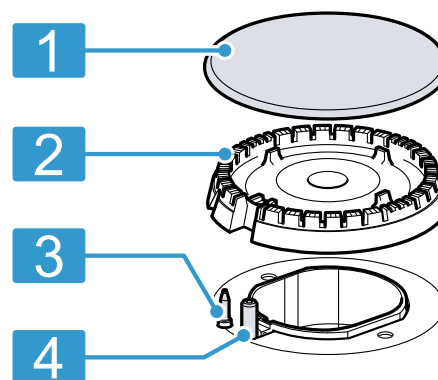

- | | |
|---|---------------------------------------|
| 1 | Burner cover |
| 2 | Burner cup |
| 3 | Thermocouple for the flame monitoring |
| 4 | Ignition plug |

4.3 Pan supports

Insert the pan supports correctly. → *Page 2*
Place the cookware correctly on the pan supports.
Never place the cookware directly on the burner.
Always carefully remove the pan supports.

Tip: You can remove the metal residue that remains when some items of cookware are moved on the pan support by cleaning it properly.
→ *"Cleaning and servicing", Page 10*

5 Accessories

You can buy accessories from the after-sales service, from specialist retailers or online. Only use original accessories, as these have been specifically designed for your appliance.

Accessories vary from one appliance to another. When purchasing accessories, always quote the exact product number (E no.) of your appliance. → *Page 12*

You can find out which accessories are available for your appliance in our catalogue, in the online shop or from our after-sales service.

siemens-home.bsh-group.com

Accessories

Additional wok grid

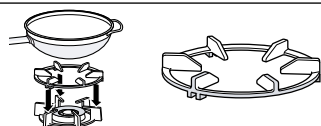

Use

- Only use on the multi-crown burner.
- Always use for cookware with a rounded base.
- Recommended in order to extend the service life of the appliance.

Additional espresso maker grid

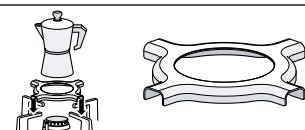

- Only use on the burner with the lowest power setting.
- Use with cookware with a diameter smaller than 12.

| Accessories | Use |
|--------------------------|---|
| Simmer plate | <ul style="list-style-type: none"> ■ Use for cooking on a low heat. ■ Place it on the pan support with the bumps facing up – never place it directly on the burner. ■ Use the economy burner or the half-rapid burner. If you have multiple half-rapid burners, use the rear burner. |
| Installation accessories | To combine appliances of the same brand, use the installation accessory. |

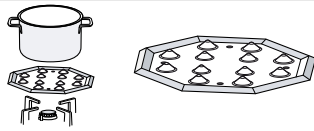

6 Basic operation

6.1 Igniting a gas burner

The hob has automatic ignition of the burners.

⚠ **WARNING – Risk of fire!**

Escaping gas may ignite.

- ▶ If the burner does not ignite after 10 seconds, turn the control knob to the "Off" position and open the door or window in the room. do not attempt to re-ignite the burner for at least one minute.
- ▶ In the event of the burner flames being accidentally extinguished, turn off the burner control and do not attempt to re-ignite the burner for at least one minute.

ATTENTION

If you turn the control knob directly between position ● and 1, malfunctions may occur.

- ▶ For this reason, never turn directly from position ● to position 1 or vice versa.
1. Press the control knob for the selected burner and turn it anti-clockwise to the highest level. Keep the control knob pressed in.
 - ✓ For all of the burners, sparks are generated and the flame ignites in the selected burner.
 2. Wait a few seconds and release the control knob. → "Safety system", Page 8
 3. Turn the control knob to the required position.
 4. If the burner does not ignite, turn the control knob to the off position and repeat the steps described above. This time, hold the control knob down for longer (up to 10 seconds).

Note

Take the following information into account to ensure that the appliance works correctly:

- The burner parts and the pan supports must be inserted correctly.
- Do not swap the burner caps around.
- The burner holes and grooves must be clean to ensure a correct flame.

→ "Cleaning recommendations", Page 10

6.2 Safety system

The safety system (thermocouple) prevents the flow of gas if the flames accidentally go out. To ignite the burner, you must activate the system that enables the gas flow.

1. Ignite the burner without releasing the control knob. ✓ The flame ignites.
2. Press and hold the control knob for a further four seconds.

6.3 Igniting a gas burner manually

In the event of a power cut, you can light the burners manually.

1. Press the control knob for the selected burner and turn it anti-clockwise to the highest level.
2. Hold a lighter or a flame (lighter, match, etc.) against the burner.

6.4 Switching off a burner

- ▶ Turn the control knob clockwise to ●.

6.5 Normal behaviour during operation

This behaviour is normal for the appliance:

- Slight hissing noise from the ignited burner.
- Release of odours when using the appliance for the first time. These odours disappear after a short time.
- An orange flame is normal. This is due to dust in the environment, spilled liquids, etc.
- Popping noise a few seconds after the burner is switched off. This is caused by switching on the safety system. → "Safety system", Page 8

7 Cookware

This information has been provided to help you save energy and avoid damaging your cookware.

7.1 Suitable cookware

Only use cookware with a suitable diameter. The cookware must not protrude over the edge of the hob. Never use small cookware on large burners. The flames must not touch the sides of the cookware.

| Burner | Minimum diameter of the cookware base (cm) | Maximum diameter of the cookware base (cm) |
|------------------------|--|--|
| High output burner | 20 | 26 |
| Standard output burner | 12 | 22 |

Only use cookware with a concave base on the multi-crown burner.

- The hob must have a multi-crown burner and additional wok grid.
- The additional wok grid must be correctly inserted.

→ "Accessories", Page 7

7.2 Using cookware

The selection and positioning of the cookware affects the safety and energy efficiency of your appliance.

→ "Saving energy", Page 6

WARNING – Risk of fire!

Flammable objects may ignite.

- ▶ Maintain a distance of at least 50 mm between the cookware and flammable objects.

| | |
|--|--|
| Do not use deformed cookware. Only use cookware with a thick, flat base. | Deformed cookware is not stable on the hob and may tip over. |
|--|--|

| | |
|---|--|
| Place the cookware right in the centre of the burner. | The cookware may tip over if it is not placed in the centre of the burner. |
|---|--|

| | |
|---|---|
| Place the cookware correctly on the pan supports. | The cookware may tip over if you place it directly on the burner. |
|---|---|

8 Recommended settings for cooking

You can use the control knobs on the appliance to set the flame height incrementally to different power levels from 1 to 9.

The cooking times and power levels may vary depending on the type of food, its weight and quality, on the type of gas used, and on the material from which the cookware is made.

Tips

- Cooking tips
 - When cooking soups, creams, lentils or chickpeas, add all of the ingredients to the cookware at the same time.
 - For pan-fried dishes, heat the oil up first. As soon as you have started frying, keep the temperature constant and adjust the power level as required. When preparing several portions, wait until the relevant temperature has been reached again. Turn the food regularly.
- To reduce the cooking time:
 - Use a pressure cooker to cook creams and pulses. If you are using a pressure cooker, follow the manufacturer's instructions.
 - The water must be boiling before you add pasta, rice or potatoes. Then adjust the power level in order to continue boiling.
 - Always use a lid when cooking rice and potatoes.

| Power level | Preparing meals |
|-------------|--|
| 9 | <ul style="list-style-type: none"> ▪ Bringing water to the boil ▪ Baking in a bain-marie: Sponge, blanc-mange, bread pudding. ▪ Frying at a high temperature: Asian dishes. |

| Power level | Preparing meals |
|-------------|---|
| 7-9 | <ul style="list-style-type: none"> ▪ Starting the cooking process: Pasta, soups, creams, paella, pulses, rice pudding. ▪ Deep-fat frying in oil: Tempura vegetables, croquettes, chips, potato omelettes, escalope, frozen food, baked items. ▪ Frying with a little oil: French omelette, steak, well-done sirloin steak, stroganoff. ▪ Frying, searing: Vegetables, meat. |
| 4-6 | <ul style="list-style-type: none"> ▪ Continuing the cooking process: Pasta, soups, creams, paella, pulses, rice pudding. ▪ Deep frying with a little oil: Hamburgers, sausages, grilled salmon, rissoles. ▪ Stew, pot roast: Ragout, goulash, ratatouille. ▪ Cooking at a medium temperature: Cheese sauce, béchamel, carbonara, Neapolitana sauce, blancmange, crepes. ▪ Defrosting: Frozen food. |
| 1-3 | <ul style="list-style-type: none"> ▪ Finishing cooking: Paella rice, pulses, rice pudding. ▪ Steaming: Fish, vegetables. ▪ Heating and keeping warm: Ready-to-eat meals. |
| 1 | <ul style="list-style-type: none"> ▪ Melting: Butter, chocolate, butter, gelatine, honey, caramel. |

9 Cleaning and servicing

To keep your appliance working efficiently for a long time, it is important to clean and maintain it carefully.

9.1 Cleaning product

You can obtain suitable cleaning products from after-sales service or the online shop siemens-home.bsh-group.com.

ATTENTION

Unsuitable cleaning products may damage the surfaces of the appliance.

- ▶ Do not use harsh or abrasive detergents.

9.2 Cleaning recommendations

Clean all parts of the appliance after each use.

Note: Read the information on the cleaning agents.

→ "Cleaning product", Page 10

General information:

- Allow the appliance to cool down before cleaning.
- After cleaning, dry all parts of the appliance completely using a soft cloth. Surface damage may occur if there are still drops of water or residual moisture at the beginning of the cooking process.
- Reattach the parts of the appliance properly, making sure that the surfaces are not damaged.
→ "Familiarising yourself with your appliance", Page 6

| Part | Recommended cleaning method | Notes |
|-------------------|---|--|
| Appliance surface | Clean using a sponge and soapy water. | <ul style="list-style-type: none"> ▪ Wipe up spilled liquids immediately. This prevents food residues from burning. ▪ The control elements can be removed for easier cleaning. Never remove the control element base or its holder. → "Removable control knob", Page 6 After cleaning, check the correct position of the control element bases and holders. |
| Control elements | Clean using a damp sponge cloth and hot soapy water. | <ul style="list-style-type: none"> ▪ The control elements can be removed for easier cleaning. Never remove the plinth for the control elements or its holder. → "Removable control knob", Page 6 ▪ Do not clean it in the dishwasher or immerse it in water, as this may damage it. ▪ Do not use abrasive or corrosive products, such as citric acid, vinegar, aggressive cleaning agents or glass ceramic cleaners. |
| Pan supports | Cleaning by hand: <ul style="list-style-type: none"> ▪ Scrub with a non-metallic brush or a non-scratching scouring sponge and soapy water. Cleaning in the dishwasher: <ul style="list-style-type: none"> ▪ Clean at a maximum temperature of 60 °C. | <ul style="list-style-type: none"> ▪ Carefully remove the pan supports. ▪ Carefully clean the area around the rubber pads. If the rubber pads come loose, the pan support may scratch the hob. Cleaning in the dishwasher: <ul style="list-style-type: none"> ▪ Use cleaning agents recommended by the dishwasher manufacturer. ▪ Preclean the pan supports if they are particularly dirty. ▪ As soon as the washing process is finished, remove the pan supports from the dishwasher and remove any residual moisture. <p>Tip: The pan supports may discolour during use and cleaning. This discolouration does not affect their use.</p> |
| Burner | Scrub with a non-metallic brush or a non-scratching scouring sponge and soapy water. | <ul style="list-style-type: none"> ▪ Do not clean in the dishwasher. ▪ Do not mix up the burner lids. ▪ Gently move the burner lid back and forth until it locks into the projections on the burner. |

| Part | Recommended cleaning method | Notes |
|------------------------------|---|--|
| Thermocouples/ignition plugs | Clean using a small non-metallic brush. | <ul style="list-style-type: none"> ▪ Clean carefully. Thermocouples and ignition plugs are sensitive. ▪ Do not moisten the thermocouple and the ignition plug. If there is excessive moisture, the burner may not light. |

10 Troubleshooting

You can rectify minor faults on your appliance yourself. Read the troubleshooting information before contacting after-sales service. This will avoid unnecessary costs.

WARNING – Risk of injury!

Improper repairs are dangerous.

- ▶ Repairs to the appliance should only be carried out by trained specialist staff.
- ▶ If the appliance is defective, call Customer Service.
→ "Customer Service", Page 12

WARNING – Risk of electric shock!

Improper repairs are dangerous.

- ▶ Repairs to the appliance should only be carried out by trained specialist staff.
- ▶ Only use genuine spare parts when repairing the appliance.
- ▶ If the power cord of this appliance is damaged, it must be replaced by the manufacturer, the manufacturer's Customer Service or a similarly qualified person in order to prevent any risk.

10.1 Malfunctions

| Fault | Cause and troubleshooting |
|---|--|
| The general electrical operation is impaired. | The circuit breaker is faulty. ▶ Check the circuit breaker in the fuse box. |
| | The circuit breaker or one of the residual-current circuit breakers has been triggered. ▶ In the fuse box, check whether the circuit breaker or one of the residual-current circuit breakers has been triggered. |
| | The mains plug of the power cord is not plugged in. ▶ Connect the appliance to the power supply. |
| | There has been a power cut. ▶ Check whether the lighting in your room or other appliances are working. |
| Automatic ignition is not working. | Food remnants or dirt are located between the ignition plug and the burner. ▶ Clean the space between the ignition plugs and burners. |
| | Burner parts are wet. ▶ Carefully dry the burner parts. |
| | The burner parts are positioned incorrectly. ▶ Correctly position the burner parts. |
| | The appliance is not earthed or has not been connected correctly, or the earth cable is damaged. ▶ Contact an electrician. |
| The burner flame is not uniform. | The burner parts are positioned incorrectly. ▶ Correctly position the burner parts. |
| | Openings on the burner are soiled. ▶ Clean and dry the openings on the burner. |
| Burner flames are large or unstable. | <p>The gas reaches the appliance at excessive pressure.</p> <ol style="list-style-type: none"> 1. Switch off the appliance. 2. Contact an approved installer and have them check the regulator of the gas cylinder or liquid gas tank. <p>Tip: To prevent damage due to excessive pressure, you can install an overpressure safety device that limits or cuts off the gas supply if the regulator of the gas cylinder or liquid gas tank fails.</p> |

| Fault | Cause and troubleshooting |
|--|---|
| The gas does not appear to be flowing normally or there is no gas being produced at all. | The gas supply has been shut off by the intermediate valves. ▶ Open the intermediate valves. |
| There is a smell of gas in the kitchen. | The control knob is open. ▶ Close the control knob. The gas pipe to the appliance is leaking. 1. Close the main gas tap. 2. Ventilate the room. 3. Immediately call an authorised installer, who can inspect the gas system and issue an installation certificate. 4. Do not use the appliance until you are sure that gas is not leaking from the installation or the appliance. |
| The burner switches off as soon as you release the control knob. | Control knob not pressed down long enough. 1. Keep the control knob pressed down for a few seconds after ignition. 2. Press the control knob down firmly. Openings on the burner are soiled. ▶ Clean and dry the openings on the burner. |

11 Customer Service

Function-relevant genuine spare parts according to the corresponding Ecodesign Directive can be obtained from Customer Service for a period of at least 10 years from the date on which your appliance was placed on the market within the European Economic Area. Furthermore, our Customer Service will continue to provide you with other function-relevant and storable genuine spare parts for up to 15 years from the date on which your appliance was placed on the market. For more information, please contact our Customer Service team.

Note: Under the terms of the manufacturer's warranty the use of Customer Service is free of charge.

Detailed information about the warranty period and the warranty conditions in your country is available via the QR code on the enclosed document on service contacts and warranty conditions, from our customer service or on our website.

You can find the contact details for our customer service via the QR code on the enclosed document on service contacts and warranty conditions or on our website. You can find the information required as per Regulations (EU) 66/2014 and (EU) 2023/826 online at siemens-home.bsh-group.com on the product and service pages for your appliance, in the area of user manuals and additional documents.

11.1 Product number (E-Nr.) and production number (FD)

If you contact Customer Service, you will require the product number (E-Nr.) and the production number (FD), which you can find on the appliance's rating plate.

The rating plate can be found:

- on the appliance certificate.
- on the lower section of the hob.

Make a note of your appliance's details and the Customer Service telephone number to find them again quickly.

12 Disposal

12.1 Disposing of old appliance

Valuable raw materials can be reused by recycling.

- 1.** Unplug the appliance from the mains.
- 2.** Cut through the power cord.
- 3.** Close the main gas tap.
- 4.** Dispose of the appliance in an environmentally friendly manner.
Information about current disposal methods are available from your specialist dealer or local authority.



This appliance is labelled in accordance with European Directive 2012/19/EU concerning used electrical and electronic appliances (waste electrical and electronic equipment - WEEE). The guideline determines the framework for the return and recycling of used appliances as applicable throughout the EU.

EN Manufactured by BSH Hausgeräte GmbH under the trademark licence of Siemens AG

Valid within Great Britain:
Imported to Great Britain by
BSH Home Appliances Ltd.
Grand Union House
Old Wolverton Road
Wolverton, Milton Keynes
MK12 5PT
United Kingdom

BSH Hausgeräte GmbH
Carl-Wery-Straße 34
81739 München, GERMANY
siemens-home.bsh-group.com



8001339589 (051204) REG25
en