

Product information

- Indoor use only
- Dimmable - When used with dimmable bulbs
- Replacement bulbs should be the same type and rating, available from John Lewis Partners or other established brands
- Clean the fitting with a soft dry cloth. Do not use abrasive chemical cleaners as this will damage the finish
- Glass parts - Use a dry or slightly damp cloth. Do not use abrasive materials as these will damage the finish. Take care when handling glass parts to avoid damage or injury

Aftercare and Troubleshooting

You've switched on the light, but it's not working:

1. Check your power supply is switched on
2. Turn off the light and check that the bulb is inserted correctly
3. Check the bulb is still in working order

If there are technical issues with this product that you can't solve, please contact your nearest John Lewis & Partners shop or call Technical Support on 03301 230106.

Specification

Max power: 1 x 10W
Recommended bulb:
10W LED E27 GLS bulb for maximum brightness.
Lower wattages are also suitable.
Rated input: 220 -240V, 50Hz
Bulbs not included
IP rating: 20
Weight: 3.70kg

5-year guarantee

At John Lewis & Partners we test every light to high quality standards. That means we can offer you a 5-year guarantee.

Recycling

This symbol  indicates that this product should not be treated as normal household waste and it should be recycled. John Lewis & Partners do not operate instore take back, but as members of the Distributor Take Back scheme have funded the development and upgrade of recycling facilities across the UK. Please take it to your nearest collection facility or for further details contact your local council or visit www.recycle-more.co.uk.

John Lewis plc
SW1V 2QQ
johnlewis.com

Made in China



25/03/2026

Please retain these instructions for future reference.



KIRO PENDANT USER GUIDE

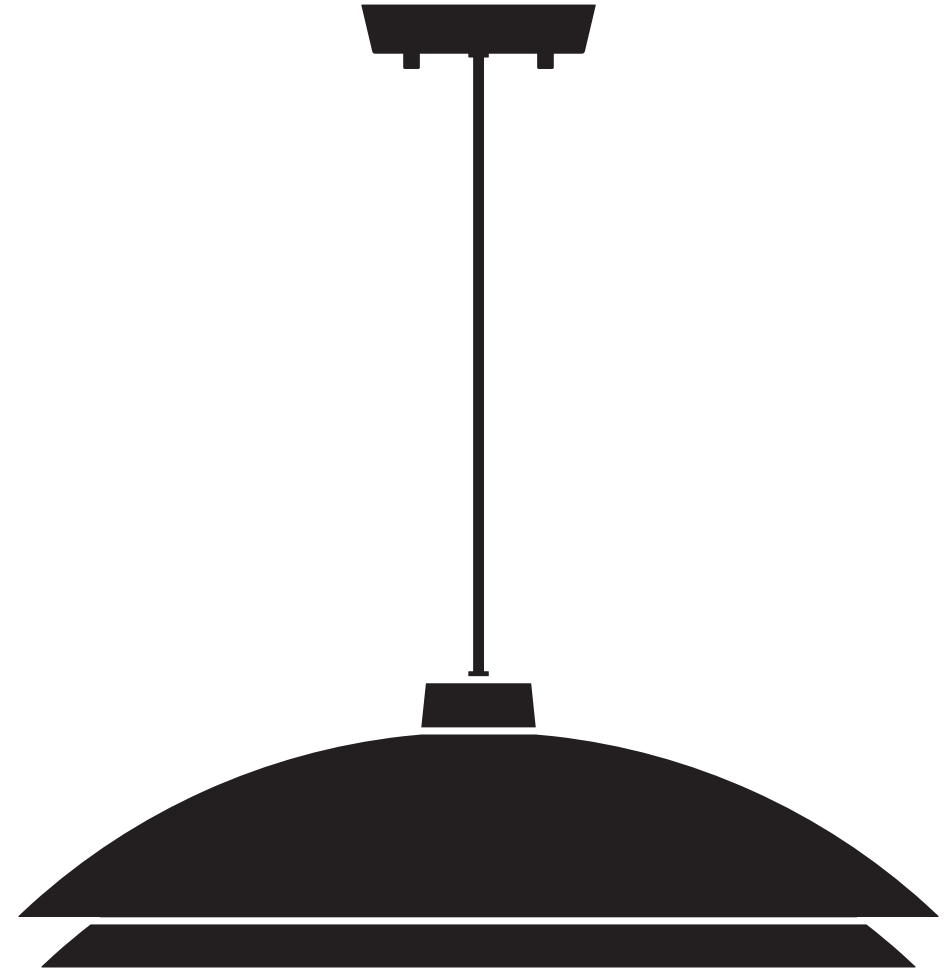

Product Code:
70145302





Getting started

Thank you for purchasing this John Lewis & Partners product. For your safety, and to make sure everything is working properly, please read the instructions carefully before use.

Warnings

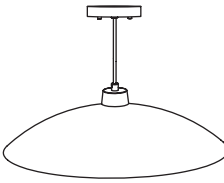
This is a Class 1 product and must be earthed. It is recommended that this fitting is installed by a qualified electrician. Install in accordance with the IEE Wiring regulations and the Building Regulations. To prevent electrocution switch off at mains supply before installing or maintaining this fitting. Ensure other persons cannot restore the electrical supply without your knowledge. If you are in any doubt, please consult a qualified electrician. This light fitting should be connected to a 5 Amp fused circuit. If replacing an existing fitting, make a note of the connections. Always use the correct type and wattage bulb. Never exceed the wattage stated. Dispose of used bulbs carefully. This product is suitable for installation on surfaces with normal flammability e.g. wood, plasterboard, masonry. It is not suitable for use on highly flammable surfaces (e.g. polystyrene, textiles). This product contains glass so care must be taken when fitting or handling to prevent personal injury or damage to the product. For your safety, always switch off the supply and allow the fitting to cool down before changing the lightbulb, cleaning or adjusting.

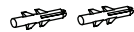
Parts list

Description	Image	Quantity
Light fitting + shade ring (fitted)		x 1
Shade		x 1
Rubber washers (fitted)		x 2
Wall plugs		x 2
Screws		x 2

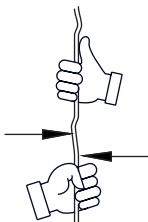

Note:

During transit, the cable can become kinked. It may be necessary to straighten the cable to allow the shade to hang level. Manipulate the kinked cable between thumb and fingers to straighten.

Product assembly

Step 1

Carefully unpack the carton, making sure all the parts are present before assembly. Before removing the existing fitting, carefully note the position of each set of wires. **Please note:** installation maybe easier with the help of an assistant.

Step 2

Remove the fixing bracket (A) from the product by unscrewing the two finials (B) and retain for reuse. Ensure there is a solid mounting surface to support the weight of the light fitting. Using the fixing bracket as a template, mark the position of the mounting holes. Drill holes and fit supplied wall plugs (C) (suitable for masonry only). Take care to avoid damaging any concealed wiring and pipes. Fix the bracket to the ceiling using supplied screws (D).

Step 3

The hanging height of this product can be adjusted. Feed the cable through the cord grip (E) until the desired height is achieved. **Please note:** Do not loosen the cable clamp screw inside the ceiling cup as this is securing the cable into the terminal block.

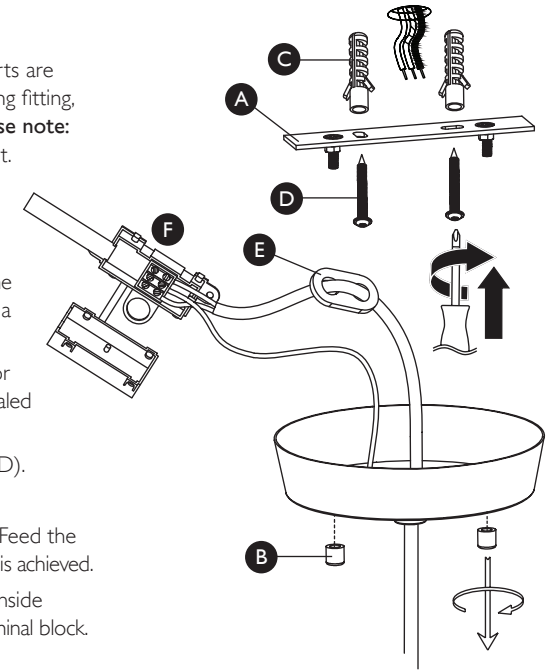

Step 4

Having identified the household wiring from your existing light fitting, connect to the connection block (F) inside the product in the following way. Check that: You have correctly identified the house wires. The connections are tight. No loose strands have been left out of the connection block.

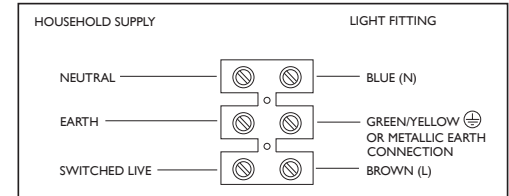

Step 5

Reattach the product to the fixing bracket using the two finials removed in step 2 and tighten to secure. Take care not to trap any wiring.

Step 6

To fit the glass shade (H), first remove the shade ring (J) and one rubber washer (I) from the threaded lampholder. Making sure the other rubber washer (G) is still in place, fit the glass shade, followed by the second rubber washer and refit the shade ring. Tighten with light pressure to secure in place.

Step 7

Fit the recommended bulb (K) as per the details overleaf.

Step 8

Your light is now ready for use.

