

## Product information

- Indoor use only
- Dimmable (dimmer not included)
- Clean the fitting with a soft dry cloth. Do not use abrasive chemical cleaners as this will damage the finish
- Glass parts - Use a dry cloth. Do not use abrasive materials as these will damage the finish. Take care when handling glass parts to avoid damage or injury

## Aftercare and Troubleshooting

If there are technical issues with this product that you can't solve, please contact your nearest John Lewis & Partners shop or call Technical Support on 03301 230106.

## Specification

Max power: 42W  
Rated input: 220 –240V, 50Hz  
IP rating: 20  
Weight: 6.1kg  
Lumen output: 3300  
Colour temperature: Warm white (3000K)  
This product contains a light source of energy efficiency class E  
For further information please visit: [www.lighting-info.co.uk/120702](http://www.lighting-info.co.uk/120702)

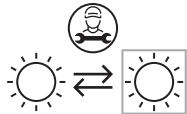

Replaceable light source by a professional

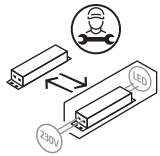

Replaceable control gear by a professional

## 5-year guarantee

At John Lewis & Partners we test every light to high quality standards. That means we can offer you a 5-year guarantee.

## Recycling

This symbol  indicates that this product should not be treated as normal household waste and it should be recycled. John Lewis & Partners do not operate instore take back, but as members of the Distributor Take Back scheme have funded the development and upgrade of recycling facilities across the UK. Please take it to your nearest collection facility or for further details contact your local council or visit [www.recycle-more.co.uk](http://www.recycle-more.co.uk).

John Lewis plc  
SW1V 2QQ  
[johnlewis.com](http://johnlewis.com)

Made in China



05/09/2025

Please retain these instructions for future reference.

JOHN  
LEWIS  
& PARTNERS

# CLARICE PENDANT USER GUIDE



Product Code:  
70140711



## Getting started

Thank you for purchasing this John Lewis & Partners product. For your safety, and to make sure everything is working properly, please read the instructions carefully before use.

## Warnings

This is a Class II product and must NOT be earthed. It is recommended that this fitting is installed by a qualified electrician. Install in accordance with the IEE Wiring regulations and the Building Regulations. To prevent electrocution switch off at mains supply before installing or maintaining this fitting. Ensure other persons cannot restore the electrical supply without your knowledge. If you are in any doubt, please consult a qualified electrician. This light fitting should be connected to a 5 amp fused circuit. If replacing an existing fitting, make a note of the connections. This product is suitable for installation on surfaces with normal flammability e.g. wood, plasterboard, masonry. It is not suitable for use on highly flammable surfaces (e.g. polystyrene, textiles). When moving or cleaning, always switch off at the mains and allow the module to cool before handling. This product contains glass so care must be taken when fitting or handling to prevent personal injury or damage to the product.

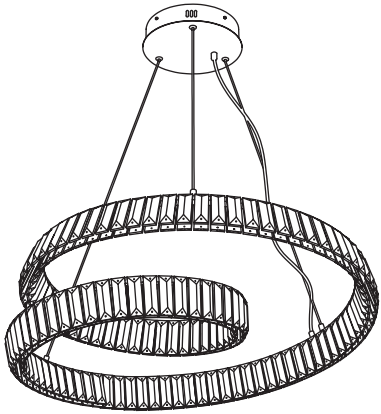
## Parts list

Description	Image	Quantity
Light fitting		x 1
Wall plugs		x 4
Screws		x 4

## Product assembly

### Step 1

Carefully unpack the carton, making sure all the parts are present before assembly. Before removing the existing fitting, carefully note the position of each set of wires.

### Step 2

Remove the fixing bracket (A) from the product by unscrewing the four side screws (B) and retain for reuse.

Ensure there is a solid mounting surface to support the weight of the light fitting. Using the fixing bracket as a template, mark the position of the mounting holes. Drill holes and fit supplied wall plugs (C) (suitable for masonry only). Take care to avoid damaging any concealed wiring and pipes. Fix the bracket to the ceiling using supplied screws (D).

**Please note: This is a heavy product and appropriate ceiling fittings MUST be used to support the weight.**

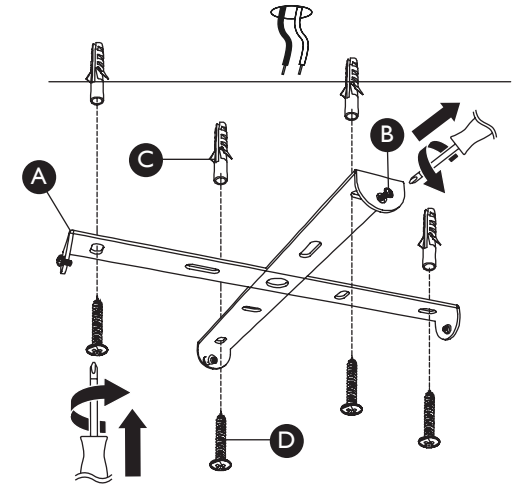

### Step 3

This will be easier to complete before attaching the product to the ceiling. The length of drop of this product can be altered by pulling the cable through the cord grip (E) and by adjusting the length of the steel cables. To reduce the length of the steel cables, push them into the ceiling cover. To increase their length, push in the button (F) to release each cable. Always ensure that the weight of the product is supported by the steel cables and not the electrical flex. Take care not to tangle the cables when unpacking and installing.

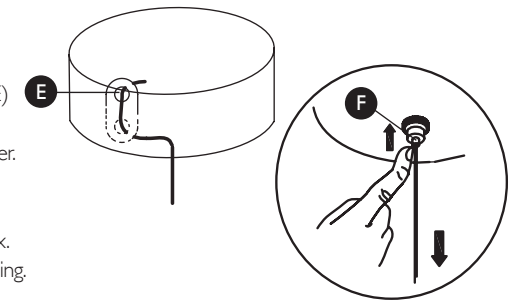

### Step 4

Having identified the household wiring from your existing light fitting, connect the house wiring to the connection block - see wiring diagram (G). Connect Live cable to terminal marked 'L' and Neutral cable to terminal marked 'N'.

**NOTE: This is a Class II fitting and must NOT be connected to earth.**

#### Check that...

You have correctly identified the house wires.  
The connections are tight.  
No loose strands have been left out of the connection block.  
Make sure the lid of the connection box is securely fixed.

### Step 5

Re attach the product to the fixing bracket using the screws removed in step 2 and tighten to secure. Take care not to trap any wiring.

Your light is now ready for use.

