

## Product information

- Indoor use only
- Dimmable - When used with dimmable bulbs
- Replacement bulbs should be the same type and rating, available from John Lewis Partners or other established brands
- Clean the fitting with a soft dry cloth. Do not use abrasive chemical cleaners as this will damage the finish

## Aftercare and Troubleshooting

### You've switched on the light, but it's not working:

1. Check your power supply is switched on
2. Turn off the light and check that the bulb is inserted correctly
3. Check the bulb is still in working order

If there are technical issues with this product that you can't solve, please contact your nearest John Lewis & Partners shop or call Technical Support on 03301 230106.

## Specification

Max power: 1 x 6W  
Recommended bulb:  
6W LED E14 Candle bulb for maximum brightness.  
Lower wattages are also suitable.  
Rated input: 220 –240V, 50Hz  
Bulbs not included  
IP rating: 20  
Weight: 0.5kg

## 5-year guarantee

At John Lewis & Partners we test every light to high quality standards. That means we can offer you a 5-year guarantee.

## Recycling

This symbol  indicates that this product should not be treated as normal household waste and it should be recycled. John Lewis & Partners do not operate instore take back, but as members of the Distributor Take Back scheme have funded the development and upgrade of recycling facilities across the UK. Please take it to your nearest collection facility or for further details contact your local council or visit [www.recycle-more.co.uk](http://www.recycle-more.co.uk).



# PLEATED FAN WALL LIGHT USER GUIDE

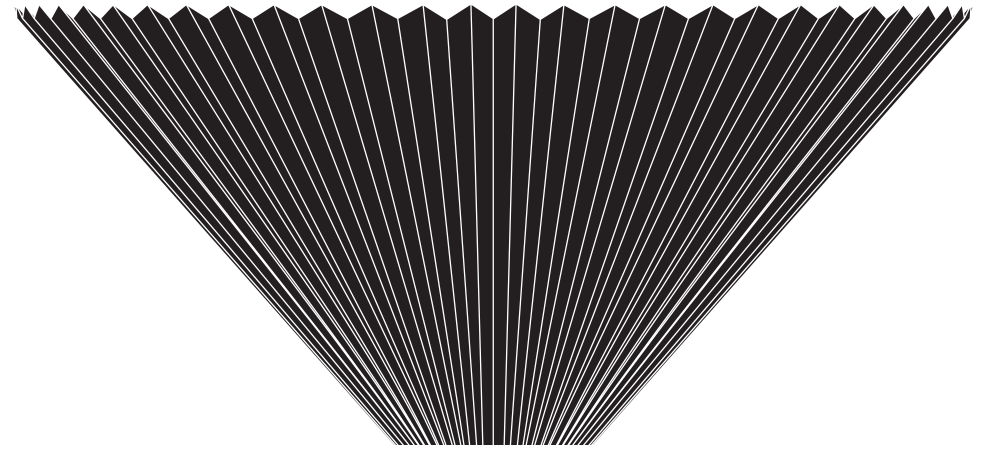

John Lewis plc  
SW1V 2QQ  
[johnlewis.com](http://johnlewis.com)

Made in China



28/03/2025

Please retain these instructions for future reference.



Product Code:  
70243105



## Getting started

Thank you for purchasing this John Lewis & Partners product. For your safety, and to make sure everything is working properly, please read the instructions carefully before use.

## Warnings

This is a Class II product and must NOT be earthed. It is recommended that this fitting is installed by a qualified electrician. Install in accordance with the IEE Wiring regulations and the Building Regulations. To prevent electrocution switch off at mains supply before installing or maintaining this fitting. Ensure other persons cannot restore the electrical supply without your knowledge. If you are in any doubt, please consult a qualified electrician. This light fitting should be connected to a 5 amp fused circuit. If replacing an existing fitting, make a note of the connections. Always use the correct type and wattage bulb. Never exceed the wattage stated. Dispose of used bulbs carefully. This product is suitable for installation on surfaces with normal flammability e.g. wood, plasterboard, masonry. It is not suitable for use on highly flammable surfaces (e.g. polystyrene, textiles). For your safety, always switch off the supply and allow the fitting to cool down before changing the lightbulb or cleaning.

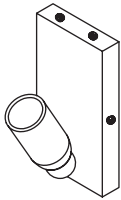
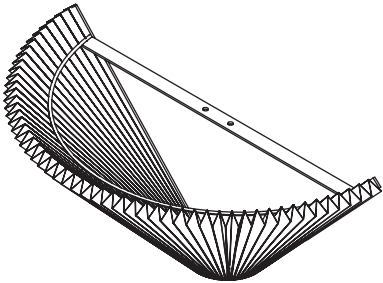
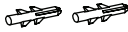
## Parts list

Description	Image	Quantity
Light fitting		x 1
Shade		x 1
Wall plugs		x 2
Screws		x 2

## Product assembly

### Step 1

Carefully unpack the carton, making sure all the parts are present before assembly. Before removing the existing fitting, carefully note the position of each set of wires.

### Step 2

Remove the fixing bracket (A) from the product by unscrewing the two side screws (B) and retain for reuse.

Ensure there is a solid mounting surface to support the weight of the light fitting. Using the fixing bracket as a template, mark the position of the mounting holes. Drill holes and fit supplied wall plugs (C) (suitable for masonry only).

Take care to avoid damaging any concealed wiring and pipes.

Fix the bracket to the wall using supplied screws (D).

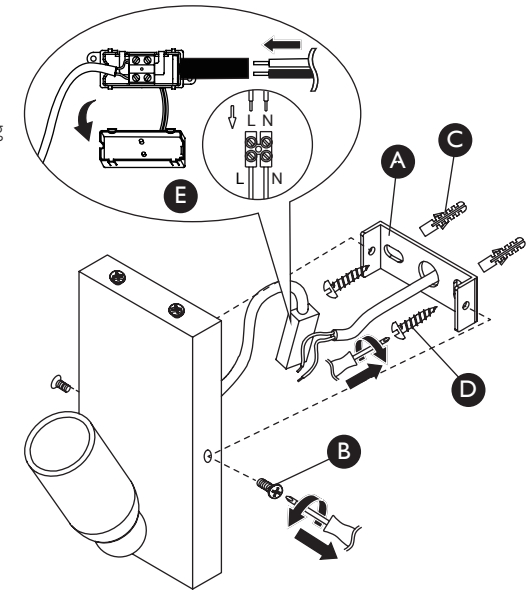

### Step 3

Having identified the household wiring from your existing light fitting, connect to the connection block (E) inside the product in the following way. Check that: You have correctly identified the house wires. The connections are tight. No loose strands have been left out of the connection block. The lid is fitted back onto the terminal block case.

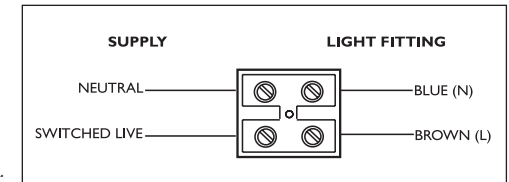

### Step 4

Making sure the lampholder is facing upwards re attach the product to the fixing bracket using the two screws removed in step 2 and tighten to secure. Take care not to trap any wiring.

### Step 5

To attach the shade (F) first remove the two small screws (G) from the top of the product. Line up the holes in the top of the shade with the holes on the product and refit the screws. Tighten to secure in place but do not overtighten.

### Step 6

Fit the recommended bulb (H) as per the details overleaf.

### Step 7

Your light is now ready for use.

