

Care Instructions

- Before assembly, unwrap all packaging materials and place the components on top of the carton or on a smooth, clean surface to prevent it from scratching
- This tabletop is made from Ceramic Printed Glass. While it has been treated with a protective lacquer during production, please avoid contact with sharp or abrasive objects
- Always ensure the Parasol Insert is in place before installing a Parasol
- When using a Parasol with this table, ensure a suitably weighted Parasol Base is used and never leave the Parasol up while unattended
- Do not sit or stand on this table
- We recommend cleaning this product periodically with warm, soapy water and a cloth or non-abrasive brush. Do not use harsh or abrasive chemicals
- To keep your product looking its best, we would always recommend covering with an LG Outdoor Furniture Cover when not being used for longer periods. Throughout the winter months either bring indoors or cover as above. Failure to do so may invalidate your warranty

Necessary Tools (Supplied)

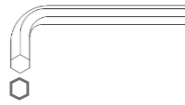

You will find a pack within this box tied to a red ribbon which contains the fittings.

WARNING – the fittings pack contains **SMALL ITEMS** which are a potential choking hazard and should be kept away from children at all times.

Assembly Requirements

Number of people required to assemble	
Approximate Assembly time	20 minutes

Assembly Instructions

Step 3

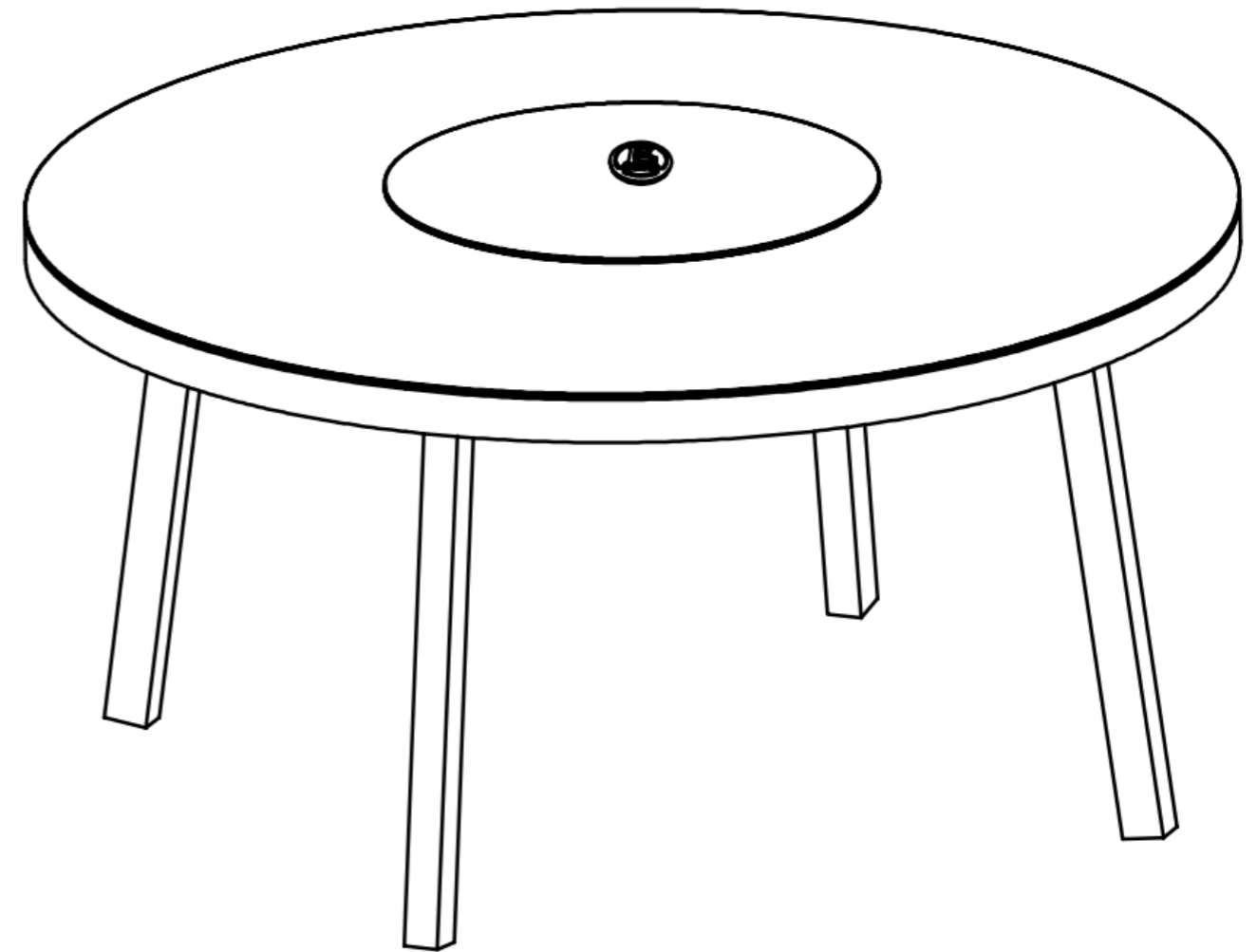

Read this leaflet in full before commencing assembly.

PLEASE ENSURE ALL FIXINGS ARE LEFT LOOSE DURING ASSEMBLY BUT ARE SECURELY TIGHTENED UPON COMPLETION.

General Warranty Conditions

The warranty applies to the original purchaser from the date of purchase and covers manufacturing faults and defects only. If an item should fail as a result of a manufacturing fault or defect under normal domestic use, the manufacturer at their discretion will repair, refinish or replace the failed item.

The manufacturer reserves the right to substitute failed items with a similar product should the model or colour no longer be available. Any replacement will be for the failed item only, not a complete set. The original warranty period is not extended in the event of a repair, refinish or replacements.

In the event of a failure, it is the customer's responsibility to return the item to the store of purchase along with a copy of the receipt. LG Outdoor will confirm that the customer has registered their warranty. Warranty specifically excludes general wear and tear, rusting of steel components and parts, corrosion, commercial use and damage caused as a result of failure to observe reasonable care, maintenance and assembly instructions for both furniture and hardware.

This product comes with a Limited Warranty which covers the following:

* 3 Year Limited Warranty - Aluminium Frames - which excludes damage to the finish caused by corrosion, scratching, pitting, fading or oxidisation

For all other components not covered by the above a standard 12-month warranty will apply

To register your warranty please visit lgoutdoor.co.uk/furniture-warranty within 28 days of purchase

LEISUREGROW

Dewmead Farm
New Inn Road
Hinworth
SG7 5HG
consumer@leisuregrow.com











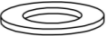

ASSEMBLY AND CARE INSTRUCTIONS

Havana 135cm Round Dining Table with Lazy Susan



**This is an important document.
Please retain for future reference.
Please keep your receipt of purchase. Please note we are unable
to process any warranty claim without proof of purchase.**

Part List Supplied

REF	IMAGE	PART	QTY	REF	IMAGE	PART	QTY
A		TABLE TOP FRAME	1	F		PARASOL BUNG	1
				G		WASHER	16
B		TABLE LEG	4	H		M6 x 20 BOLT	16
C		TABLE TOP GLASS	1	I		BOLT CAP	16
D		LAZY SUSAN BASE	1	J		ALLEN KEY	1
E		LAZY SUSAN GLASS	1	K		TOUCH UP PAINT	1

Assembly Instructions

Step 1

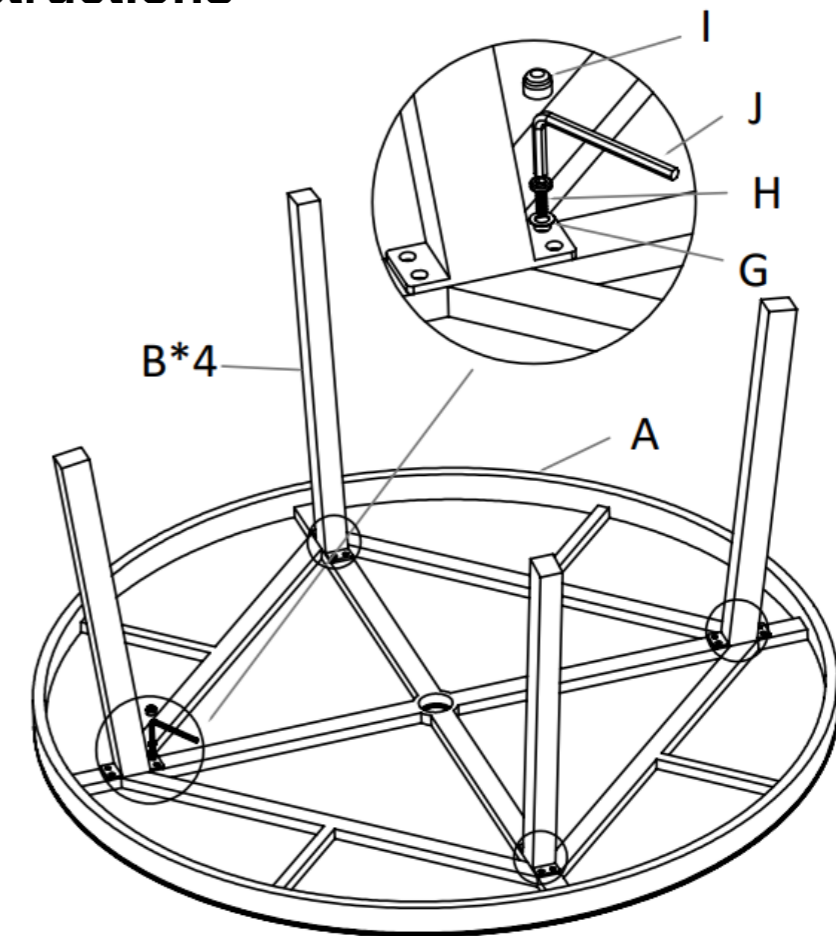

PLEASE ENSURE ALL FIXINGS ARE LEFT LOOSE DURING ASSEMBLY BUT ARE SECURELY TIGHTENED UPON COMPLETION.

Assembly Instructions

Step 2

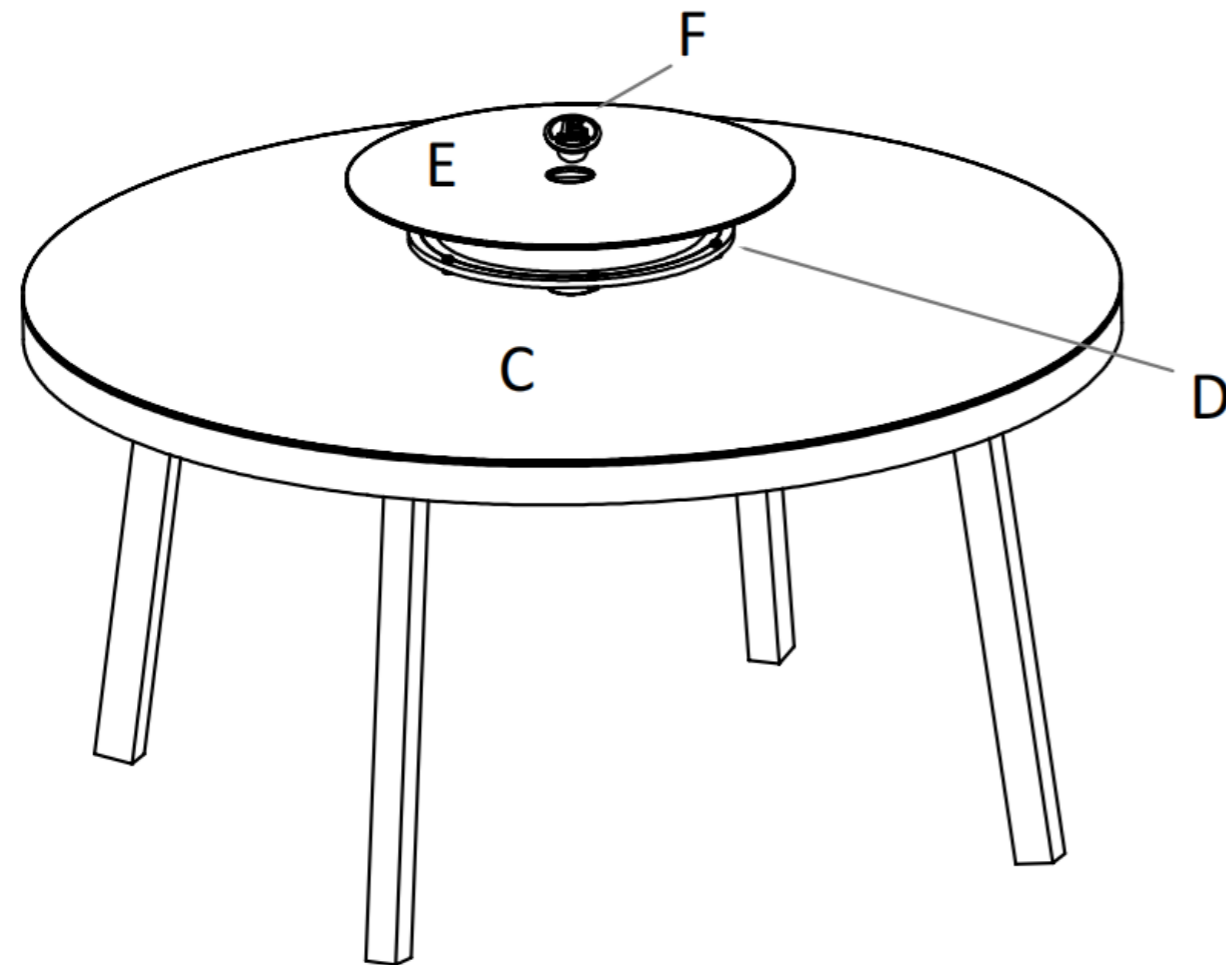

PLEASE ENSURE ALL FIXINGS ARE LEFT LOOSE DURING ASSEMBLY BUT ARE SECURELY TIGHTENED UPON COMPLETION.

Care Instructions

- Before assembly, unwrap all packaging materials and place the components on top of the carton or on a smooth, clean surface to prevent it from scratching
- Please keep sofa and any cushions away from sources of extreme heat and naked flames
- Do not stand on this product
- Do not lean back on this product. This product is only designed to be used with all four feet touching the ground
- We recommend cleaning this product periodically with warm, soapy water and a cloth or non-abrasive brush. Do not use harsh or abrasive chemicals.
- STAINSAFE Cushions should be cleaned with water only as detergents can weaken the stain-resistant coating. If detergents are used please retreat the affected area with a fabric protection spray.
- To keep your product looking its best, we would always recommend covering with an LG Outdoor Furniture Cover when not being used for longer periods. Throughout the winter months either bring indoors or cover as above. Failure to do so may invalidate your warranty

Necessary Tools (Supplied)

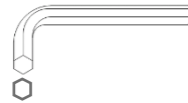

You will find a pack within this box tied to a red ribbon which contains the fittings.





WARNING – the fittings pack contains **SMALL ITEMS** which are a potential choking hazard and should be kept away from children at all times.

Assembly Requirements

Number of people required to assemble	
Approximate Assembly time	10 minutes

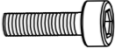
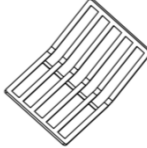
Read this leaflet in full before commencing assembly.

Part List Supplied

REF	IMAGE	PART	QTY	REF	IMAGE	PART	QTY
A		CHAIR BASE	1	D		M6x20 BOLT	4
B		CHAIR SEAT AND BACK PANEL	1	E		BOLT CAP	4
C		WASHER	4	F		ALLEN KEY	1

Assembly Instructions

Step 1

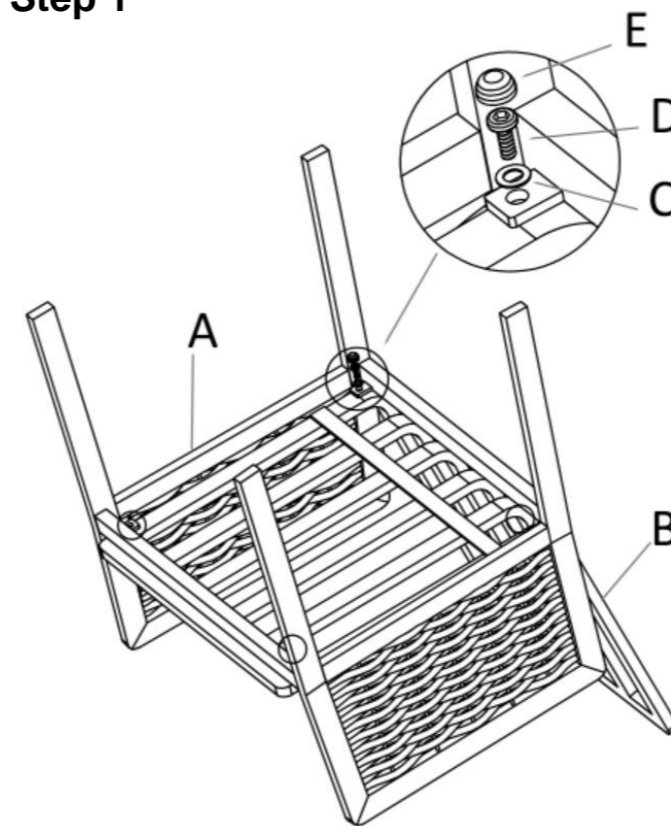

Step 2

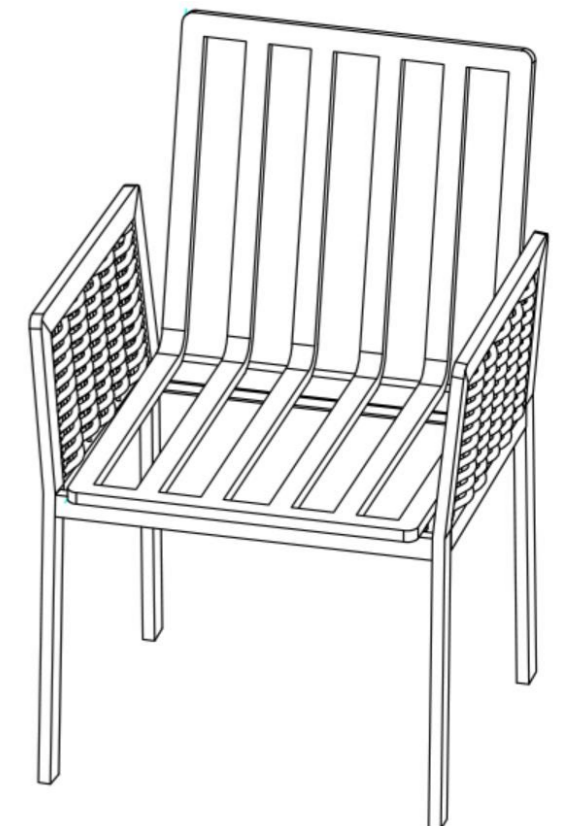

PLEASE ENSURE ALL FIXINGS ARE LEFT LOOSE DURING ASSEMBLY BUT ARE SECURELY TIGHTENED UPON COMPLETION.

General Warranty Conditions

The warranty applies to the original purchaser from the date of purchase and covers manufacturing faults and defects only. If an item should fail as a result of a manufacturing fault or defect under normal domestic use, the manufacturer at their discretion will repair, refinish or replace the failed item.

The manufacturer reserves the right to substitute failed items with a similar product should the model or colour no longer be available. Any replacement will be for the failed item only, not a complete set. The original warranty period is not extended in the event of a repair, refinish or replacements.

In the event of a failure, it is the customer's responsibility to return the item to the store of purchase along with a copy of the receipt. LG Outdoor will confirm that the customer has registered their warranty. Warranty specifically excludes general wear and tear, rusting of steel components and parts, corrosion, commercial use and damage caused as a result of failure to observe reasonable care, maintenance and assembly instructions for both furniture and hardware.

This product comes with a Limited Warranty which covers the following:

* 3 Year Limited Warranty - Aluminium Frames - which excludes damage to the finish caused by corrosion, scratching, pitting, fading or oxidisation

For all other components not covered by the above a standard 12-month warranty will apply

To register your warranty please visit lgoutdoor.co.uk/furniture-warranty within 28 days of purchase

LEISUREGROW

Dewmead Farm
New Inn Road
Hinxworth
SG7 5HG



ASSEMBLY AND CARE INSTRUCTIONS

Havana Dining Chair



**This is an important document.
Please retain for future reference.
Please keep your receipt of purchase. Please note we are unable
to process any warranty claim without proof of purchase.**

