

## Product information

- Suitable for outdoor use
- Non-dimmable
- Replacement bulbs should be the same type and rating, available from John Lewis Partners or other established brands
- Clean the fitting with a soft dry cloth. Do not use abrasive chemical cleaners as this will damage the finish
- Glass parts - Remove and wash in warm water or just use a damp cloth. Do not use abrasive materials as these will damage the finish. Take care when handling glass parts to avoid damage or injury
- Do not use this product if the shade is cracked or damaged. Do not use the product without the shade attached

## Aftercare and Troubleshooting

### You've switched on the light, but it's not working:

1. Check your power supply is switched on
2. Turn off the light and check that the bulb is inserted correctly
3. Check the bulb is still in working order

If there are technical issues with this product that you can't solve, please contact your nearest John Lewis & Partners shop or call Technical Support on 03301 230106.

## Specification

Max power: 1 x 10W  
Recommended bulb:  
10W LED E27 GLS bulb for maximum brightness.  
Lower wattages are also suitable.  
Rated input: 220 –240V, 50Hz  
Bulb not included  
IP rating: 44  
Weight: 1.2kg

## 5-year guarantee

At John Lewis & Partners we test every light to high quality standards. That means we can offer you a 5-year guarantee.

## Recycling

This symbol  indicates that this product should not be treated as normal household waste and it should be recycled. John Lewis & Partners do not operate instore take back, but as members of the Distributor Take Back scheme have funded the development and upgrade of recycling facilities across the UK. Please take it to your nearest collection facility or for further details contact your local council or visit [www.recycle-more.co.uk](http://www.recycle-more.co.uk).

John Lewis plc  
SW1V 2QQ  
[johnlewis.com](http://johnlewis.com)

Made in China



Please retain these instructions for future reference.



# HAYLE OUTDOOR WALL LIGHT USER GUIDE

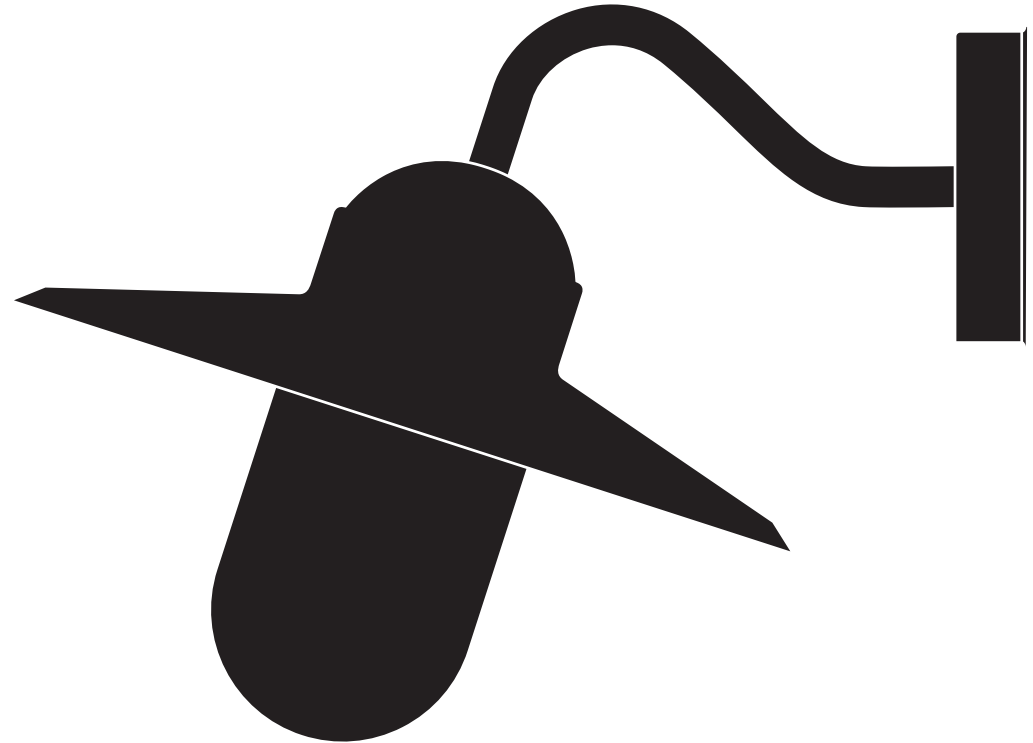

Product Code:  
70271715  
70271716  
70272005



## Getting started

Thank you for purchasing this John Lewis & Partners product. For your safety, and to make sure everything is working properly, please read the instructions carefully before use.

## Warnings

This is a Class 1 product and must be earthed. Please read these instructions carefully before commencing any work. It is recommended that this fitting is installed by a qualified electrician. Install in accordance with the IEE Wiring regulations and the Building Regulations. To prevent electric shock switch off at mains supply before installing or maintaining this fitting. Ensure other persons cannot restore the electrical supply without your knowledge. If you are in any doubt, please consult a qualified electrician. This light fitting should be connected to a 5 amp fused circuit. If replacing an existing fitting, make a note of the connections. This product is rated IP44 and is suitable for outdoor use. This product is suitable for installation on surfaces with normal flammability e.g. wood, plasterboard, masonry. It is not suitable for use on highly flammable surfaces (e.g. polystyrene, textiles). This product contains delicate parts – be careful during handling and maintenance to avoid breakage. For your safety, always switch off the supply before changing lightbulbs, cleaning or removing shades. Always take care when handling lightbulbs to avoid injury in case of breakage.

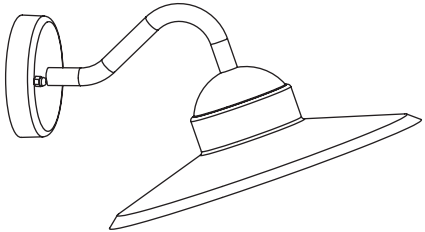
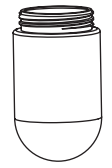
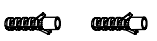
## Parts list

Description	Image	Quantity
Light fitting		x 1
Glass shade		x 1
Wall plugs		x 2
Screws		x 2

## Product assembly

### Step 1

Refer to assembly diagrams right. Carefully unpack the carton, making sure all the parts are present before assembly.

### Step 2

Remove the finials (A) and silicone rubber washers (B) from the front of the product and detach the wall back (C) and rubber seal (D).

### Step 3

Using the wall back as a template, mark the position of the mounting holes. Drill holes and fit supplied wall plugs (E) (suitable for masonry only). Make sure the wall back is correctly oriented with the drain hole at the base. Take care not to damage any wiring or pipes when drilling the holes.

### Step 4

Carefully pierce a small hole in the rubber grommet in the centre of the wall back (F) to allow the cable to pass through. Feed the incoming mains supply cable through the grommet entry hole. Secure the wall back to the wall using the screws (G) supplied. Ensure the wall is capable of holding the weight of the product.

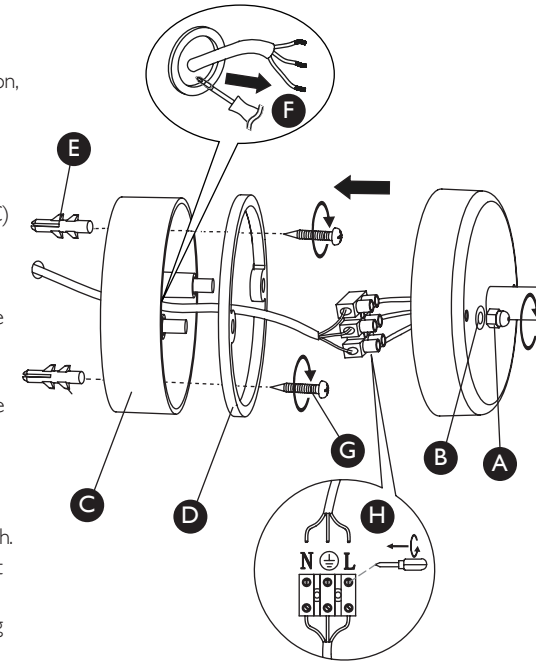

### Step 5

Having identified the household wiring from your existing light fitting, connect to the connection block (H) inside the product in the following way: Check that: You have correctly identified the house wires. The connections are tight. No loose strands have been left out of the connection block.

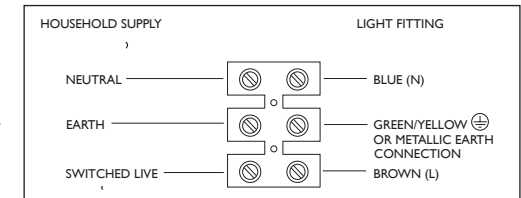

### Step 6

Fit the rubber seal and re-attach the product to the wall back ensuring not to trap any wiring. Make sure the product is correctly orientated with the lampholder facing downwards and the rubber seal is securely fixed to maintain moisture protection.

### Step 7

Fit the recommended bulb (I) as per the details overleaf.

### Step 8

Attach the glass shade (J) by screwing onto the lampholder in a clockwise direction. Tighten with light pressure.

### Step 9

Turn on the power and test.

