

Product information

- Indoor use only
- Non dimmable
- Clean the fitting with a soft dry cloth. Do not use abrasive chemical cleaners as this will damage the finish
- Glass parts - Remove and wash in warm water or just use a damp cloth. Do not use abrasive materials as these will damage the finish.

Aftercare and Troubleshooting

If there are technical issues with this product that you can't solve, please contact your nearest John Lewis & Partners shop or call Technical Support on 03301 230106.

Specification

Max power: 25W
Rated input: 220 –240V, 50Hz
IP rating: 20
Weight: 2.15kg
Lumen output: 1900
Colour temperature: Warm white (3000K)
This product contains a light source of energy efficiency class F
For further information please visit: www.lighting-info.co.uk/59904

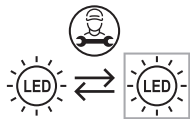

Replaceable (LED only) light source by a professional

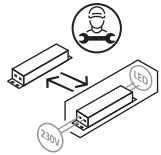

Replaceable control gear by a professional

5-year guarantee

At John Lewis & Partners we test every light to high quality standards. That means we can offer you a 5-year guarantee.

Recycling

This symbol  indicates that this product should not be treated as normal household waste and it should be recycled. John Lewis & Partners do not operate instore take back, but as members of the Distributor Take Back scheme have funded the development and upgrade of recycling facilities across the UK. Please take it to your nearest collection facility or for further details contact your local council or visit www.recycle-more.co.uk.

John Lewis plc
SW1V 2QQ
johnlewis.com

Made in China



05/09/2024

Please retain these instructions for future reference.



TAMEO 5 ARM LED SEMI FLUSH CEILING LIGHT USER GUIDE

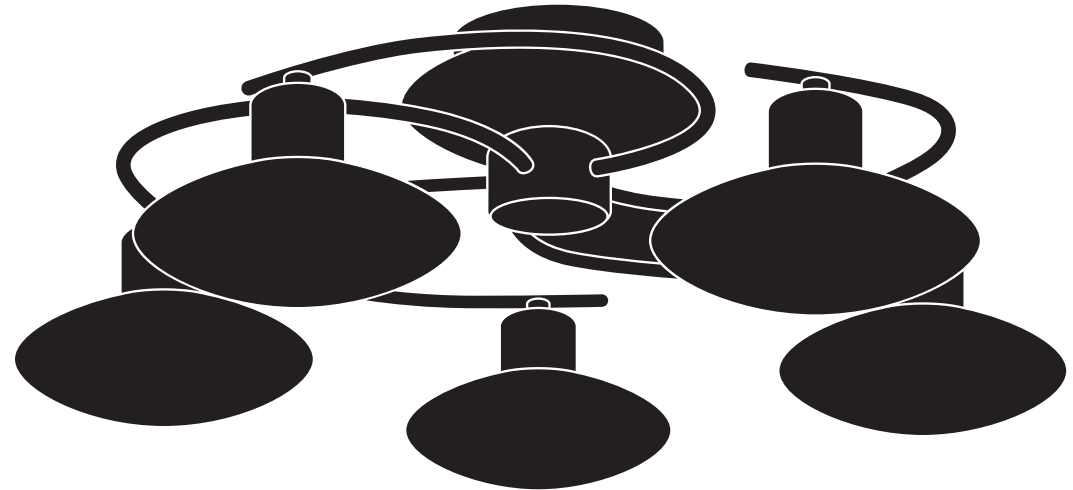

Product Code:
70130309
70130310



Getting started

Thank you for purchasing this John Lewis & Partners product. For your safety, and to make sure everything is working properly, please read the instructions carefully before use.

Warnings

This is a Class 1 product and must be earthed. It is recommended that this fitting is installed by a qualified electrician. Install in accordance with the IEE Wiring regulations and the Building Regulations. To prevent electrocution switch off at mains supply before installing or maintaining this fitting. Ensure other persons cannot restore the electrical supply without your knowledge. If you are in any doubt, please consult a qualified electrician. This light fitting should be connected to a 5 amp fused circuit. If replacing an existing fitting, make a note of the connections. This product is suitable for installation on surfaces with normal flammability e.g. wood, plasterboard, masonry. It is not suitable for use on highly flammable surfaces (e.g. polystyrene, textiles). This product contains delicate parts – be careful during handling and maintenance to avoid breakage. For your safety, always switch off the supply and allow the fitting to cool down before cleaning or adjusting.

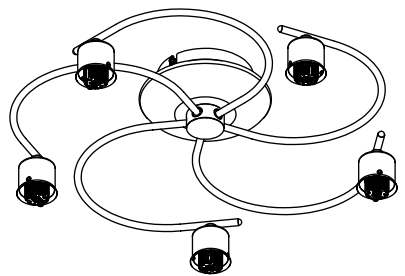
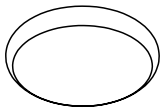
Parts list

Description	Image	Quantity
Light fitting		x 1
Glass shades		x 5
Wall plugs		x 2
Screws		x 2

Product assembly

Step 1

Carefully unpack the carton, making sure all the parts are present before assembly. Before removing the existing fitting, carefully note the position of each set of wires.

Step 2

Remove the fixing bracket (A) from the product by loosening the two side screws (B). Ensure there is a solid mounting surface to support the weight of the light fitting. Using the fixing bracket as a template, mark the position of the mounting holes. Drill holes and fit supplied wall plugs (C) (suitable for masonry only). Take care to avoid damaging any concealed wiring and pipes. Fix the bracket to the ceiling using supplied screws (D).

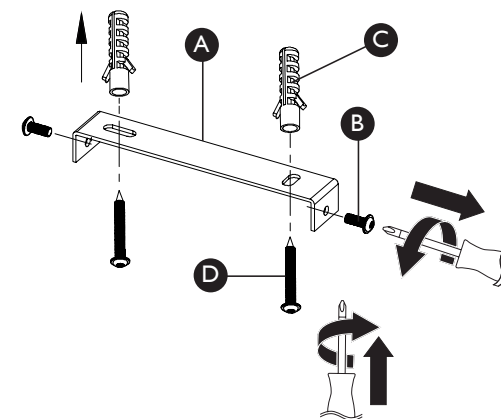

Step 3

Having identified the household wiring from your existing light fitting, connect to the connection block inside the product in the following way. Check that:

You have correctly identified the house wires.

The connections are tight.

No loose strands have been left out of the connection block.

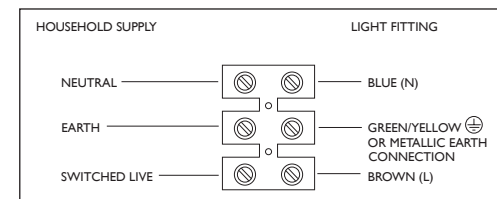

Step 4

This product has "L" shaped fixing slots to allow easy fixing to the fixing bracket. Locate the "L" slots (E) around the small screws (B) on the fixing bracket (A). Rotate the ceiling cover to attach the product to the bracket. Tighten the screws to secure. Take care not to trap any wiring.

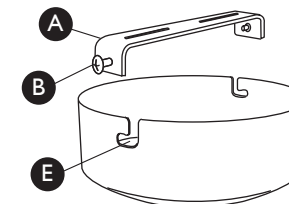

Step 5

Screw the shades (F) into the cup on each arm.

Tighten with light pressure.

Step 6

Your light is now ready for use.

