

EN User Manual | **Microwave combi-oven**

KMK365060M

KMX365060B

KMX365060M



Welcome to AEG! Thank you for choosing our appliance.



Get usage advice, brochures, trouble shooter, service and repair information:
www.aeg.com/support

Subject to change without notice.

CONTENTS

1. SAFETY INFORMATION.....	2
2. SAFETY INSTRUCTIONS.....	5
3. PRODUCT DESCRIPTION.....	8
4. CONTROL PANEL.....	8
5. BEFORE FIRST USE.....	9
6. DAILY USE.....	9
7. ADDITIONAL FUNCTIONS.....	14
8. CLOCK FUNCTIONS.....	15
9. USING THE ACCESSORIES.....	16
10. HINTS AND TIPS.....	17
11. CARE AND CLEANING.....	19
12. TROUBLESHOOTING.....	20
13. ENERGY EFFICIENCY.....	21
14. ENVIRONMENTAL CONCERNS.....	21

1. ⚠ SAFETY INFORMATION

Before the installation and use of the appliance, carefully read the supplied instructions. The manufacturer is not responsible for any injuries or damage that are the result of incorrect installation or usage. Always keep the instructions in a safe and accessible location for future reference.

1.1 Children and vulnerable people safety

- This appliance can be used by children aged from 8 years and above and persons with reduced physical, sensory or mental capabilities or lack of experience and knowledge if they have been given supervision or instruction concerning the use of the appliance in a safe way and understand the hazards involved. Children of less than 8 years of age and persons with very extensive and complex disabilities shall be kept away from the appliance unless continuously supervised.

- Children should be supervised to ensure that they do not play with the appliance.
- Keep all packaging away from children and dispose of it appropriately.
- **WARNING:** The appliance and its accessible parts become hot during use. Keep children and pets away from the appliance when in use and when cooling down.
- If the appliance has a child safety device, it should be activated.
- Children shall not carry out cleaning and user maintenance of the appliance without supervision.

1.2 General Safety

- This appliance is for cooking purposes only.
- This appliance is designed for single household domestic use in an indoor environment.
- This appliance may be used in, offices, hotel guest rooms, bed & breakfast guest rooms, farm guest houses and other similar accommodation where such use does not exceed (average) domestic usage levels.
- Only a qualified person must install this appliance and replace the cable.
- Do not use the appliance before installing it in the built-in structure.
- Disconnect the appliance from the power supply before carrying out any maintenance.
- If the supply cord is damaged, it must be replaced by the manufacturer, its Authorised Service Centre or similarly qualified persons to avoid an electrical hazard.
- **WARNING:** Ensure that the appliance is switched off before replacing the lamp to avoid the possibility of electric shock.
- **WARNING:** The appliance and its accessible parts become hot during use. Care should be taken to avoid touching heating elements or the surface of the appliance cavity.
- Always use oven gloves to remove or insert accessories or ovenware.

- Do not activate the microwave function when the appliance is empty. Metal parts inside the cavity can create electric arcing.
- Metallic containers for food and beverages are not allowed during microwave cooking. This requirement is not applicable if the manufacturer specifies size and shape of metallic containers suitable for microwave cooking.
- **WARNING:** If the door or door seals are damaged, the appliance must not be operated until it has been repaired by a qualified person.
- **WARNING:** Only a qualified person can carry out any service or repair operation that involves the removal of a cover which gives protection against exposure to microwave energy.
- **WARNING:** Do not heat liquids and other foods in sealed containers. They are liable to explode.
- Use only utensils that are suitable for use in microwave ovens.
- When heating food in plastic or paper containers, observe the appliance due to the possibility of ignition.
- The appliance is intended for heating food and beverages. Drying of food or clothing and heating of warming pads, slippers, sponges, damp cloth and similar may lead to risk of injury, ignition or fire.
- If smoke is emitted, switch off or unplug the appliance and keep the door closed in order to stifle any flames.
- Microwave heating of beverages can result in delayed eruptive boiling. Care must be taken when handling the container.
- The contents of feeding bottles and baby food jars shall be stirred or shaken and the temperature checked before consumption, in order to avoid burns.
- Eggs in their shell and whole hard-boiled eggs should not be heated in the appliance since they may explode, even after microwave heating has ended.

- To remove the shelf supports first pull the front of the shelf support and then the rear end away from the side walls. Install the shelf supports in the opposite sequence.
- The appliance should be cleaned regularly and any food deposits removed.
- Do not use a steam cleaner to clean the appliance.
- Do not use harsh abrasive cleaners or sharp metal scrapers to clean the glass door since they can scratch the surface, which may result in shattering of the glass.
- Failure to maintain the appliance in a clean condition could lead to deterioration of the surface that could adversely affect the life of the appliance and possibly result in a hazardous situation.

2. SAFETY INSTRUCTIONS

2.1 Installation

WARNING!

Only a qualified person must install this appliance.

- Remove all the packaging.
- Do not install or use a damaged appliance.
- Follow the installation instructions supplied with the appliance.
- Always take care when moving the appliance as it is heavy. Always use safety gloves and enclosed footwear.
- Do not pull the appliance by the handle.
- Install the appliance in a safe and suitable place that meets installation requirements.
- Keep the minimum distance from other appliances and units.
- Before mounting the appliance, check if the appliance door opens without restraint.
- The appliance is equipped with an electric cooling system. It must be operated with the electric power supply.
- The built-in unit must meet the stability requirements of DIN 68930.

Cabinet minimum height (Cabinet under the worktop minimum height)	444 (460) mm
---	--------------

Cabinet width	560 mm
Cabinet depth	550 (550) mm
Height of the front of the appliance	455 mm
Height of the back of the appliance	440 mm
Width of the front of the appliance	595 mm
Width of the back of the appliance	559 mm
Depth of the appliance	567 mm
Built in depth of the appliance	546 mm
Depth with open door	882 mm
Ventilation opening minimum size. Opening placed on the bottom rear side	560x20 mm
Mains supply cable length. Cable is placed in the right corner of the back side	1500 mm
Mounting screws	3.5x25 mm

2.2 Electrical connection

WARNING!

Risk of fire and electric shock.

- All electrical connections should be made by a qualified electrician.
- The appliance must be earthed.
- Make sure that the parameters on the rating plate are compatible with the electrical ratings of the mains power supply.
- Always use a correctly installed shockproof socket.
- Do not use multi-plug adapters and extension cables.
- Make sure not to cause damage to the mains plug and to the mains cable. Should the mains cable need to be replaced, this must be carried out by our Authorised Service Centre.
- Do not let mains cables touch or come near the appliance door or the niche below the appliance, especially when it operates or the door is hot.
- The shock protection of live and insulated parts must be fastened in such a way that it cannot be removed without tools.
- Connect the mains plug to the mains socket only at the end of the installation. Make sure that there is access to the mains plug after the installation.
- If the mains socket is loose, do not connect the mains plug.
- Do not pull the mains cable to disconnect the appliance. Always pull the mains plug.
- Use only correct isolation devices: line protecting cut-outs, fuses (screw type fuses removed from the holder), earth leakage trips and contactors.
- The electrical installation must have an isolation device which lets you disconnect the appliance from the mains at all poles. The isolation device must have a contact opening width of minimum 3 mm.
- This appliance is supplied only with a main cable.

2.3 Use

WARNING!

Risk of injury, burns and electric shock or explosion.

- Do not change the specification of this appliance.
- Make sure that the ventilation openings are not blocked.
- Do not let the appliance stay unattended during operation.
- Deactivate the appliance after each use.
- Be careful when you open the appliance door while the appliance is in operation. Hot air can release.
- Do not operate the appliance with wet hands or when it has contact with water.
- Do not apply pressure on the open door.
- Do not use the appliance as a work surface or as a storage surface.
- Open the appliance door carefully. The use of ingredients with alcohol can cause a mixture of alcohol and air.
- Do not let sparks or open flames to come in contact with the appliance when you open the door.
- Always use glass and jars approved for preserving purposes.
- Do not put flammable products or items that are wet with flammable products in, near or on the appliance.
- Do not use microwave function to preheat the appliance.

WARNING!

Risk of damage to the appliance.

- To prevent damage or discoloration to the enamel:
 - do not put aluminium foil directly on the bottom of cavity of the appliance.
 - do not put water directly into the hot appliance.
 - do not keep moist dishes and food in the appliance after you finish the cooking.
 - be careful when you remove or install the accessories.
- Discoloration of the enamel or stainless steel has no effect on the performance of the appliance.

- Use a deep pan for moist cakes. Fruit juices cause stains that can be permanent.
- Always cook with the appliance door closed.
- If the appliance is installed behind a furniture panel (e.g. a door) make sure the door is never closed when the appliance operates. Heat and moisture can build up behind a closed furniture panel and cause subsequent damage to the appliance, the housing unit or the floor. Do not close the furniture panel until the appliance has cooled down completely after use.

2.4 Care and cleaning

WARNING!

Risk of injury, fire, or damage to the appliance.

- Before maintenance, deactivate the appliance and disconnect the mains plug from the mains socket.
- Make sure the appliance is cold. There is the risk that the glass panels can break.
- Replace immediately the door glass panels when they are damaged. Contact the Authorised Service Centre.
- Be careful when you remove the door from the appliance. The door is heavy!
- Make sure the cavity and the door are wiped dry after each use. Steam produced during the operation of the appliance condensates on cavity walls and can cause corrosion.
- Clean regularly the appliance to prevent the deterioration of the surface material.
- Fat and food remaining in the appliance can cause fire and electric arcing when the microwave function operates.
- Clean the appliance with a moist soft cloth. Use only neutral detergents. Do not use abrasive products, abrasive cleaning pads, solvents or metal objects.
- If you use an oven spray, follow the safety instructions on its packaging.

2.5 Glassware use

Handling your glassware without an appropriate degree of care could result in breakage, chipping, cracking or severe scratching:

- Do not spill cold water or other liquids on the glassware because a sudden temperature drop may cause immediate breakage of the glass. Broken glass pieces may be extremely sharp and difficult to locate.
- Do not place hot glassware on a wet or cool surface, directly on countertop or metal surface, or in sink; or handle hot glassware with wet cloth.
- Do not use or repair any glassware that is chipped, cracked or severely scratched.
- Do not drop or hit glassware against a hard object or strike utensils against it.
- Do not heat empty or nearly empty glassware in microwave, or overheat oil or butter in microwave (use minimum amount of cooking time).

Allow hot glassware to cool on a cooling rack, a potholder or a dry cloth. Make sure that the glassware is cool enough before washing, refrigerating or freezing.

Avoid handling hot glassware (including ware with silicone gripping surfaces) without dry potholders.

Avoid microwave misuse (i.e. running the oven without any load or small load).

2.6 Internal lighting

WARNING!

Risk of electric shock.

- Concerning the lamp(s) inside this product and spare part lamps sold separately: These lamps are intended to withstand extreme physical conditions in household appliances, such as temperature, vibration, humidity, or are intended to signal information about the operational status of the appliance. They are not intended to be used in other applications and are not suitable for household room illumination.
- This product contains a light source of energy efficiency class G.
- Use only lamps with the same specifications.

2.7 Service

- To repair the appliance contact the Authorised Service Centre.

- Use original spare parts only.

2.8 Disposal



WARNING!

Risk of injury or suffocation.

- Contact your municipal authority for information on how to dispose of the appliance.
- Disconnect the appliance from the mains supply.
- Cut off the mains electrical cable close to the appliance and dispose of it.

3. PRODUCT DESCRIPTION

3.1 General overview

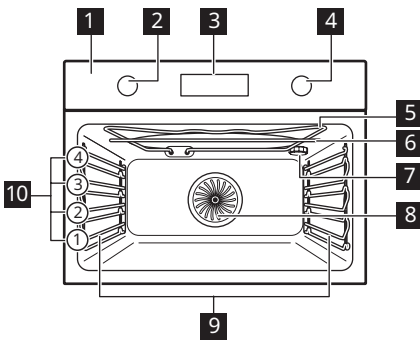

- 1** Control panel
- 2** Knob for the heating functions
- 3** Display
- 4** Control knob
- 5** Heating element
- 6** Microwave generator
- 7** Lamp
- 8** Fan
- 9** Shelf support, removable
- 10** Shelf positions

3.2 Accessories

- **Wire shelf**
For cake tins, overproof dishes, roast dishes, cookware/ dishes.
- **Baking tray**
For moist cakes, baked items, bread, large roasts, frozen meals and to catch dripping

liquids, e.g. fat when roasting food on wire shelf.

- **Microwave bottom glass plate**
To prepare food in microwave mode.



4. CONTROL PANEL

4.1 Turning the appliance on and off

To turn on the appliance:

1. Press the knob. The knob comes out.
 2. Turn the knob for the heating functions to select a function.
 3. Turn the control knob to adjust settings.
- To turn off the appliance: turn the knob for the heating functions to the .

4.2 Control panel overview

	Press to set: Clock functions.
	Press to set: Fast Heat Up.
	Press to turn on or to turn off the oven lamp.
WATT	Press to set: Microwave power.
OK	Press to confirm your selection.

4.3 Display indicators

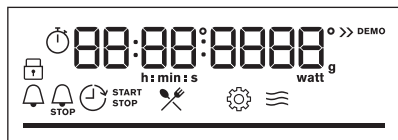

Display with key functions.



The appliance is locked.



Enter the menu and select the icon to open: Assisted Cooking.



Enter the menu and select the icon to open: Settings



Microwave function is turned on.



Minute minder is turned on.



End time is turned on.



Time Delayed Start is turned on.



Uptimer is turned on.



For temperature or time. The bar is fully red when the appliance reaches the set temperature.

5. BEFORE FIRST USE



WARNING!

Refer to Safety chapters.

5.1 Setting the time

After the first connection to the mains, wait until the display shows: "00:00".

1. Turn the control knob to set the time.
2. Press OK.

5.2 Initial cleaning

1. Remove all accessories and removable shelf supports from the appliance.
2. Clean the appliance and the accessories only with a microfibre cloth, warm water and a mild detergent.

3. Put the accessories and removable shelf supports back to their initial position.

5.3 Initial preheating

Before the first use, set the clock and preheat the empty appliance.

1. Remove all accessories and removable shelf supports from the appliance.
2. Set the function . Set the maximum temperature.

Let the appliance operate for 1 h.

Turn off the appliance and wait until it is cold. The appliance can emit an odour and smoke. Make sure that the airflow in the room is sufficient.

6. DAILY USE



WARNING!

Refer to Safety chapters.

6.1 Heating functions

Standard heating functions



True Fan Cooking

To bake on up to two shelf positions at the same time and to dry food. Set the temperature 20 - 40 °C lower than for Conventional Cooking.



Conventional Cooking

To bake and roast food on one shelf position.



Pizza Function

To bake pizza. To make intensive browning and a crispy bottom.



Turbo Grilling

To roast large meat joints or poultry with bones on one shelf position. To bake gratins and to brown.



Menu

To enter the Menu: Assisted Cooking, Set-tings.

Microwave combi functions



Turbo Grilling + MW

To roast large pieces of meat on one shelf position. To bake gratins and to brown. The function with MW boost, power range: 100 - 600 W.



True Fan Cooking + MW

Baking on one shelf position. The function with MW boost, power range: 100 - 600 W.

Microwave functions



Defrost

Defrosting meat, fish, cakes, power range: 100 - 200 W



Reheat

Heating up pre-prepared meals, power range: 300 - 700 W



Microwave

Heating up, cooking, power range: 100 - 1000 W

6.2 Setting: Heating functions

1. Turn the knob for the heating functions to select a heating function.
2. Turn the control knob to set the temperature.
3. Press **OK**.

- press and hold to turn on the function: Fast Heat Up. It is available for some oven functions.

6.3 Setting: Microwave functions

1. Remove all accessories.
2. Insert microwave bottom glass plate.
3. Insert the food into the appliance.
4. Turn the knob for the heating functions to select the microwave function.
5. Press **OK** to start with default settings.

The display shows: duration and microwave power.

6. Turn the control knob to adjust the duration. Press **OK**.
7. Press **WATT**. Turn the control knob to adjust the microwave power. Press **OK**. You can adjust settings while cooking.

The maximum time of microwave functions depends on microwave power you set:

Microwave power (W)	Maximum time (min)
100 - 600	59:55
> 600	7



If you open the door, the microwave function stops. To start it again, close the door. Press **OK**.

6.4 Setting: Microwave combi functions



1. Remove all accessories.
2. Insert microwave bottom glass plate. Place the food on the microwave bottom glass plate.
3. Turn the knob for the heating functions to select the microwave combi function.
4. Turn the control knob to adjust the temperature.
5. Press **WATT**. Turn the control knob to adjust the microwave power. Press **OK**.
6. Press **OK** to start the function.
7. Turn the knob for the heating functions to the off position to turn off the appliance. You can adjust settings while cooking.

6.5 Setting: Assisted Cooking





Assisted Cooking submenu consists of a set of additional functions and dishes with recommended cooking functions, temperatures and times. You can adjust the time and the temperature during cooking.

When the function ends, check if the food is ready.

For some of the dishes you can also cook with Weight Automatic.

1. Turn the knob for the heating functions to  to enter Menu.
2. Select . Press **OK**.
3. Turn the control knob to select a number of the dish. Press **OK**.
4. Place the food inside the appliance. Press **OK**.







Menu: Assisted Cooking



















Legend	
	Weight Automatic available.
	Function with microwave power. Use microwave safe accessory.
	Preheat the appliance before you start cooking.
	Shelf level.































The display shows **F** and a **number** of the function that you can check in the table.

Heating function		Description
F1	Grill	To grill thin pieces of food and to toast bread.
F2	Bottom Heat	To bake cakes with crispy bottom and to preserve food.
F3	Frozen Foods	To make convenience food crispy, e.g. french fries, potato wedges or spring rolls.
F4	Conventional Cooking + MW	Baking and roasting food on one shelf position. The function with MW boost, power range: 100 - 600 W.
F5	Grill + MW	To grill and brown food on one shelf position. The function with MW boost, power range: 100 - 600 W.



The display shows **P** and a **number** of the dish that you can check in the table.

Dish	Weight	Shelf level / Accessory
P1 Roast Beef, rare		
P2 Roast Beef, medium	1 - 1.5 kg; 4 - 5 cm thick pieces	 1; baking tray Fry the meat for a few minutes on a hot pan. Insert to the appliance.
P3 Roast Beef, well done		
P4 Steak, medium	180 - 220 g per piece; 3 cm thick slices	  2; roasting dish on wire shelf Fry the meat for a few minutes on a hot pan. Insert to the appliance.
P5 Beef roast / braised (prime rib, top round, thick flank)	1.5 - 2 kg	  1; roasting dish on wire shelf
P6 Roast Beef, rare (slow cooking)		
P7 Roast Beef, medium (slow cooking)	1 - 1.5 kg; 4 - 5 cm thick pieces	 1; baking tray Fry the meat for a few minutes on a hot pan. Insert to the appliance.
P8 Roast Beef, well done (slow cooking)		

	Dish	Weight	Shelf level / Accessory
P9	Fillet of beef, rare (slow cooking)		
P10	Fillet of beef, medium (slow cooking)	0,5 - 1.5 kg; 5 - 6 cm thick pieces	 1; baking tray Fry the meat for a few minutes on a hot pan. Insert to the appliance.
P11	Fillet of beef, done (slow cooking)		
P12	Veal roast (e.g. shoulder)	0.8 - 1.5 kg; 4 cm thick pieces	  1; roasting dish on wire shelf Fry the meat for a few minutes on a hot pan. Add liquid. Insert to the appliance.
P13	Pork roast neck or shoulder	1.5 kg	  1; ceramic or glass casserole dish on wire shelf , MW suitable Turn the meat after half of the cooking time.
P14	Pulled pork (slow cooking)	1.5 - 2 kg	 1; baking tray Turn the meat after half of the cooking time to get an even browning.
P15	Pork loin, fresh	1 - 1.5 kg; 5 - 6 cm thick pieces	 1; roasting dish on wire shelf
P16	Pork spare ribs	2 - 3 kg; use raw, 2 - 3 cm thin spare ribs	 2; deep pan Add liquid to cover the bottom of a dish. Turn the meat after half of the cooking time.
P17	Lamb leg with bones	1.5 - 2 kg; 7 - 9 cm thick pieces	 1; roasting dish on baking tray Fry the meat for a few minutes on a hot pan. Add liquid. Turn the meat after half of the cooking time.
P18	Whole chicken	1 - 1.1 kg; fresh	  1; ceramic or glass casserole dish on wire shelf , MW suitable Put the chicken breast-side down and turn it over after half of the cooking time.
P19	Half chicken	0.5 - 0.8 kg	 2; baking tray
P20	Chicken breast	180 - 200 g per piece	  1; casserole dish on wire shelf Fry the meat for a few minutes on a hot pan.
P21	Chicken legs, fresh	250 - 400 g	 2; baking tray If you marinated chicken legs first, set lower temperature and cook them longer.
P22	Duck, whole	1.5 - 2.5 kg	  1; roasting dish on wire shelf Put the meat on roasting dish. Turn the duck after half of the cooking time.
P23	Goose, breast	1kg	 1; roasting dish on wire shelf Turn the goose after half of the cooking time.
P24	Meat loaf	1 kg	 1; wire shelf

	Dish	Weight	Shelf level / Accessory
P25	Whole fish, grilled	0.5 - 1 kg per fish	 1; baking tray Fill the fish with butter and use your favourite spices and herbs.
P26	Fish fillet	-	  2; casserole dish on wire shelf
P27	Cheesecake	-	 1;  28 cm springform tin on wire shelf
P28	Apple cake	-	 2; baking tray
P29	Apple tart	-	 1; pie form on wire shelf
P30	Apple pie	-	 1;  22 cm pie form on wire shelf
P31	Brownies	2 kg of dough	 2; deep pan
P32	Chocolate muffins	-	 2; muffin tray on wire shelf
P33	Loaf cake	-	 1; loaf pan on wire shelf
P34	Baked potatoes	1 kg	 1; baking tray Put the whole potatoes with skin on baking tray.
P35	Wedges	1 kg	 2; baking tray lined with baking paper Cut potatoes into pieces.
P36	Grilled mixed vegetables	1 - 1.5 kg	 2; baking tray lined with baking paper Cut the vegetables into pieces.
P37	Croquettes, frozen	0.5 kg	 2; baking tray
P38	Pommes, frozen	0.75 kg	 2; baking tray
P39	Meat / vegetable lasagna with dry pasta sheets	1 - 1.5 kg	  1; ceramic or glass casserole dish on wire shelf , MW suitable
P40	Potato gratin (raw potatoes)	1.1 kg	  2; ceramic or glass casserole dish on wire shelf , MW suitable Rotate the dish after half of the cooking time.
P41	Pizza fresh, thin	-	  1; baking tray lined with baking paper
P42	Pizza fresh, thick	-	  1; baking tray lined with baking paper
P43	Quiche	-	 1; baking tin on wire shelf
P44	Baguette / Ciabatta / White bread	0.8 kg	  1; baking tray lined with baking paper More time needed for white bread.
P45	Whole grain / Rye / Dark bread	1 kg	  1; baking tray lined with baking paper / loaf pan on wire shelf

6.6 Changing: Settings

1. Turn the knob for the heating functions to  to enter Menu.
2. Select . Press **OK**.
3. Turn the control knob to select the setting. Press **OK**.
4. Adjust the value. Press **OK**.
Turn the knob for the heating functions to the off position to exit Menu.

Menu: Settings

Setting	Value
01 Time of day	Change

Setting	Value
02 Display brightness	1 - 5
03 Key tones	1 - Beep, 2 - Click, 3 - Sound off
04 Buzzer volume	1 - 4
05 Uptimer	On / Off
06 Light	On / Off
07 Demo mode	Activation code: 2468
08 Software version	Check
09 Reset all settings	Yes / No

7. ADDITIONAL FUNCTIONS

7.1 Lock

This function prevents an accidental change of the appliance function.

Turn it on when the appliance works - the set cooking continues, the control panel is locked.

Turn it on when the appliance is off - it cannot be turned on, the control panel is locked.



 **OK** - press and hold to turn on the function.

A signal sounds.  - flashes 3 times when the lock is turned on.

 **OK** - press and hold to turn off the function.

7.2 Automatic switch-off

For safety reasons, if the heating function is active and no settings are changed, the appliance will turn off automatically after a certain period of time.

 (°C)	 (h)
30 - 115	12.5
120 - 195	8.5
200 - 230	5.5

If you intend to run a heating function for a duration exceeding the automatic switch-off time, set the cooking length. Refer to the 'Clock functions' chapter.





The Automatic switch-off does not work with the functions: Light, Time Delayed Start.

7.3 Cooling fan

When the appliance operates, the cooling fan turns on automatically to keep the surfaces of the appliance cool. If you turn off the appliance, the cooling fan can continue to operate until the appliance cools down.



8. CLOCK FUNCTIONS

8.1 Clock functions description

 Time of day	To set the clock that displays the current time.
 Minute minder	To set a countdown timer. When the timer ends, the signal sounds. This function has no effect on the operation of the oven.
 Cooking time	To set cooking duration. When the timer ends, the signal sounds and the heating function will automatically turn off.
 Time Delayed Start	To postpone the start and / or end of cooking.
 Uptimer	To show how long the appliance operates. Maximum is 23 h 59 min. This function has no effect on the operation of the oven.

Minute minder, Time Delayed Start and Cooking time are available for: True Fan Cooking, Conventional Cooking, Turbo Grilling, Pizza Function. **Cooking time** is also available for Turbo Grilling + MW, True Fan Cooking + MW.

8.2 Setting: Time of day

1. Turn the knob for the heating functions to  to enter Menu.
2. Turn the control knob to select  / Time of day.
3. Turn the control knob to set the clock.
4. Press **OK**.

8.3 Setting: Minute minder

1. Press .

The display shows: 0:00 and .

2. Turn the control knob to set the Minute minder.
3. Press **OK**. The timer starts counting down immediately.

When the time ends, press **OK** and turn the knob for the heating functions to the off position.

8.4 Setting: Cooking time

1. Turn the knob to select the heating function and set the temperature.
2. Press  repeatedly.

The display shows: 0:00 and .

3. Turn the control knob to set the Cooking time.
4. Press **OK**.

The timer starts counting down immediately.

When the time ends, press **OK** and turn the knob for the heating functions to the off position.

8.5 Setting: Time Delayed Start

1. Turn the knobs to select the heating function and set the temperature.
2. Press  repeatedly.

The display shows: the time of day  START.



3. Turn the control knob to set the start time.
4. Press **OK**.

The display shows: --:--  STOP.

5. Turn the control knob to set the end time.
 6. Press **OK**.
- The timer starts counting down at a set start time.

When the time ends, press **OK** and turn the knob for the heating functions to the off position.

8.6 Setting: Uptimer

1. Turn the knob for the heating functions to  to enter Menu.
2. Turn the control knob to select  / Uptimer. Refer to "Daily Use" chapter, Menu: Settings.
3. Press **OK**.

4. Turn the control knob to turn the function on and off.

5. Press OK.

9. USING THE ACCESSORIES

WARNING!

Refer to Safety chapters.

9.1 Inserting accessories

Use only suitable cookware and material. Refer to "Hints and tips" chapter, Microwave suitable cookware and materials.

A small indentation at the top increases safety. The indentations are also anti-tip devices. The high rim around the shelf prevents cookware from slipping off the shelf.

Wire shelf

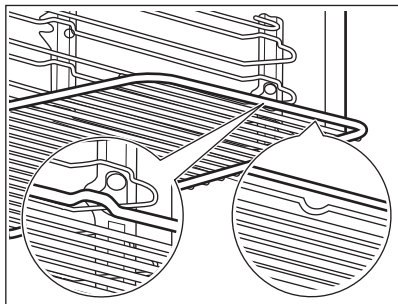

Insert the shelf between the guide bars of the shelf support and make sure that the feet point down.

Baking tray

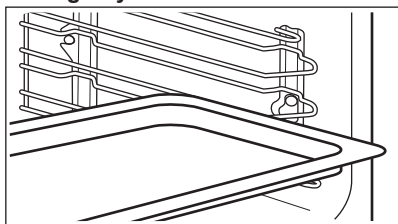

Push the tray between the guide bars of the shelf support.

Microwave bottom glass plate

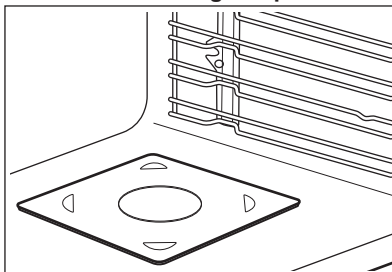

Use the microwave bottom glass plate only with microwave function. It is not suitable for combined microwave function (e.g. microwave grilling). Put the accessory on the bottom of the cavity. You can put the food directly on the microwave bottom glass plate.

10. HINTS AND TIPS

10.1 Cooking recommendations

The temperature and cooking times in the tables are for guidance only. They depend on the recipes, quality and quantity of the ingredients used.

Your appliance may bake or roast differently than your previous appliance. The hints below show recommended settings for temperature, cooking time and shelf position for specific types of the food.

If you cannot find the settings for a specific recipe, look for a similar one.

Symbols used in the tables:



Food type



Heating function



Temperature



Accessory



Weight (kg)



Microwave power (W)



Shelf position







Cooking time (min)

10.2 Information for test institutes

Microwave function

Tests according to IEC 60705.

Use wire shelf unless otherwise specified.







				
Sponge cake 1)	600	0.475	Bottom	7 - 9
Meatloaf 1)	400	0.9	2	25 - 32
Egg custard 1)	500	1	Bottom	18
Meat defrosting 2)	200	0.5	Bottom	7 - 8







1) Turn the container around by 1/4, halfway through the cooking time.

2) Turn the meat upside down halfway through defrosting time.

Microwave Combi Function

Use the wire shelf.

						
Cake 1)	Conventional Cooking + MW	100	0.7	200	2	23 - 27
Potato gratin 1)	True Fan Cooking + MW	300	1.1	180	2	38 - 42

						
Chicken 2)	Turbo Grilling + MW	400	1.1	230	1	35 - 40

- 1) Turn the container around by 1/4, halfway through the cooking time.
- 2) Put the meat in a round glass container and turn it upside down after 20 minutes of the cooking time.

10.3 Microwave recommendations

Place the food on the microwave bottom glass plate.

Place the food on a plate at the bottom of the oven.

Turn or stir the food halfway through the defrosting and cooking time.

Stir liquid dishes from time to time.

Stir the food before serving.

Cover the food for cooking and reheating.

Put the spoon to the bottle or glass when heating drinks to ensure better heat distribution.

Place the food into the appliance without packaging. The packaged ready meals can be put into the appliance only when the packaging is microwave safe (check information on the packaging).

Microwave cooking

Cover the food before cooking. If you want to keep a crust, cook food without a cover.

Do not overcook the dishes by setting the power and time too high. The food can dry out, burn or cause fire.

Do not use the appliance to cook eggs or snails in their shells, because they can burst.

Pierce the yolk of fried egg before reheating it.

Pierce food with skin or peel several times before cooking.

Cut vegetables into similar-sized pieces.

After you turn off the appliance, take the food out and let it stand for a few minutes to allow the heat distribute evenly.

Microwave defrosting

Place the frozen, unwrapped food on a small upturned plate with a container below it, or on a defrosting rack or plastic sieve so that the defrosting liquid can leak out.





Remove defrosted pieces subsequently.





To cook fruit and vegetables without defrosting them first, you can use a higher microwave power.

10.4 Microwave suitable cookware and materials

For the microwave use only suitable cookware and materials. Use below table as a reference.

Check the cookware / material specification before use.

Cookware / Material					
Ovenproof glass and porcelain with no metal components, e.g. heat-proof glass	✓	✓	✓	✓	✓
Non-ovenproof glass and porcelain without any silver, gold, platinum or other metal decorations	✓	✗	✗	✗	✗
Glass and glass ceramic made of ovenproof / frost-proof material	✓	✓	✓	✓	✓
Ovenproof ceramic and earthenware without any quartz or metal components and glazes which contain metal	✓	✓	✓	✓	✓

Cookware / Material		 	 
Ceramic, porcelain and earthenware with unglazed bottom or with small holes, e.g. on handles	X	X	X
Heat-resistant plastic up to 200 °C	✓	✓	X
Cardboard, paper	✓	X	X
Clingfilm	✓	X	X
Microwave clingfilm	✓	✓	X
Roasting dishes made of metal, e.g. enamel, cast iron	X	X	X
Baking tins, black lacquer or silicon-coated	X	X	X
Baking tray	X	X	X
Wire shelf	X	X	✓
Microwave glass bottom plate	✓	✓	X
Cookware for microwave use, e.g. crisp pan	X	✓	X

10.5 Power settings

Below data is for guidance only.

800 - 1000 W

- Searing at the start of the cooking process
- Heating up liquids

600 - 700 W

- Simmering rice
- Cooking vegetables
- Popcorn

400 - 500 W

- Heating one-plate meals

- Simmering stews
- Defrosting and heating ready frozen meals

300 W

- Cooking / Heating delicate food
- Heating baby food
- Continuing cooking

100 - 200 W

- Defrosting bread, fruit, cakes, pastries, cheese, butter, meat and fish
- Melting chocolate and butter

11. CARE AND CLEANING

WARNING!

Refer to Safety chapters.

11.1 Notes on cleaning

Cleaning Agents

- Clean the front of the appliance only with a microfibre cloth with warm water and a mild detergent.

- Use a cleaning solution to clean metal surfaces.
- Clean stains with a mild detergent.

Everyday Use

- Clean the interior of the appliance after each use. Fat accumulation or other residue may cause fire.
- Clean the appliance ceiling carefully from residue and fat.
- Do not store food in the appliance for longer than 20 minutes. Dry the interior of

the appliance only with a microfibre cloth after each use.

Accessories

- Clean all accessories after each use and let them dry. Use only a microfibre cloth with warm water and a mild detergent. Do not clean the accessories in a dishwasher.
- Do not clean the non-stick accessories using abrasive cleaner or sharp-edged objects.

11.2 Removing the shelf supports

Remove the shelf supports to clean the appliance.

1. Turn off the appliance and wait until it is cold.
2. Carefully pull the shelf supports up and out of the front catch.
3. Pull the front end of the shelf support away from the side wall.
4. Pull the supports out of the rear catch.

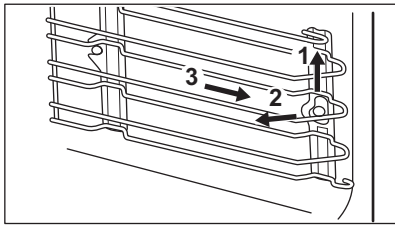

Install the shelf supports in the opposite sequence.

11.3 Replacing the lamp

⚠ WARNING!

Risk of electric shock.
The lamp can be hot.

1. Turn off the appliance and wait until it is cold.
2. Disconnect the appliance from the mains.
3. Place the cloth on the oven floor.

⚠ CAUTION!

Always hold the halogen lamp with a cloth to prevent grease residue from burning on the lamp.

Top lamp

1. Turn the glass cover to remove it.
2. Clean the glass cover.
3. Replace the lamp with a suitable 300 °C heat-resistant lamp.
4. Install the glass cover.

12. TROUBLESHOOTING

⚠ WARNING!

Refer to Safety chapters.

12.1 What to do if...

Problem	Check if...
You cannot activate or operate the appliance.	The appliance is correctly connected to an electrical supply.
The appliance does not heat up.	The automatic switch-off is deactivated.
The appliance does not heat up.	The fuse is not blown.
The appliance does not heat up.	Lock is deactivated.
The lamp does not work.	The lamp is burnt out.
The display shows 00:00.	There was a power cut. Set the time of day.



If the display shows an error code that is not in this table, turn the house fuse off and on to restart the appliance. If the error code recurs contact an Authorised Service Centre.

12.2 Service data

If you cannot find a solution to the problem yourself, contact your dealer or an Authorised Service Centre.

The necessary data for the service centre is on the rating plate. The rating plate is located on the front frame of the appliance. It is visible when you open the door. Do not remove the rating plate from the appliance.

We recommend that you write the data here:

Model (MOD.):

Product number (PNC):

Serial number (S.N.):

13. ENERGY EFFICIENCY

13.1 Energy saving

Make sure that the appliance door is closed when the appliance operates. Do not open the appliance door too often during cooking. Keep the door gasket clean and make sure it is well fixed in its position.

Use metal cookware to improve energy saving (only when you use a non-microwave function).

When possible, do not preheat the appliance before cooking.

Keep breaks between baking as short as possible when you prepare a few dishes at one time.

Cooking with fan

When possible, use the cooking functions with fan to save energy.

Residual heat

The fan and lamp continue to operate. When you turn off the appliance, the display shows

the residual heat. You can use that heat to keep the food warm.

When the cooking duration is longer than 30 min, reduce the appliance temperature to minimum 3 - 10 min before the end of cooking. The residual heat inside the appliance will continue to cook.

Use the residual heat to warm up other dishes.

Keep food warm

Choose the lowest possible temperature setting to use residual heat and keep a meal warm. The residual heat indicator or temperature appears on the display.

Cooking with the lamp off

Turn off the lamp during cooking. Turn it on only when you need it.

14. ENVIRONMENTAL CONCERNS

Recycle materials with the symbol . Put the packaging in relevant containers to recycle it. Help protect the environment and human health by recycling waste of electrical and electronic appliances. Do not dispose of

appliances marked with the symbol  with the household waste. Return the product to your local recycling facility or contact your municipal office.





aeg.com

867380128-C-512023



UK
CA CE