

**IMPORTANT: PUT ALL SCREWS INTO PLACE BEFORE TIGHTENING EACH ONE GRADUALLY IN SEQUENCE.
THIS IS IMPORTANT TO ENSURE THAT ALL THE BOLTS LINE UP CORRECTLY TO START WITH**

ASSEMBLY & PRODUCT CARE

LOUNGE CHAIR WITH FOOTSTOOL

5056693518440

Thank you for purchasing this PRODUCT. Please read the instructions carefully before use to ensure safe and satisfactory operation of this product.

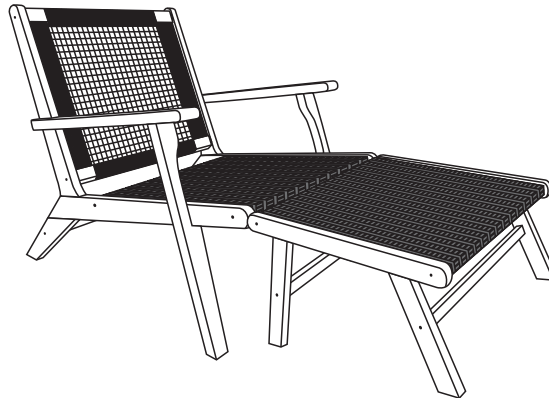

Pre-assembly preparation

Please ensure instructions are read in full before attempting to assemble this product

You will need

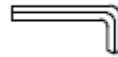

Allen Key (included)

Please check the pack contents before attempting to assemble this product. A full checklist of components is given in this leaflet. If any components are missing, please contact the retailer from whom you bought this product.

This product is **HEAVY**, it should be assembled as near as possible to the point of use. **TAKE CARE WHEN LIFTING** to avoid personal injury and (or) damage to the product.







This product takes approximately **30 MINUTES** to assemble with **2 PEOPLE**.

The fittings pack contains **SMALL ITEMS** which should be **KEPT AWAY FROM YOUNG CHILDREN**.

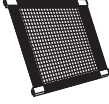
Read this leaflet in full before commencing assembly.

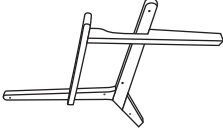
**IMPORTANT: PUT ALL SCREWS INTO PLACE BEFORE TIGHTENING EACH ONE GRADUALLY IN SEQUENCE.
THIS IS IMPORTANT TO ENSURE THAT ALL THE BOLTS LINE UP CORRECTLY TO START WITH**

Fittings and parts checklist

Part	Description	Image	Qty
A	Back		1
B	Seat		1
C	Legs		2
D	Stretcher Rails		1
1	M6x60mm Screw		10
2	Allen Key		1

**IMPORTANT: PUT ALL SCREWS INTO PLACE BEFORE TIGHTENING EACH ONE GRADUALLY IN SEQUENCE.
THIS IS IMPORTANT TO ENSURE THAT ALL THE BOLTS LINE UP CORRECTLY TO START WITH**

Step by step assembly instructions

Step One

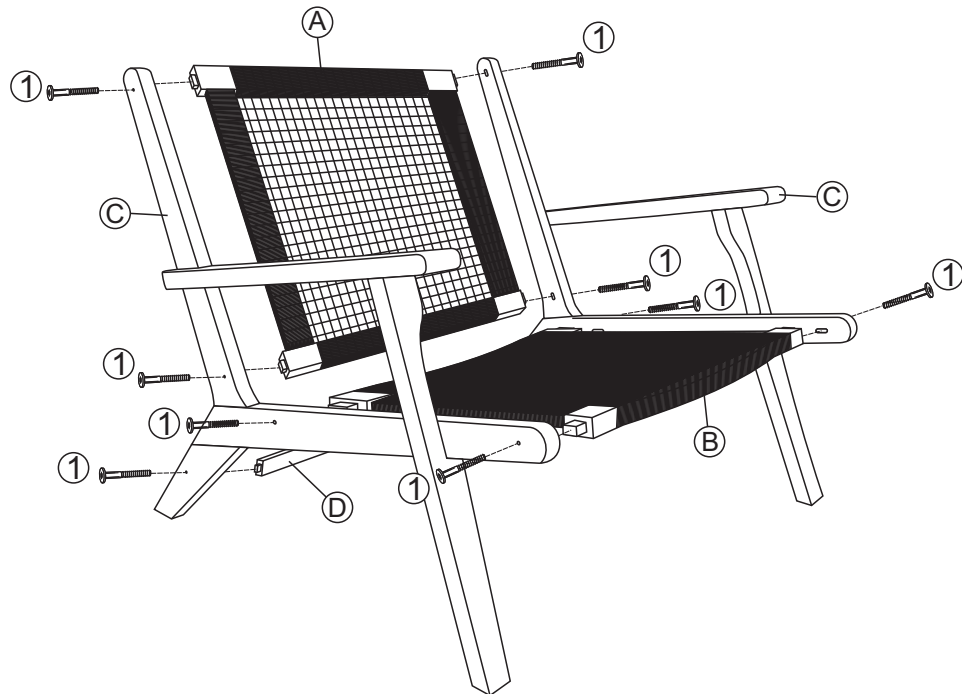

IMPORTANT: We would advise that at this stage the top remains inside the original packaging, or lay onto a clean carpet or blanket to avoid damage to the surface.





Step Two

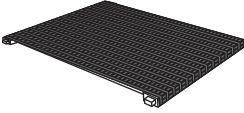
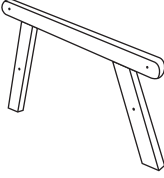

IMPORTANT: We would advise that at this stage the top remains inside the original packaging, or lay onto a clean carpet or blanket to avoid damage to the surface.

**IMPORTANT: PUT ALL SCREWS INTO PLACE BEFORE TIGHTENING EACH ONE GRADUALLY IN SEQUENCE.
THIS IS IMPORTANT TO ENSURE THAT ALL THE BOLTS LINE UP CORRECTLY TO START WITH**

Fittings and parts checklist

Part	Description	Image	Qty
A	Plate of Footrest		1
B	Ress of Footrest		2
C	Stretcher Rails		2
1	M6x60mm Screw		8
2	Allen Key		1

**IMPORTANT: PUT ALL SCREWS INTO PLACE BEFORE TIGHTENING EACH ONE GRADUALLY IN SEQUENCE.
THIS IS IMPORTANT TO ENSURE THAT ALL THE BOLTS LINE UP CORRECTLY TO START WITH**

Step by step assembly instructions

Step One

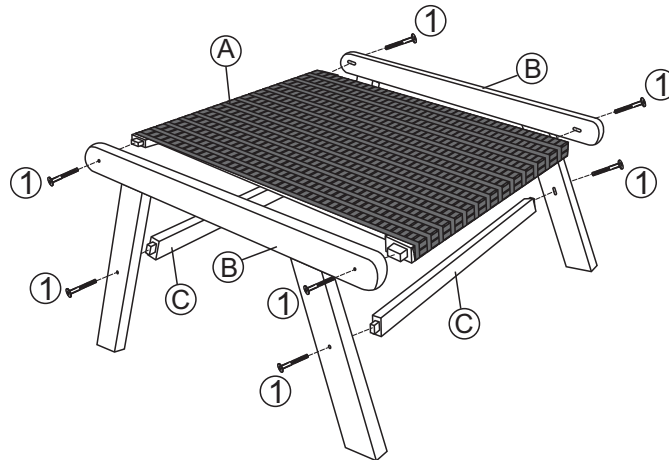

IMPORTANT: We would advise that at this stage the top remains inside the original packaging, or lay onto a clean carpet or blanket to avoid damage to the surface.

Step Two

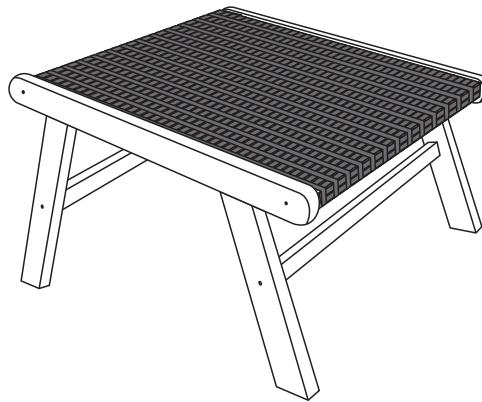

IMPORTANT: We would advise that at this stage the top remains inside the original packaging, or lay onto a clean carpet or blanket to avoid damage to the surface.

Step Three

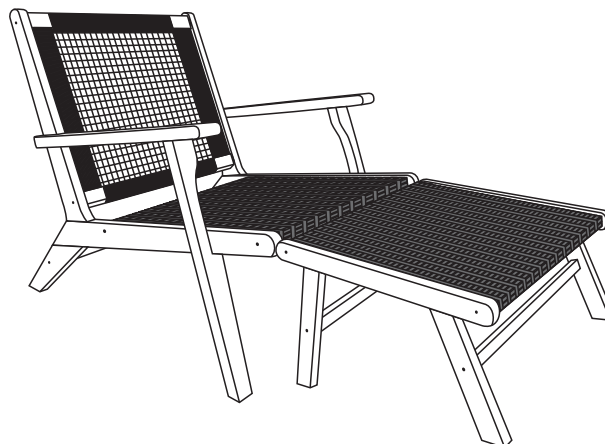

IMPORTANT: We would advise that at this stage the top remains inside the original packaging, or lay onto a clean carpet or blanket to avoid damage to the surface.

**IMPORTANT: PUT ALL SCREWS INTO PLACE BEFORE TIGHTENING EACH ONE GRADUALLY IN SEQUENCE.
THIS IS IMPORTANT TO ENSURE THAT ALL THE BOLTS LINE UP CORRECTLY TO START WITH**

OUTDOOR FURNITURE

Thank you for purchase, we hope you enjoy your furniture for the upcoming summer and years to come. Below are a few points about your furniture, please read and retain for future reference.

Safety Instructions

Furniture can be dangerous if incorrectly installed. Assembly should be carried out by a competent person. No liability will be accepted for damage or injury caused by incorrectly installed or assembled furniture.

Moving Furniture:

Never drag furniture when moving it, always lift it.

When lifting or moving a table always do so from under frame and not the table top.

Periodically check all fixings to ensure none have come loose and re-tighten where necessary.

Please take care when handling or moving the furniture as careless handling may cause damage or injury.

It is recommended that before moving heavy objects to a new location they are completely disassembled to avoid personal injury or damage to the furniture. Please be careful to retain all fittings when doing this.

Load Caution:

Never overload an item such as a shelf that may be beyond what the shelf is reasonably expected to hold.

Please do not sit or place an amount of weight onto the edge of a tabletop as this may cause the table to topple.

Single Chairs/Arm Chairs are designed for sitting one person only. Sit whilst supporting your back only at a resting position. If any parts are missing or damaged, please stop using Chair until parts are replaced. **WARNING: DO NOT USE CHAIRS TO STAND ON. DO NOT ROCK OR TOPPLE CHAIR BACKWARDS.**

Treatment:

We recommend that when applying oil, mineral spirits, or bleach, gloves and safety goggles are worn.

IMPORTANT: PUT ALL SCREWS INTO PLACE BEFORE TIGHTENING EACH ONE GRADUALLY IN SEQUENCE. THIS IS IMPORTANT TO ENSURE THAT ALL THE BOLTS LINE UP CORRECTLY TO START WITH

Care and Maintenance

WHEN CARED FOR PROPERLY, THIS HAND CRAFTED FURNITURE WILL PROVIDE YOU WITH YEARS OF ENJOYMENT AT YOUR HOME.

If your furniture requires assembly, put all screws into place before tightening each one gradually in sequence. This is important to ensure that all the bolts line up correctly to start with.

The frame of the furniture is all-weather proof. However, although cushions are showerproof, you will need to store your cushions away when not in use to keep them at their best. They can be sponge cleaned with a gentle detergent. Avoid machine washing as this may affect the Fire Retardant coating.

We recommend using a parasol over dining sets on sunny days to protect from direct sunlight. In Windy conditions don't forget to store your furniture away especially a parasol.

Glass

If your furniture includes glass, please note that it is tempered glass. This is a toughened safety glass so in case of an accident it crumbles to a safe shape rather than breaking into dangerous shards.

Be aware that if a liquid is on the glass to mop it up immediately, because when it is in direct sunlight it can act as a magnifier and can cause the frame under the Glass to melt, especially Rattan.

When moving your furniture ensure that it is carried and not dragged as this weakens the glass. If you remove the glass, lay it flat onto a soft protective surface like a blanket, rather than upright to avoid chipping, and always onto a soft protective blanket.

REMEMBER:

1. Do not use the glass as a chopping surface. Do not strike the glass with hard or pointed objects.
2. Do not sit or stand on horizontal glass surfaces.
3. Do not place very hot or very cold items against or in close proximity to glass surface(s).
4. The surface should be protected with coasters, trivets or placemats.
5. All spills should be blotted up immediately. Do not wipe the spill or this may spread it. Clean the surface with a clean soft cloth (non-abrasive) and mild detergent or stone soap.

IMPORTANT: PUT ALL SCREWS INTO PLACE BEFORE TIGHTENING EACH ONE GRADUALLY IN SEQUENCE. THIS IS IMPORTANT TO ENSURE THAT ALL THE BOLTS LINE UP CORRECTLY TO START WITH

Metal (Outdoor)

Metal furniture is weatherproof powder coated paint which requires minimal maintenance:

Cleaning your metal furniture is very simple. Use a soft cotton cloth and clean with mild detergent or water, using a towel immediately dry the furniture afterwards.

Due to the outdoor nature of these products, some rusting is to be expected. This is the natural aging process of these products. Metal furniture is usually damaged due to rust, as a precaution a soft wax after cleaning will help seal it.

If it has a few spots of rust, you can treat it with rust remover, following the manufacturers guidelines. (some finishes are made to look like rust)

Smudges and smears can be removed from metal furniture by using a window cleaner and a paper towel.

Rattan

If product has Rattan, you may find that the end of the weave has become loose, this isn't a manufacturing error it is the end of the weave and simply needs to be tucked back into place. Your product has been individually woven by hand therefore a uniform appearance is unlikely, a slant to the weave is common with a rattan item especially with different tones of weave.

Rope

If product includes rope, you may find that the end of the weave has become loose, this isn't a manufacturing error it is the end of the weave and simply needs to be tucked back into place. Your product has been individually woven by hand therefore a uniform appearance is unlikely, a slant to the weave is common with a rope item especially with different tones of weave.

Teak Wood, unpainted (Outdoor)

If your furniture is made of Teak, it is Genuine Teak Wood (*Tectona grandis*). The teak wood species has natural inherent content of oils that are resistant to moisture and deterioration. The oil in the wood protects the wood against the absorption of water and helps the surface stay clean.

The teak wood used to produce this furniture comes from medium sized plantations. Each piece of furniture is handcrafted by expert wood craftsmen, therefore, each piece is an original creation.

IMPORTANT: PUT ALL SCREWS INTO PLACE BEFORE TIGHTENING EACH ONE GRADUALLY IN SEQUENCE. THIS IS IMPORTANT TO ENSURE THAT ALL THE BOLTS LINE UP CORRECTLY TO START WITH

Teak wood naturally expands and contracts when exposed to the elements and over time cracks may appear on the surface. This is a natural occurrence and will not jeopardise or impair the stability and integrity of the teak wood.

Care and Use Instructions:

Teak wood left untouched over 9-12 months period will begin to turn to a silver grey color, if this color is preferred no maintenance is required. However we do recommend that dirt or debris be cleaned as necessary following below instructions.

When desired your furniture can be washed with a mild solution of dish washing soap and warm water. Never use sharp items on the surface of the product. For example knives and utensils may damage the product. It is also advisable to place a mat under paper when writing.

If you wish to keep the original finish we recommend that you clean the wood furniture as recommended above, then apply a high quality teak oil with a soft bristle paint brush or a clean white cotton cloth, apply evenly and thoroughly let the surface dry for at least two hours, wipe any excess teak oil remaining on the surface with a clean white cotton cloth.

Other Wood, unpainted (Outdoor)

Never use sharp items on the surface of the product. For example knives and utensils may damage the product. Make sure all surfaces are protected from heat and liquids by mats and coasters. Wipe up spills immediately and ensure that a mat or pad is placed under paper if you are writing.

Extendable dining tables should be left extended for the first few months to avoid an uneven appearance.

Furniture with a hard lacquer, wax polish or painted surface should be dusted with a dry cloth.

Waxed furniture will need to be given a coat of beeswax a couple of times a year to help maintain its luster.

Spray polishes are best avoided as they contain silicones which may spoil the furniture's surface by building up over time.

**IMPORTANT: PUT ALL SCREWS INTO PLACE BEFORE TIGHTENING EACH ONE GRADUALLY IN SEQUENCE.
THIS IS IMPORTANT TO ENSURE THAT ALL THE BOLTS LINE UP CORRECTLY TO START WITH**

Painted Wood (Outdoor)

Never use sharp items on the surface of the product. For example knives and utensils may damage the product. Make sure all surfaces are protected from heat and liquids by mats and coasters. Wipe up spills immediately and ensure that a mat or pad is placed under paper if you are writing.

Extendable dining tables should be left extended for the first few months to avoid an uneven appearance.

Hand painted brush stroke finishes will hold up to everyday wear and tear quite nicely. However, it is important to remember that your piece is still a wood piece of furniture and should be cared for as such.

Painted furniture still requires regular dusting with a damp cloth. When very soiled wash with a solution of mild, non-abrasive detergent and warm water. Wring a cloth nearly dry and work on a small section at a time, then rinse with clear water drying after.

Never leave water to settle on the surface as this will cause damage. Any liquid spilled onto the item should be cleaned up immediately using an absorbent cloth.

AVOID chemical cleaners or liquid furniture polish including direct contact with greasy substances. As with all natural wood products, there will be some movement within the parts as the furniture acclimatizes to its surroundings, you may see slight chipping and cracks where panels meet, this is a completely natural occurrence with ALL painted products using natural solid timbers.

Painted surfaces can be carefully touched up with matching paint.

There will be various brush lines, slubs, and little inconsistencies in the painted finish, this is all part of the relaxed handfinished look and feel of hand painted collections.

WHEN CARED FOR PROPERLY, THIS HAND CRAFTED FURNITURE WILL PROVIDE YOU WITH YEARS OF ENJOYMENT AT YOUR HOME.

PLEASE KEEP THESE INSTRUCTIONS FOR FUTURE REFERENCE
