

Product information

- Indoor use only
- Dimmable - When used with dimmable bulbs
- Replacement bulbs should be the same type and rating, available from John Lewis Partners or other established brands
- Clean the fitting with a soft dry cloth. Do not use abrasive chemical cleaners as this will damage the finish

Aftercare and Troubleshooting

You've switched on the light, but it's not working:

1. Check your power supply is switched on
2. Turn off the light and check that the bulb is inserted correctly
3. Check the bulb is still in working order

If there are technical issues with this product that you can't solve, please contact your nearest John Lewis & Partners shop or call Technical Support on 03301 230106.

Specification

Max power: 3 x 7W
Recommended bulb: 7W LED GU10 bulb for maximum brightness.
Lower wattages are also suitable.
Rated input: 220 –240V, 50Hz
Bulbs not included
IP rating: 20
Weight: 1.95kg

Fitting a GU10 bulb

Fit bulb pins into round holes.
Then twist clockwise to lock.

Ensure the bulb fitting tool is clean prior to fitting the bulb.
Any traces of dust can be wiped away with a damp cloth.

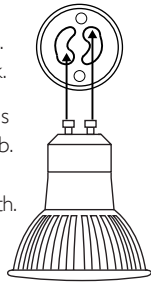

5-year guarantee

At John Lewis & Partners we test every light to high quality standards. That means we can offer you a 5-year guarantee.

Recycling

This symbol  indicates that this product should not be treated as normal household waste and it should be recycled. John Lewis & Partners do not operate instore take back, but as members of the Distributor Take Back scheme have funded the development and upgrade of recycling facilities across the UK. Please take it to your nearest collection facility or for further details contact your local council or visit www.recycle-more.co.uk.

John Lewis plc
SW1V 2QQ
johnlewis.com

Made in China



15/10/2024

Please retain these instructions for future reference.



OBI 3 LIGHT SPOTLIGHT PLATE USER GUIDE

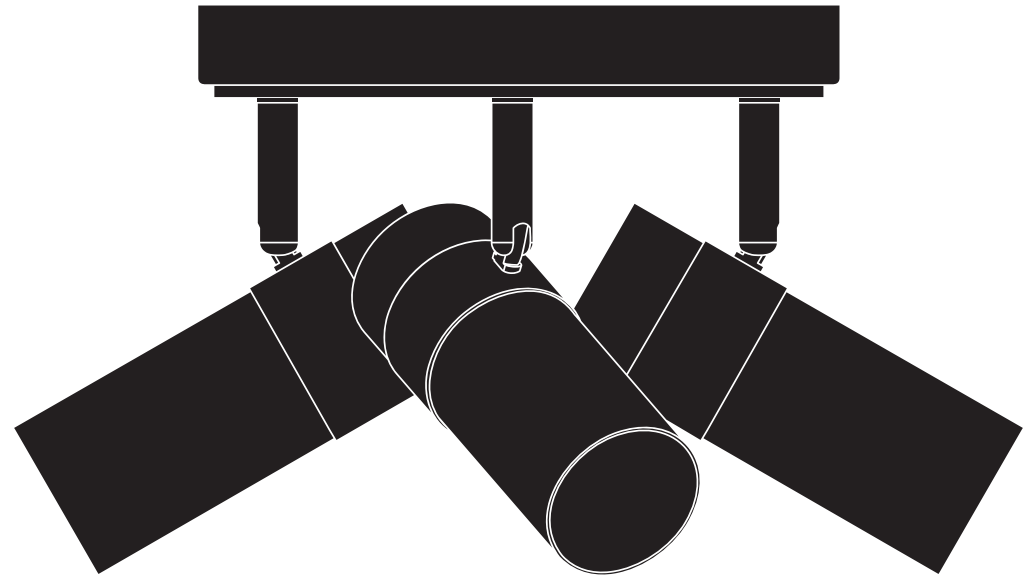

Product Code:
10522209

Getting started

Thank you for purchasing this John Lewis & Partners product. For your safety, and to make sure everything is working properly, please read the instructions carefully before use.

Warnings

This is a Class 1 product and must be earthed. It is recommended that this fitting is installed by a qualified electrician. Install in accordance with the IEE Wiring regulations and the Building Regulations. To prevent electrocution switch off at mains supply before installing or maintaining this fitting. Ensure other persons cannot restore the electrical supply without your knowledge. If you are in any doubt, please consult a qualified electrician. This light fitting should be connected to a 5 amp fused circuit. If replacing an existing fitting, make a note of the connections. Always use the correct type and wattage bulb. Never exceed the wattage stated. Dispose of used bulbs carefully. GU10 LED bulbs up to 7W can be used - but ensure that the minimum distance to the illuminated surface is not less than 0.5m (50 cm). This product is suitable for installation on surfaces with normal flammability e.g. wood, plasterboard, masonry. It is not suitable for use on highly flammable surfaces (e.g. polystyrene, textiles). For your safety, always switch off the supply and allow the fitting to cool down before changing lightbulbs, cleaning or adjusting heads.

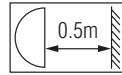

Parts list

Description	Image	Quantity
Light fitting		x 1
Bulb fitting tool		x 1
Wall plugs		x 2
Screws		x 2

Product assembly

Step 1

Carefully unpack the carton, making sure all the parts are present before assembly. Before removing the existing fitting, carefully note the position of each set of wires.

Step 2

Remove the fixing bracket (A) from the product by loosening the two side screws (B).

Ensure there is a solid mounting surface to support the weight of the light fitting. Using the fixing bracket as a template, mark the position of the mounting holes. Drill holes and fit supplied wall plugs (C) (suitable for masonry only). Take care to avoid damaging any concealed wiring and pipes.

Fix the bracket to the ceiling using supplied screws (D).

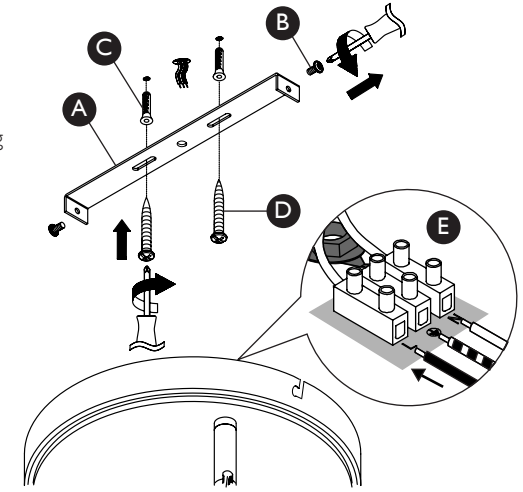

Step 3

Having identified the household wiring from your existing light fitting, connect to the connection block inside the product in the following way (E). Check that: You have correctly identified the house wires.

The connections are tight.

No loose strands have been left out of the connection block.

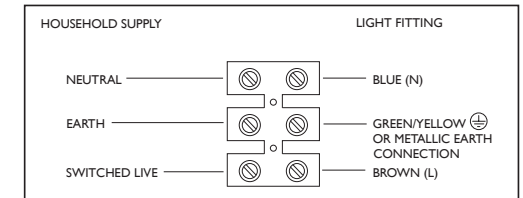

Step 4

This product has "L" shaped fixing slots to allow easy fixing to the fixing bracket. Locate the "L" slots (F) around the small screws (B) on the fixing bracket (A). Rotate the ceiling cover to attach the product to the bracket. Tighten the screws to secure. Take care not to trap any wiring.

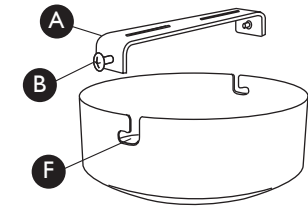

Step 5

Using the supplied tool (G) fit the recommended bulbs (H) as per the details overleaf.

Step 6

Your light is now ready for use.

Note:

The angle of the heads can be adjusted to the appropriate angle as needed.

