

## Product information

- Indoor use only
- Dimmable - When used with dimmable bulbs
- Replacement bulbs should be the same type and rating, available from John Lewis Partners or other established brands
- Clean the fitting with a soft dry cloth. Do not use abrasive chemical cleaners as this will damage the finish
- Glass parts - Use a damp cloth. Do not use abrasive materials as these will damage the finish. Take care when handling glass parts to avoid damage or injury

## Aftercare and Troubleshooting

### You've switched on the light, but it's not working:

1. Check your power supply is switched on
2. Turn off the light and check that the bulb is inserted correctly
3. Check the bulb is still in working order

If there are technical issues with this product that you can't solve, please contact your nearest John Lewis & Partners shop or call Technical Support on 03301 230106.

## Specification

Max power: 3 x 6W  
Recommended bulb:  
3 x 6W E14 Candle LED bulb for maximum brightness.  
Lower wattages are also suitable.  
Rated input: 220 -240V, 50Hz  
Bulbs not included  
IP rating: 20  
Weight: 1.25kg

## 5-year guarantee

At John Lewis & Partners we test every light to high quality standards. That means we can offer you a 5-year guarantee.

## Recycling

This symbol  indicates that this product should not be treated as normal household waste and it should be recycled. John Lewis & Partners do not operate instore take back, but as members of the Distributor Take Back scheme have funded the development and upgrade of recycling facilities across the UK. Please take it to your nearest collection facility or for further details contact your local council or visit [www.recycle-more.co.uk](http://www.recycle-more.co.uk).

John Lewis Plc  
171 Victoria Street  
London SW1E 5NN  
[johnlewis.com](http://johnlewis.com)

Made in China



03/04/2023

Please retain these instructions for future reference.



# HAVERSTOCK 3 LIGHT CEILING PENDANT USER GUIDE

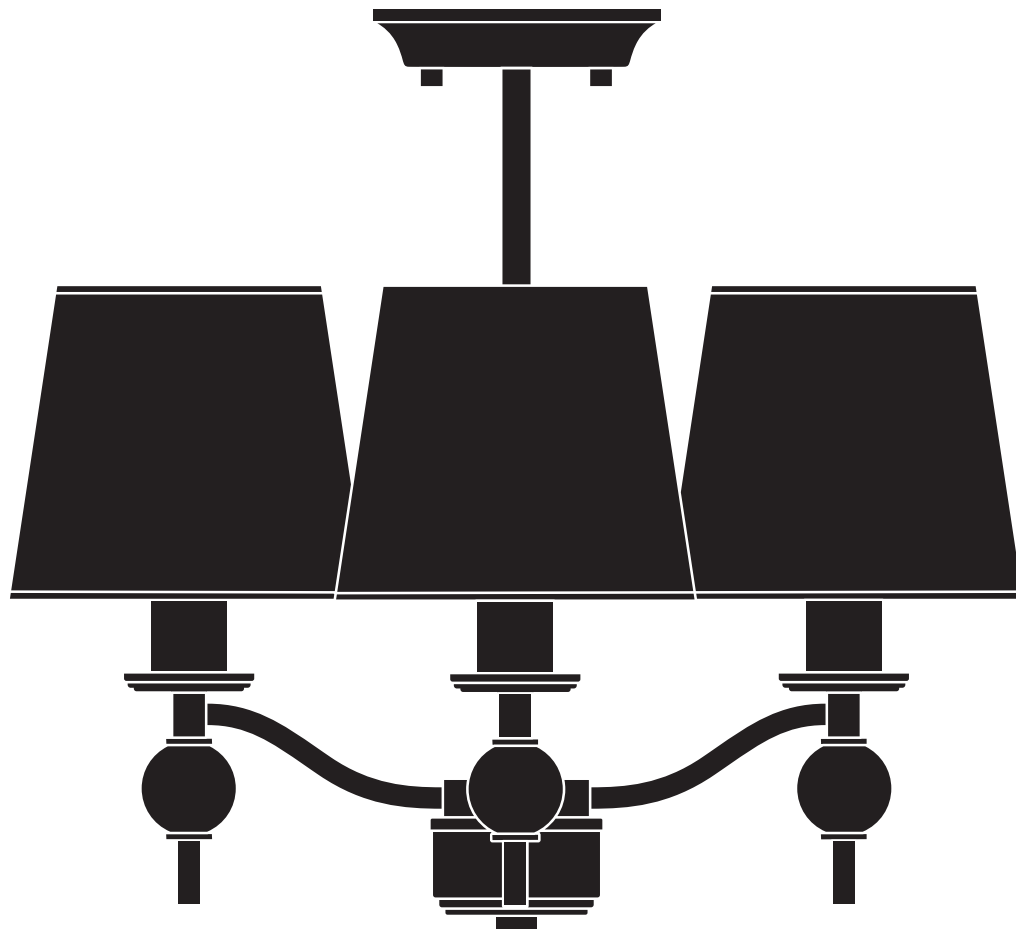

Product Code:  
70150704





## Getting started

Thank you for purchasing this John Lewis & Partners product. For your safety, and to make sure everything is working properly, please read the instructions carefully before use.

## Warnings

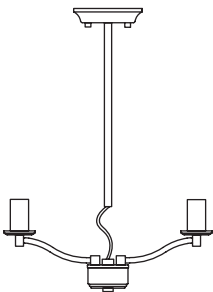
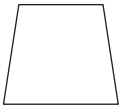
This is a Class 1 product and must be earthed. It is recommended that this fitting is installed by a qualified electrician. Install in accordance with the IEE Wiring regulations and the Building Regulations. To prevent electrocution switch off at mains supply before installing or maintaining this fitting. Ensure other persons cannot restore the electrical supply without your knowledge. If you are in any doubt, please consult a qualified electrician. This light fitting should be connected to a 5 amp fused circuit. If replacing an existing fitting, make a note of the connections. Always use the correct type and wattage bulb. Never exceed the wattage stated. Dispose of used bulbs carefully. This product is suitable for installation on surfaces with normal flammability e.g. wood, plasterboard, masonry. It is not suitable for use on highly flammable surfaces (e.g. polystyrene, textiles). For your safety, always switch off the supply and allow the fitting to cool down before changing lightbulbs, cleaning or removing shades.

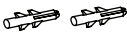
## Parts list

Description	Image	Quantity
Light fitting		x 1
Shades		x 3
Decorative glass balls		x 3
Wall plugs		x 2
Screws		x 2

## Product assembly

### Step 1

Carefully unpack the carton, making sure all the parts are present before assembly. Before removing the existing fitting, carefully note the position of each set of wires.

### Step 2

Attach the stem by screwing the stem in a clockwise direction, into the threaded part of the body (A). Pull any excess cable through from the top of the ceiling cup. It may be necessary to turn the stem anticlockwise before fixing into place to avoid twisting the internal cable. Tighten to secure. Take care not to rotate more than 360° when installing and in use.

### Step 3

Screw the decorative glass balls in a clockwise direction, onto the bottom of each lampholder (B).

### Step 4

Remove the fixing bracket (C) from the ceiling cover by removing the two finials (D). Attach to the ceiling using the screws provided (E). Ensure there is a joist at the point of fixing to support the weight of the product. Take care to avoid damaging any concealed wiring and pipes.

### Step 5

Having identified the household wiring from your existing light fitting, connect to the connection block inside the product in the following way. Check that: You have correctly identified the house wires. The connections are tight. No loose strands have been left out of the connection block.

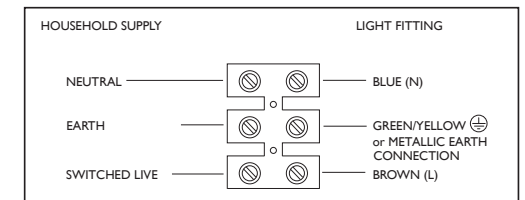
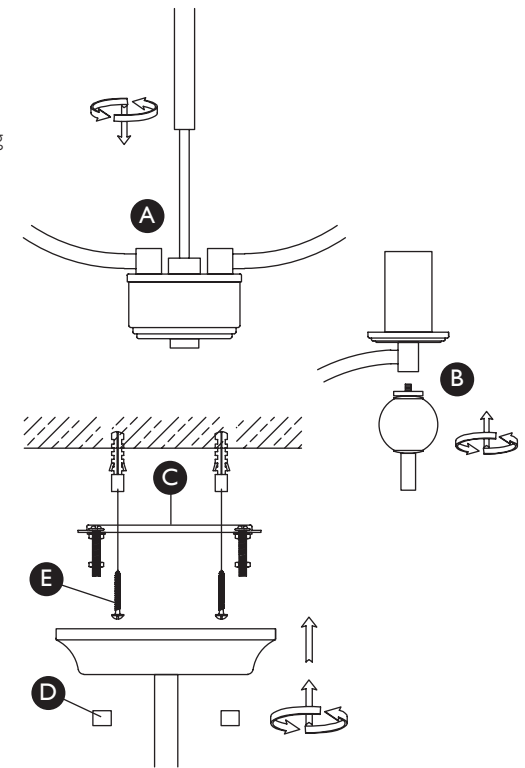

### Step 6

Re attach the product to the fixing bracket using the two finials removed in step 4. Tighten to secure.

### Step 7

Fit the recommended bulbs (F) as per the details overleaf.

### Step 8

To attach the shades (G), gently push the shade clips (H) inside the shade onto the bulbs.

### Step 9

Replace fuse or circuit breaker and switch on. Your light is now ready for use.

