

## Product information

- Indoor use only
- Dimmable - When used with dimmable bulbs
- Replacement bulbs should be the same type and rating, available from John Lewis Partners or other established brands
- Clean the fitting with a soft dry cloth. Do not use abrasive chemical cleaners as this will damage the finish
- Glass parts - Use a damp cloth. Do not use abrasive materials as these will damage the finish. Take care when handling glass parts to avoid damage or injury

## Aftercare and Troubleshooting

### You've switched on the light, but it's not working:

1. Check your power supply is switched on
2. Turn off the light and check that the bulb is inserted correctly
3. Check the bulb is still in working order

If there are technical issues with this product that you can't solve, please contact your nearest John Lewis & Partners shop or call Technical Support on 03301 230106.

## Specification

Max power: 7W  
Recommended bulb:  
1 x 7W E27 GLS LED bulb for maximum brightness.  
Lower wattages are also available.  
Rated input: 220 -240V, 50Hz  
Bulbs not included  
IP rating: 20  
Weight: 0.95kg

## 5-year guarantee

At John Lewis & Partners we test every light to high quality standards. That means we can offer you a 5-year guarantee.

## Recycling

This symbol  indicates that this product should not be treated as normal household waste and it should be recycled. John Lewis & Partners do not operate instore take back, but as members of the Distributor Take Back scheme have funded the development and upgrade of recycling facilities across the UK. Please take it to your nearest collection facility or for further details contact your local council or visit [www.recycle-more.co.uk](http://www.recycle-more.co.uk).

John Lewis Plc  
171 Victoria Street  
London SW1E 5NN  
[johnlewis.com](http://johnlewis.com)

Made in China



17/04/2023

Please retain these instructions for future reference.



# TULA OPALINE WALL LIGHT USER GUIDE

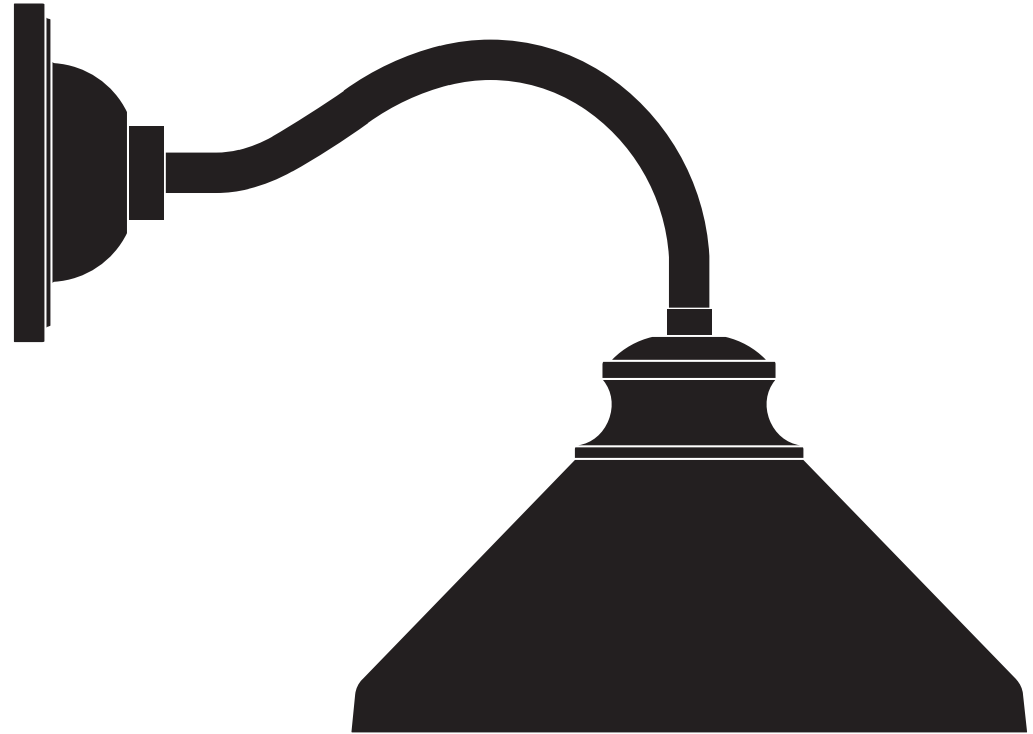

Product Code:  
70250803





## Getting started

Thank you for purchasing this John Lewis & Partners product. For your safety, and to make sure everything is working properly, please read the instructions carefully before use.

## Warnings

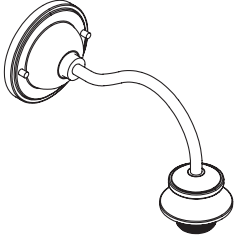
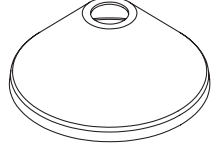
This is a Class 1 product and must be earthed. It is recommended that this fitting is installed by a qualified electrician. Install in accordance with the IEE Wiring regulations and the Building Regulations. To prevent electrocution switch off at mains supply before installing or maintaining this fitting. Ensure other persons cannot restore the electrical supply without your knowledge. If you are in any doubt, please consult a qualified electrician. This light fitting should be connected to a 5 amp fused circuit. If replacing an existing fitting, make a note of the connections. Always use the correct type and wattage bulb. Never exceed the wattage stated. Dispose of used bulbs carefully. This product is suitable for installation on surfaces with normal flammability e.g. wood, plasterboard, masonry. It is not suitable for use on highly flammable surfaces (e.g. polystyrene, textiles). For your safety, always switch off the supply and allow the fitting to cool down before changing lightbulbs, cleaning or removing shades.

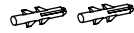
## Parts list

Description	Image	Quantity
Light fitting with shade ring (fitted)		x 1
Shade		x 1
Plastic washer		x 1
Wall plugs		x 2
Screws		x 2

## Product assembly

### Step 1

Refer to assembly diagrams right. Carefully unpack the carton, making sure all the parts are present before assembly. Before removing the existing fitting, carefully note the position of each set of wires.

### Step 2

Remove the fixing bracket (A) from the product by removing the two finials (B).

Ensure there is a solid mounting surface to support the weight of the light fitting. Using the fixing bracket as a template, mark the position of the mounting holes. Drill holes and fit supplied wall plugs (C). Take care to avoid damaging any concealed wiring and pipes. Fix the bracket to the wall using supplied screws (D).

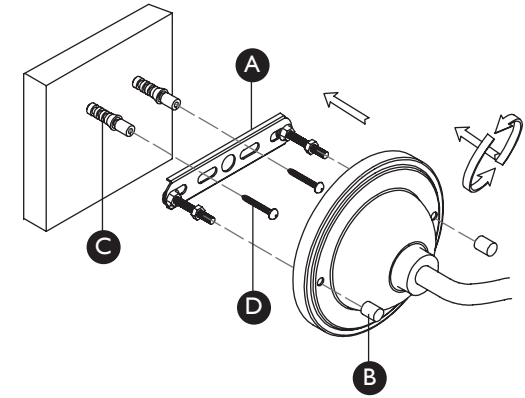

### Step 3

Having identified the household wiring from your existing light fitting, connect to the connection block inside the product in the following way. Check that: You have correctly identified the house wires. The connections are tight. No loose strands have been left out of the connection block.

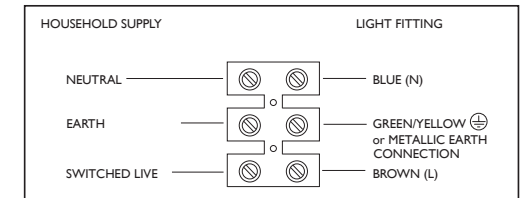

### Step 4

Making sure the product is facing downwards, re attach to the fixing bracket using the two finials removed in step 2 and tighten to secure. Take care not to trap any wiring.

### Step 5

To fit the shade (E), first remove the plastic washer (F) and shade ring (G) from the threaded lampholder. Place the shade over the lampholder and refit the plastic washer and shade ring. Secure in place.

### Step 6

Fit the recommended bulb (H) as per the details overleaf.

### Step 7

Replace fuse or circuit breaker and switch on. Your light is now ready for use.

