

Warnings!

Maximum load 3 kg. Do not exceed.

Do not allow children to pull or play with the Metal Shelf Set of 2 Mint Green.

Always follow the appropriate guidelines for the wall type to ensure product will be securely fixed. If in doubt, seek expert advice.

Do's

- ✓Check the pack and make sure you have all the parts listed.
- ✓Check all screws or bolts are tightened and inspect regularly.

Don'ts

- ✗Do not over tighten screws or bolts.
- ✗Do not use power tools to construct as over tightening may occur.

Care instructions

Wipe clean with a soft dry cloth.

John Lewis Plc
171 Victoria Street
London SW1E 5NN
johnlewis.com

Made in India

Please retain these instructions for future reference.



USER GUIDE METAL SHELF SET OF 2 MINT GREEN

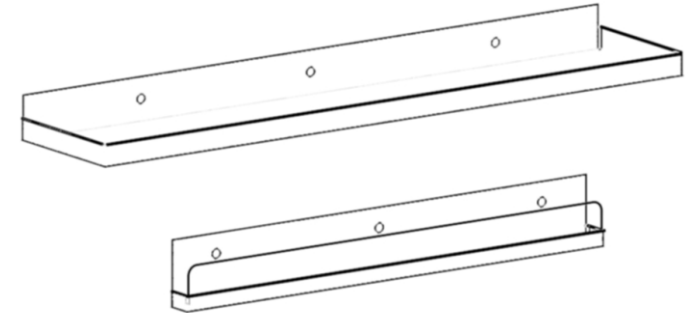

Thank you for purchasing this Metal Shelf Set of 2 Mint Green. Please read the instructions and warnings carefully before use to ensure safe and satisfactory operation of this product. Before beginning assembly, please ensure you have all parts outlined in the pack Contents below.

Pack contents

I. Product

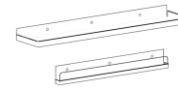

Assembly

Step-1

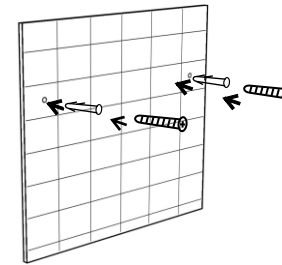

Place hook in desired location and ensure it is level
 Mark mounting hole locations
 Drill holes and insert rawl plugs
 Insert screws into rawl plugs leaving 5mm overhang

Step-2

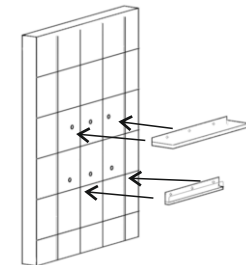

Place hooks just above screws, aligning keyhole slots over screws & then slot coat hook into place in a downwards motion

Step-3

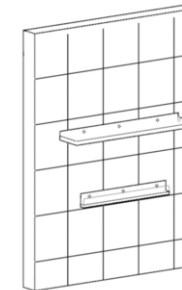

Ensure product is securely fixed in place prior to use

⚠ Warning - A guide to wall mounting and fixings

Please ensure you use the correct screws / fixings for your type of walls and seek professional advice if you are not sure.

Failure of the product due to incorrect fixings is the responsibility of the installer.

Important: When drilling into the walls always check that there are no hidden wires or pipes etc.

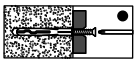

Types of walls
 You can use one of the following types of wall plug if your walls are made of brick, breezeblock, concrete, stone or wood.

1. General Purpose wall plug
 Generally aerated blocks should not be used to support heavy loads, use a specialist fitting in this case. For light loads, general - purpose wall plugs can be used.

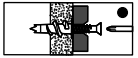

2. Plasterboard wall plug
 For use when attaching light loads on to plasterboard partitions.

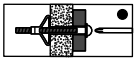

3. Cavity Fixing wall plug
 For use with plasterboard partitions or hollow wooden doors.



4. Cavity Fixing - Heavy Duty wall plug
 For use when fitting or supporting heavy loads such as shelving, wall cabinets and coat racks.

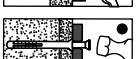

5. Hammer Fixing wall plug
 For use with walls stuck with plasterboard. The hammer fixing allows it to be fixed to the wall rather than the plasterboard. Always check the fixing is secure to the retaining wall.



6. Shield Anchor wall plug - Heavy loads
 For use with heavier loads such as TV and Hi-Fi speakers and satellite dishes etc.

⚠ Care and maintenance
 Safety: Periodically check all fittings and wall fixings to ensure they have not come loose and retighten as necessary